

AFG2021
Arbitrary Function Generator
Service Manual



077-0586-00

Tektronix

AFG2021
Arbitrary Function Generator
Service Manual

Copyright © Tektronix. All rights reserved. Licensed software products are owned by Tektronix or its subsidiaries or suppliers, and are protected by national copyright laws and international treaty provisions.

Tektronix products are covered by U.S. and foreign patents, issued and pending. Information in this publication supersedes that in all previously published material. Specifications and price change privileges reserved.

TEKTRONIX and TEK are registered trademarks of Tektronix, Inc.

Additional trademark statements can be added here.

Contacting Tektronix

Tektronix, Inc.
14150 SW Karl Braun Drive
P.O. Box 500
Beaverton, OR 97077
USA

For product information, sales, service, and technical support:

- In North America, call 1-800-833-9200.
- Worldwide, visit www.tektronix.com to find contacts in your area.

Warranty

Tektronix warrants that the product will be free from defects in materials and workmanship for a period of three (3) years from the date of original purchase from an authorized Tektronix distributor. If the product proves defective during this warranty period, Tektronix, at its option, either will repair the defective product without charge for parts and labor, or will provide a replacement in exchange for the defective product. Batteries are excluded from this warranty. Parts, modules and replacement products used by Tektronix for warranty work may be new or reconditioned to like new performance. All replaced parts, modules and products become the property of Tektronix.

In order to obtain service under this warranty, Customer must notify Tektronix of the defect before the expiration of the warranty period and make suitable arrangements for the performance of service. Customer shall be responsible for packaging and shipping the defective product to the service center designated by Tektronix, shipping charges prepaid, and with a copy of customer proof of purchase. Tektronix shall pay for the return of the product to Customer if the shipment is to a location within the country in which the Tektronix service center is located. Customer shall be responsible for paying all shipping charges, duties, taxes, and any other charges for products returned to any other locations.

This warranty shall not apply to any defect, failure or damage caused by improper use or improper or inadequate maintenance and care. Tektronix shall not be obligated to furnish service under this warranty a) to repair damage resulting from attempts by personnel other than Tektronix representatives to install, repair or service the product; b) to repair damage resulting from improper use or connection to incompatible equipment; c) to repair any damage or malfunction caused by the use of non-Tektronix supplies; or d) to service a product that has been modified or integrated with other products when the effect of such modification or integration increases the time or difficulty of servicing the product.

THIS WARRANTY IS GIVEN BY TEKTRONIX WITH RESPECT TO THE PRODUCT IN LIEU OF ANY OTHER WARRANTIES, EXPRESS OR IMPLIED. TEKTRONIX AND ITS VENDORS DISCLAIM ANY IMPLIED WARRANTIES OF MERCHANTABILITY OR FITNESS FOR A PARTICULAR PURPOSE. TEKTRONIX' RESPONSIBILITY TO REPAIR OR REPLACE DEFECTIVE PRODUCTS IS THE SOLE AND EXCLUSIVE REMEDY PROVIDED TO THE CUSTOMER FOR BREACH OF THIS WARRANTY. TEKTRONIX AND ITS VENDORS WILL NOT BE LIABLE FOR ANY INDIRECT, SPECIAL, INCIDENTAL, OR CONSEQUENTIAL DAMAGES IRRESPECTIVE OF WHETHER TEKTRONIX OR THE VENDOR HAS ADVANCE NOTICE OF THE POSSIBILITY OF SUCH DAMAGES.

[W16 – 15AUG04]

Table of Contents

General safety summary	v
Service safety summary	1
Preface	3
Manual contents.....	3
Manual conventions	3
Finding other information.....	4
Introduction	5
Strategy for servicing.....	5
Tektronix service offerings	6
Performance verification procedures	6
Operating basics	7
General features.....	7
Installation.....	8
Power the instrument on and off	9
Perform instrument self test and self calibration	10
Protect your instrument from misuse	11
Floating ground	13
Protect your DUT	14
Front panel overview.....	15
Parts of the screen interface	16
Rear panel	17
Theory of operation	19
Overview	19
Main board	20
Front Panel board	21
Power Supply module	21
BNC Insulator boards	21
Adjustment procedures.....	23
Purpose of adjustments.....	23
Equipment required.....	24
Performance conditions	25
Enable the Service mode.....	25
Save/Recall menu.....	25
Clear CAL Data menu.....	25
Reference clock	26
Flatness adjustment.....	27
Resetting the serial number.....	30
Resetting the MAC address.....	30

Maintenance.....	31
Service preparation	31
Preventing ESD	31
Preventive maintenance	32
Inspection and cleaning	33
Removal and installation procedures	37
After repair adjustments.....	38
Before disassembly	38
Equipment required for disassembly	38
Handle removal/installation	39
Case removal/installation	40
Front panel knob removal/installation.....	41
Front panel cover removal/installation	42
LCD display and Front Panel board removal/installation	44
Front BNC Insulator board removal/installation	47
Front chassis and main chassis separation	48
Power Supply module removal/installation.....	51
Fan removal/installation	53
AC line filter removal/installation	56
Main board removal/installation	57
Troubleshooting.....	61
Troubleshooting tools and equipment	61
Troubleshooting tree.....	61
Diagnostics	63
Diagrams	67
Replaceable parts	69
Parts ordering information	69
Using the replaceable parts list.....	70

List of Figures

Figure 1: Instrument dimensions	8
Figure 2: Fuse and fuse adapter.....	12
Figure 3: AFG2021 block diagram.....	19
Figure 4: Frequency/Period tests	26
Figure 5: Flatness adjustment connections	27
Figure 6: Positioning the handle for removal	39
Figure 7: Location of the case retaining screws.....	40
Figure 8: Removing the rear case.....	41
Figure 9: Location of the knob retaining clip	41
Figure 10: Location of the front panel cover retaining screws	42
Figure 11: Removing the front panel cover and rubber keypad.....	43
Figure 12: Disconnecting the front-panel ribbon cable from the Main board	44
Figure 13: Removing the Front Panel board	45
Figure 14: Disconnecting the LCD display cable.....	46
Figure 15: Disconnecting the ribbon cable from the Main board	48
Figure 16: Location of the front chassis retaining screws	49
Figure 17: Correct position of the EMI clip for the USB port.....	50
Figure 18: Correct orientation of BNC insulator.....	50
Figure 19: Correct orientation of power button	50
Figure 20: Location of the Power Supply module cables and retaining screws	51
Figure 21: Positioning the power supply shield on the stand-off posts.....	52
Figure 22: Location of the fan cable	53
Figure 23: Location to start removing the rear panel label	54
Figure 24: Peeling off the rear panel label.....	54
Figure 25: Aligning the rear panel label (Option GL shown)	55
Figure 26: AC line filter cable connections.....	56
Figure 27: Location of Main board retaining screws and stand-offs.....	58
Figure 28: Installing the rear BNC washers, nuts, and insulators	59
Figure 29: Troubleshooting tree	62
Figure 30: Interconnections for the AFG2021	67
Figure 31: Front panel assembly exploded diagram.....	72
Figure 32: Chassis assembly exploded diagram	75

List of Tables

Table 1: Test equipment	24
Table 2: External inspection check list.....	33
Table 3: Internal inspection check list.....	35
Table 4: Troubleshooting equipment	61
Table 5: Error codes.....	65
Table 6: Parts list column descriptions.....	70
Table 7: Front panel assembly replaceable parts (See Figure 31.)	71
Table 8: Chassis assembly replaceable parts (See Figure 32.).....	73

General safety summary

Review the following safety precautions to avoid injury and prevent damage to this product or any products connected to it.

To avoid potential hazards, use this product only as specified.

Only qualified personnel should perform service procedures.

To avoid fire or personal injury

Use proper power cord. Use only the power cord specified for this product and certified for the country of use.

Ground the product. This product is grounded through the grounding conductor of the power cord. To avoid electric shock, the grounding conductor must be connected to earth ground. Before making connections to the input or output terminals of the product, ensure that the product is properly grounded.

Observe all terminal ratings. To avoid fire or shock hazard, observe all ratings and markings on the product. Consult the product manual for further ratings information before making connections to the product.

Do not apply a potential to any terminal, including the common terminal, that exceeds the maximum rating of that terminal.

Power disconnect. The power cord disconnects the product from the power source. Do not block the power cord; it must remain accessible to the user at all times.

Do not operate without covers. Do not operate this product with covers or panels removed.

Do not operate with suspected failures. If you suspect that there is damage to this product, have it inspected by qualified service personnel.

Avoid exposed circuitry. Do not touch exposed connections and components when power is present.

Do not operate in wet/damp conditions.

Do not operate in an explosive atmosphere.

Keep product surfaces clean and dry.

Provide proper ventilation. Refer to the manual's installation instructions for details on installing the product so it has proper ventilation.

Terms in this manual These terms may appear in this manual:



WARNING. *Warning statements identify conditions or practices that could result in injury or loss of life.*



CAUTION. *Caution statements identify conditions or practices that could result in damage to this product or other property.*

Symbols and terms on the product

These terms may appear on the product:

- DANGER indicates an injury hazard immediately accessible as you read the marking.
- WARNING indicates an injury hazard not immediately accessible as you read the marking.
- CAUTION indicates a hazard to property including the product.

The following symbol(s) may appear on the product:

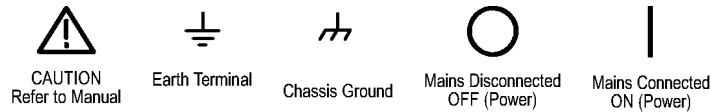

Service safety summary

Only qualified personnel should perform service procedures. Read this *Service Safety Summary* and the *General Safety Summary* before performing any service procedures.

Do not service alone.. Do not perform internal service or adjustments of this product unless another person capable of rendering first aid and resuscitation is present.

Disconnect power. To avoid electric shock, disconnect the mains power by means of the power cord or, if provided, the power switch.

Use care when servicing with power on. Dangerous voltages or currents may exist in this product. Disconnect power, remove battery (if applicable), and disconnect test leads before removing protective panels, soldering, or replacing components.

To avoid electric shock, do not touch exposed connections.

Preface

This manual provides instructions to calibrate, troubleshoot, and repair the AFG2021 Arbitrary Function Generator to the module level.

Manual contents

The manual consists of the following sections:

- *Operating Information* includes general information and operating instructions.
- *Theory of Operation* contains circuit descriptions that support service to the module level.
- *Adjustment Procedures* contains information that you need to manually adjust the *Arbitrary Function generator* so that it meets specifications.
- *Maintenance* contains information and procedures for performing preventive and corrective maintenance of the *Arbitrary Function generator*. These instructions include cleaning, module removal and installation, and fault isolation to the module.
- *Diagrams* contains interconnection diagrams.
- *Replaceable Parts List* includes a table of all replaceable modules, their descriptions, and their Tektronix part numbers.

Manual conventions

This manual uses certain conventions that you should become familiar with.

Some sections of the manual contain procedures for you to perform. To keep those instructions clear and consistent, this manual uses the following conventions:

- Front-panel controls and menu names appear in the same case (initial capitals, all uppercase, and so on) in the manual as is used on the arbitrary function generator front-panel and menus. Front-panel labels are all upper case letters (for example, MENU, SELECT, PULSE GEN, and so on).
- Instruction steps are numbered unless there is only one step.

Modules

Throughout this manual, any replaceable component, assembly, or part of the arbitrary function generator is referred to generically as a module. In general, a module is an assembly (like a circuit board), rather than a component (like a resistor or an integrated circuit). Sometimes a single component is a module; for example, the chassis of the arbitrary function generator is a module.

Safety Symbols and terms related to safety appear in the Safety Summary near the beginning of this manual.

Finding other information

See the following list for other documents supporting the arbitrary function generator. All documents except the Online Help and the Declassification and Security Instructions are located on the *AFG2021 Documentation CD-ROM* that shipped with your instrument. Product documents can also be found on the Tektronix Web site (www.tektronix.com/downloads).

Document name	Description
<i>AFG2021 Quick Start User Manual</i>	A quick reference to major features of the instrument and how they operate. It also provides several tutorials to familiarize you with basic instrument features.
<i>AFG2021 Specifications and Performance Verification Technical Reference</i>	A source for complete instrument specifications and a procedure for verifying the performance of the instrument.
<i>AFG2021 Programmer Manual</i>	An encyclopedia of topics that describe the <i>arbitrary function generator</i> interface and features, and gives background information on how to use them. It provides Menu Structures, User Interface, and Programming Information.
<i>AFG2021 Online Help</i>	An online help system, integrated with the User Interface application that ships with this product. The online help is preinstalled in the instrument.
<i>AFG2021 Declassification and Security Instructions</i>	A source for instructions on how to declassify the instrument.

Introduction

This manual contains information that is needed to properly service the AFG2021 Arbitrary Function Generator as well as general information that is critical to safe and effective servicing.

To prevent personal injury or damage to the arbitrary function generator, consider the following before attempting service:

- The procedures in this manual should be performed only by a qualified service person.
- Read the *General safety summary* and the *Service safety summary*. (See page v.)
- Read the operating requirements for the instrument. (See page 8, *Installation*.)

When using this manual for servicing, be sure to follow all of the warnings, cautions, and notes.

Strategy for servicing

This manual contains the information needed for periodic maintenance of the arbitrary function generator. Further, it contains information for corrective maintenance down to the module level:

- To isolate a failure to a module, use the troubleshooting procedures found in the *Maintenance* section.
- To remove and replace any failed module, follow the instructions in the *Removal and Installation Procedures* subsection.
- After isolating a faulty module, replace it with a fully-tested module obtained from the factory. The *Replaceable Parts List* section contains part number and ordering information for all replaceable modules.

Tektronix service offerings

Tektronix provides service to cover repair under warranty as well as other services that may provide a cost-effective answer to your service needs.

Tektronix service technicians are well trained to service the arbitrary function generator. They have access to the latest information on improvements to the AFG2021 generator as well as new options.

Warranty repair service

Tektronix warrants this product for three years from date of purchase. The warranty appears at the front of this manual. Tektronix technicians provide warranty service at most Tektronix service locations.

Self service

Tektronix supports repair to the replaceable part and module level.

For more information

Contact your local Tektronix service center or sales engineer for more information on any repair or adjustment service.

Performance verification procedures

The performance check is provided in the *AFG2021 Specifications and Performance Verification Technical Reference* manual should be performed every 12 months. In addition, a performance check is recommended after module replacement.

If the AFG2021 does not meet the performance criteria, repair is necessary.

Operating basics

This section provides installation and operating information that is necessary for service.

General features

The AFG2021 Arbitrary/Function Generator offers the functionality of three generators in one:

- 20 MHz Function Generator
- 10 MHz Pulse Generator
- 14 bits Arbitrary Waveform Generator

The following table describes some of the general features of your instrument.

Feature	Description
Channel	1
Sine	20 MHz
Pulse	10 MHz
Memory	128K 14bit
Sampling Rate	250 MS/s
Amplitude	10 Vp-p
Display	Color TFT LCD
Interface	USB GPIB (AFG2021with option GL only) LAN (AFG2021with option GL only)
Synchronous operation	Available
Ground isolation	Available
Context-sensitive Help system	Instrument help available in multiple languages
ArbExpress® Software	Waveform creation and editing tool software

Installation

Use the following information to safely install your instrument.

Operating requirements

The following information and figure describe temperature, clearance, and power supply operating requirements of the instrument.

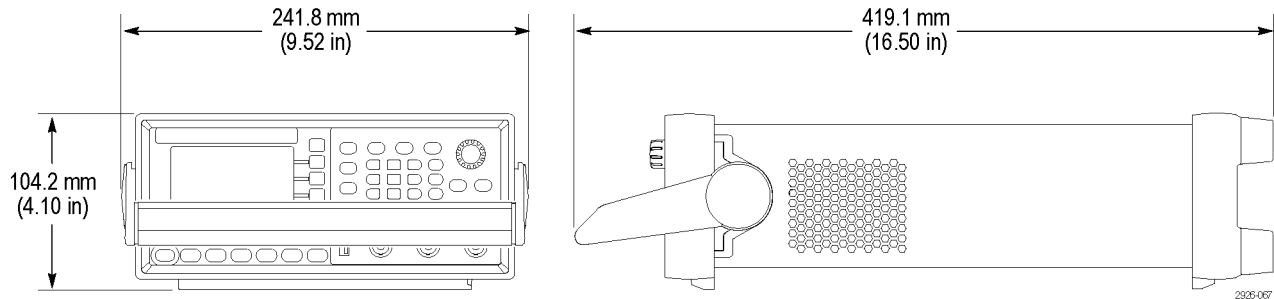

Figure 1: Instrument dimensions

Environmental requirements

Clearance. When placing the instrument on a cart or bench, observing the following clearance requirements:

- Sides: 50 mm (2 in)
- Rear: 50 mm (2 in)

Temperature. Before operating the instrument, ensure the ambient temperature is between 0 °C to +50 °C (+32 °F to +122 °F).



CAUTION. To ensure proper cooling, keep both sides of the instrument clear of obstructions.

Power supply requirements

Source voltage and frequency. 100 V to 240 V, 50 Hz to 60 Hz or 115 V, 400 Hz.

Power Consumption. 60 W



WARNING. To reduce the risk of fire and shock, ensure that the mains supply voltage fluctuations do not exceed 10% of the operating voltage range:

Power the instrument on and off

The following procedures show you how to apply power to the instrument and turn it on and off.



CAUTION. *This product will not function with the rear feet in the down position. Ensure they are raised before instrument setup.*

Power on To turn apply power to the instrument and turn it on, do the following:

1. Insert the AC power cord into the power receptacle on the rear panel and the other end into a properly grounded power outlet.

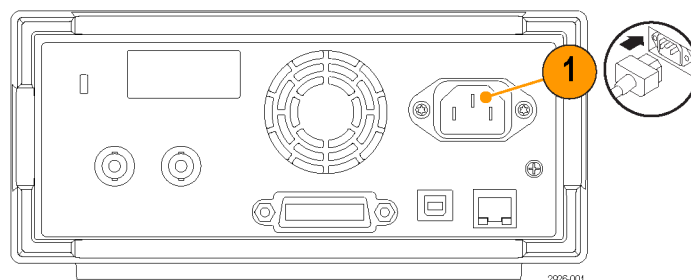

2. Push the front-panel power button to power on the instrument.

NOTE. *Wait until the front panel display shows that the instrument has passed all power-on self tests before using the instrument.*

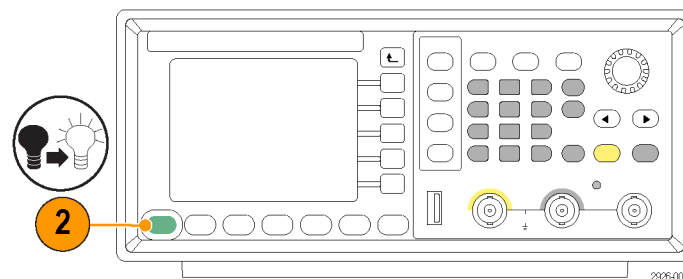

Power off To turn the instrument off, do the following:

1. Push the front-panel power button to power off the instrument.

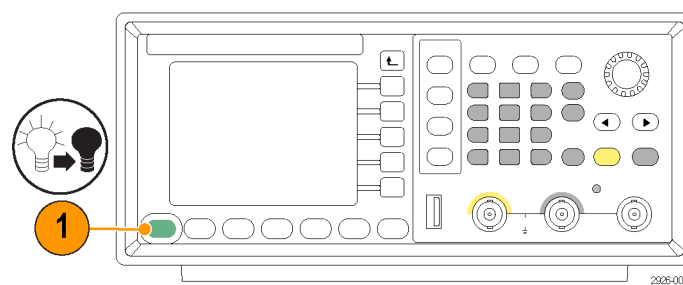

Perform instrument self test and self calibration

The instrument performs a limited set of hardware tests at power-on. You can also perform the following manual diagnostics and/or self calibration using the Utility menu:

NOTE. *Disconnect all the cables from the instrument before performing a self test or a self calibration.*

- **Diagnostics (Self test):** Perform the self test to verify that your instrument is operating correctly.
- **Calibration (Self calibration):** The self calibration mainly checks DC accuracy using the internal calibration routines. Perform at least once a year to maintain DC accuracy. It is recommended that the self calibration should be performed along with a periodic check.

NOTE. *If you need to verify that the instrument meets the warranted specifications, do the complete set of performance verification procedures provided in the Specifications and Performance Verification manual.*



CAUTION. *Do not power off the instrument while executing self calibration. If the power is turned off during self calibration, data stored in the internal memory may be lost.*

1. Push the front-panel Utility button.
2. Push the -more- bezel button.
3. Push the Diagnostics/Calibration bezel button.

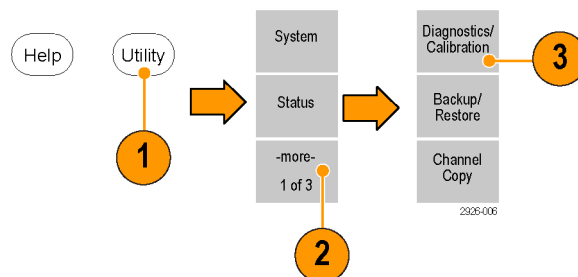

4. Do one of the following:

NOTE. Before executing self calibration, ensure that the ambient temperature is between +20 °C and +30 °C (+68 °F to +86 °F), and allow a 20 minute warm-up period.

Execute Diagnostics:
Push this bezel button to execute the instrument diagnostics.

Execute Calibrations:
Push this bezel button to execute self calibration.

5. If the diagnostics or calibration completes without any errors, the message "PASSED" is displayed.



Protect your instrument from misuse

Check input and output connectors

When connecting a cable, be sure to distinguish the input connector from the output connectors to avoid making the wrong connection.

NOTE. The instrument input and output connectors are floating inputs/outputs. (See page 13, Floating ground.)

1. Locate the Channel Output and the Trigger Output connectors on the front panel.
2. Locate the Trigger Input on the front panel.

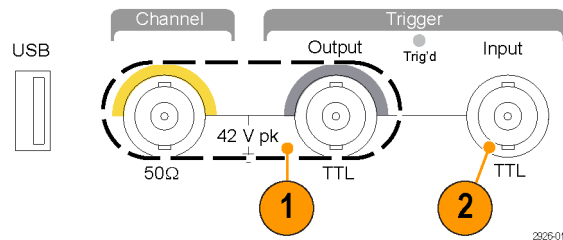

3. Locate the Ext Mod Input and the Ext Ref Input connectors on the rear panel.

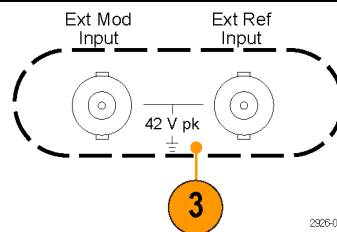

WARNING. To avoid personal injury due to electric shock, do not apply voltages in excess of 42 Vpk to any BNC connector ground or to the chassis ground.



CAUTION. Do not short output pins or apply external voltages to Output connectors. The instrument may be damaged.



CAUTION. Do not apply excessive inputs over +5 V to Trigger Input connector. The instrument may be damaged.

Use fuse adapter

The instrument will be damaged if a large DC or AC voltage is applied to the output or input connectors. To protect the output circuits, a fuse adapter is provided as an optional accessory. When the instrument is used by students or other inexperienced users, always attach the fuse adapter to the output connectors to avoid damage. (See the *AFG2021 User Manual* for information about optional accessories.)

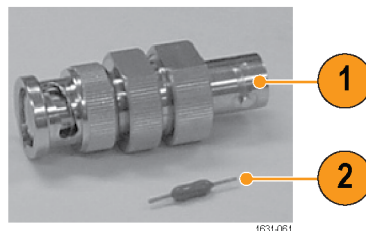

Figure 2: Fuse and fuse adapter

1. Fuse adapter
2. Fuse

Floating ground

Since the common input and output channels of the arbitrary/function generator are electrically isolated from the chassis ground (the instrument chassis and ground line of the AC connector), you can make a floating connection between the instrument and other equipment.

All the BNC connectors are connected to the common ground, and the remote interface connector is connected to the chassis ground.

CAUTION. *The maximum rated voltage between the chassis ground and common ground is 42 V_{p-p} (DC + peak AC). When the potential voltage between the chassis ground and common ground goes over 42 V_{p-p}, the internal protective circuit will be activated to protect the circuits. However, higher voltage may cause the internal circuits in the instrument to be damaged.*

When a potential voltage exists between the chassis ground and common ground, a short circuit from output to ground causes the instrument internal fuse to open and the output is stopped. If the fuse opens, you need to contact your local Tektronix Service Support.

When a potential voltage exists between the common ground and chassis ground, short-circuiting between them may lead to excessive current flow and the internal or external circuits may be damaged.

WARNING. *To prevent electrical shock, use this product so that the sum of the floating voltage and the output voltage of the instrument does not exceed 42 V_{pk}. Do not touch the center of the BNC while the equipment is in use.*

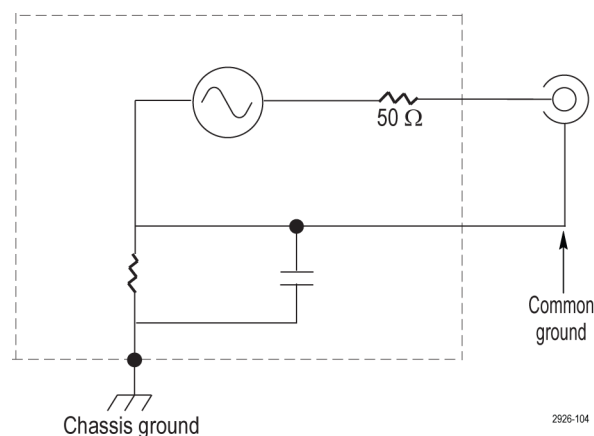

2926-104

Protect your DUT

Use care when you connect the instrument Channel Output to your DUT (device under test). To avoid damage to your DUT, the following preventive measures are provided. Follow these steps to set the limit values for high level and low level.

1. Push the Output Menu bezel button.
2. Push the Limit bezel button.

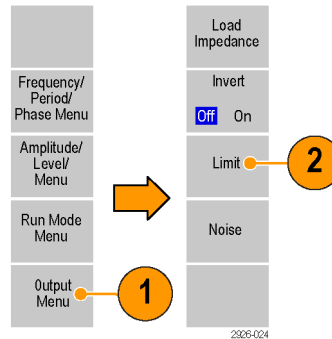

3. Push the High Limit bezel button.
4. Notice that in this example, High Limit is set to 5.000 V, and Low Limit is set to -5.000 V.

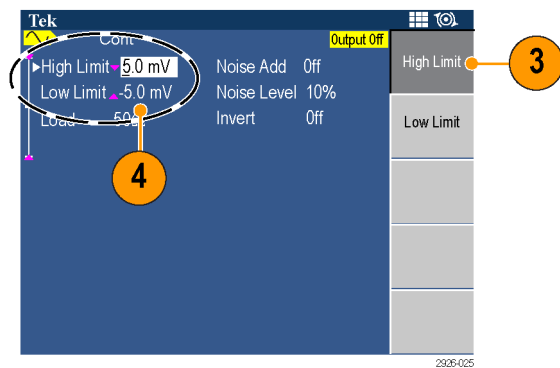

5. Use the numeric keys or the general purpose knob to set the High Limit to 50 mV and the Low Limit to -50 mV.
6. Push the front-panel Sine button to display the waveform parameter. Confirm that High and Low voltage levels were changed.

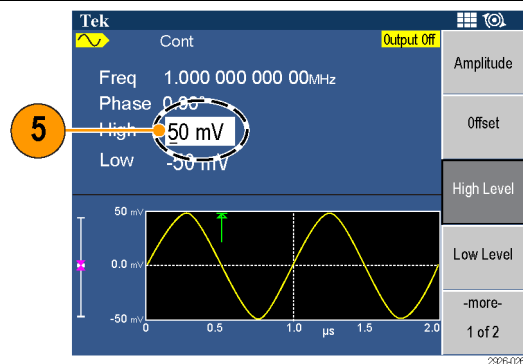

NOTE. You cannot enter any values greater than 50 mV for High level.

NOTE. When you set limit values using the Output Menu, a level indicator is displayed at the left end of the graph area.

Front panel overview

The front panel is divided into easy-to-use functional areas. This section provides you with a quick overview of the front panel controls and the screen interface.

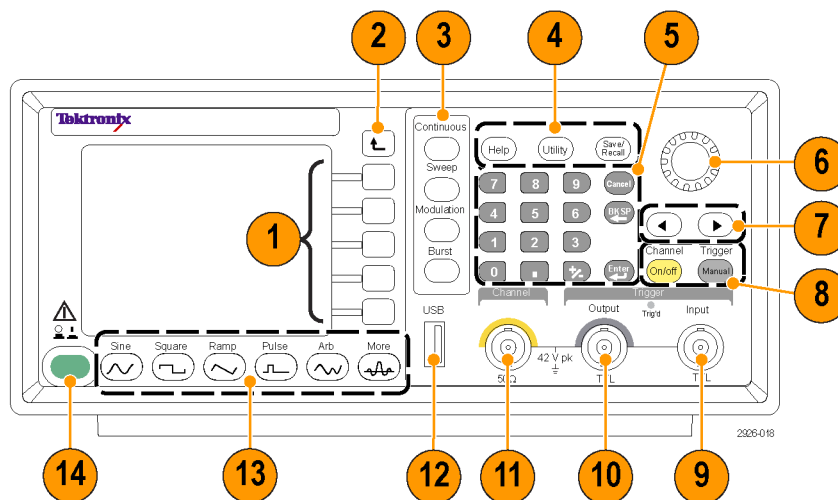

Item	Description
1	Bezel buttons
2	Return to previous menu
3	Run mode buttons
4	Help, Utility, and Save/Recall buttons
5	Numeric keypad, cancel action, delete/backspace, and Enter buttons
6	General purpose knob
7	Arrow buttons allow you to select a specific number on the display screen when you are changing amplitude, phase, frequency, or other such values
8	Channel On/Off and Manual Trigger buttons
9	Trigger input connector
10	Trigger output connector
11	Channel output connector
12	USB connector
13	Function buttons
14	Power button

Lock or unlock the front panel controls

If you need to lock the front panel controls, use the following remote command:

- `SYSTem:KLOCK[:STATe]`

To unlock the front panel without using a remote command, push the front-panel Cancel button twice.

Parts of the screen interface

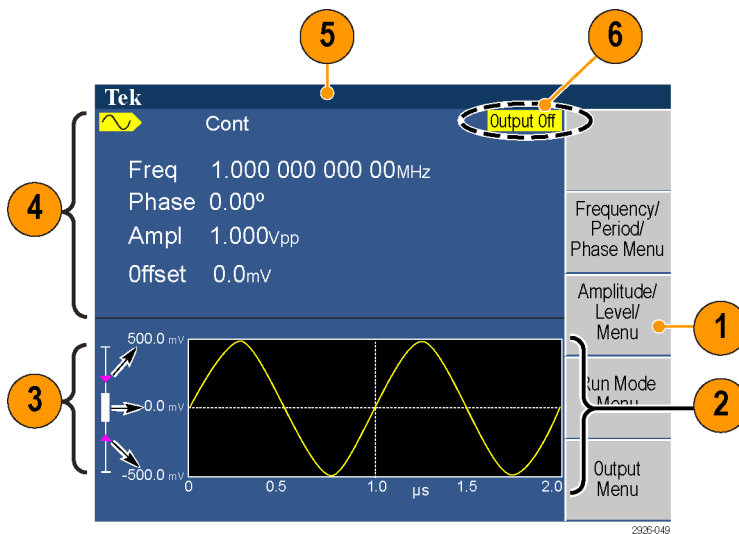

Item	Description
1	Bezel menu: When you push a front panel button, the instrument displays the corresponding menu on the right side of the screen. The menu shows the options that are available when you push the unlabeled bezel buttons directly to the right of the screen. (Some documentation may also refer to the bezel buttons as option buttons, side-menu buttons, or soft keys.)
2	Graph / waveform display area: This part of the main display area shows the signal as a graph or waveform.
3	Level meter: The top portion of the indicator shows the high limit value; the bottom portion of the indicator shows the low limit value; and the indicator itself shows the currently selected level.
4	Parameter display area: This part of the main display area shows active parameters.
5	Message display area: A message that monitors hardware status such as clock or trigger is displayed in this area.
6	Output status: If the output is set to disable, Output Off message is displayed in this area. When you push the front panel channel output button to enable the output, the message will disappear.

Rear panel

The following illustration shows the rear panel connectors for the instrument.

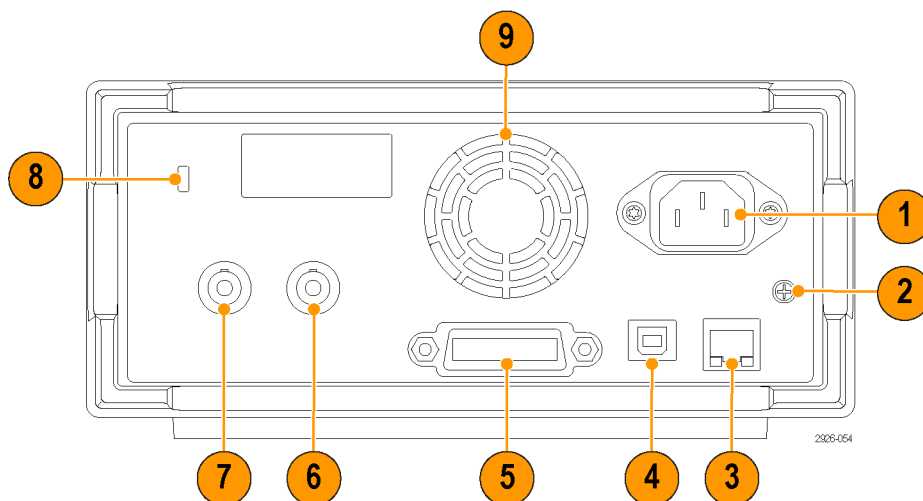

Item	Description
1	Power input: This is where you attached an appropriate power cord to supply power to the instrument.
2	Chassis ground screw: This screw is used to ground the instrument. Use a unified coarse screw (#6-32, 6.35 mm length or less).
3	LAN port: This port can be used to connect the instrument to a network. Connect a 10BASE-T or 100BASE-T cable here. <i>NOTE. This port is only available for the AFG2021 with option GL.</i>
4	USB (type B) connector: This can be used to connect a USB type B controller.
5	GPIB: This is port can be used to control the instrument through GPIB commands. <i>NOTE. This port is only available for the AFG2021 with option GL.</i>
6	EXT REF INPUT connector: This is a BNC connector for the external reference input.
7	EXT MODULATION INPUT connector: This is a BNC connector for the external modulation input. It can be used to input a modulated signals.
8	Security slot: This slot allows you to use a standard laptop computer security cable to secure your instrument to your location.
9	Fan (ventilation) vent: This is the ventilation opening for the fan.

Theory of operation

This section describes the electrical operation of the AFG2021 instrument to the module level. It describes the basic operation of each functional circuit block shown in the block diagram. (See Figure 3 on page 19.)

Overview

AFG2021 instrument provides a basic model with a USB interface and an option GL model which adds GPIB and LAN interfaces.

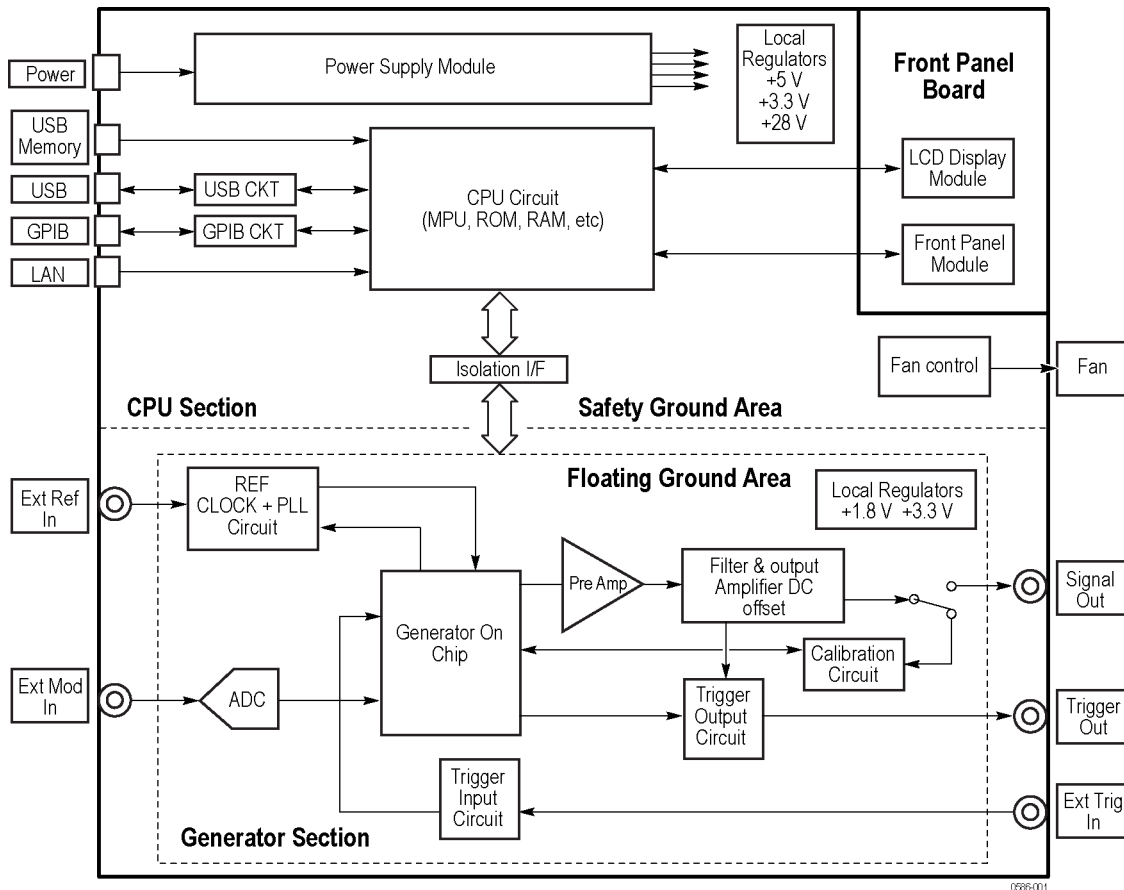

Figure 3: AFG2021 block diagram

Main board

CPU section **CPU circuit.** The CPU Circuit contains an MPU, Flash RAM, and DRAM to control the instrument. The liquid crystal controller and the USB circuit are included in the MPU.

Local regulators. This regulator stabilizes and supplies +3.3 V and +5.0 V for the logic circuit.

Remote interface. This section contains a GPIB and LAN driver circuit.

Fan controller. This circuit controls the speed of the fan.

Primary circuit. Contains the power switch and the filter circuit.

Signal I/O circuit. The Reference Clock Input/Output and the Modulation Input signals are transmitted to the Generator section through this section.

Generator section **Isolator.** Transmit the serial control signal from the CPU section to the following circuits with electrical insulation.

Clock circuit. Generates a 1 GHz high-speed clock necessary for the signal generation from a 10 MHz reference clock by PLL. This circuit has a function of selecting the reference signal source as well.

GoC ASIC. GoC (Generator on Chip) ASIC is a CMOS waveform synthesis IC which includes 2 GS/s DA, Direct Digital Synthesis, waveform SRAM 128 K, x8 MUX, Modulation, Burst and Sweep. So GoC manages most of the generator section.

Trigger circuit. Receives an External Trigger input signal, executes the level conversion, then supplies the level converted trigger signal to the GoC ASIC.

Pre-Amplifier circuit. Converts the differential output signal of the GoC to single ended output, then supplies the single ended output to the Output Amplifier through the Attenuator.

Output amplifier. The output of the pre-amplifier is amplified and output. LPF is used when a sine wave is output.

Trig Out circuit. Sync Out signal from GoC ASIC is level converted to Trigger Out.

ADC. Modulation by an external source is performed by digitally sampling the external input from the Ext Modulation Input connector.

Local regulator. Supplies the necessary +1.8 V, +3.3 V, +15 V, and -15 V power.

On/Off relay. On/Off of the output signal.

Calibration circuit. DC Calibration of the output signal is done by a 16 bit AD Converter.

Fan A 50 mm by 50 mm size, DC 12 V type fan. It is driven by fan controller in the CPU section.

Front Panel board

Front panel module The Front Panel controls a rubber button matrix, LED, a buzzer, and a rotary encoder.

LCD display module The display is a 3.5 inch QVGA (320 x 240) color TFT LCD.

Power Supply module

The power supply module provides +4.3 V, ± 15 V, and +5 V to the circuit. This power supply module accepts the input voltage within the range of 250 VAC from 90 VAC.

BNC Insulator boards

Front BNC Insulator board This board insulates the I/O signals on the front panel BNC connectors from the chassis.

Rear BNC Insulator board This board insulates the I/O signals on the rear panel BNC connectors from the chassis.

Adjustment procedures

This section describes the procedures necessary to manually adjust the AFG2021 Arbitrary Function Generator. Perform each adjustment when you exchange a circuit board.

Purpose of adjustments

This procedure returns the arbitrary function generator to compliance with its Warranted Characteristics as listed in the Specification section. It can also be used to optimize the performance of the arbitrary function generator.

Adjustment interval Generally, these adjustments should be performed every 12 months.

After repair adjustments After the removal and replacement of a module due to electrical failure, perform the following two adjustments as described in this section:

- Reference clock
- Flatness

Equipment required

The following table lists the equipment that is required to complete the adjustment procedures.

Table 1: Test equipment

Description	Minimum requirements	Recommended equipment	Purpose
1. Power meter	100 kHz to 250 MHz 1 μ W to 100 mW (-30 dBm to +20 dBm) Accuracy: 0.02 dB Resolution: 0.01 dB	R&S NRVS	Measures voltage. Used in multiple procedures.
2. Power head	100 kHz to 250 MHz 1 μ W to 100 mW (-30 dBm to +20 dBm)	R&S NRV-Z5	Measures voltage. Used in multiple procedures.
3. Frequency counter	50 kHz to 5 GHz, Accuracy: 0.01ppm Phase measurement	Tektronix FCA3100 or equivalent	Checks clock frequency.
4. BNC coaxial cable (2 required)	50 Ω , male to male BNC connector, 91 cm	Tektronix part number 012-0482-00	Signal interconnection
5. BNC terminator	50 Ω , $\pm 1\Omega$, 2 W, DC to 1 GHz, BNC	Tektronix part number 011-0049-02	Signal termination
6. Adapter dual-banana Plug	BNC (female) to dual banana	Tektronix part number 103-0090-00	Signal interconnection to a DMM

Performance conditions

The adjustments in this section are an extensive, valid confirmation of performance and functionality when the following requirements are met:

- The cabinet covers must be on the instrument.
- The instrument must have been calibrated/adjusted at an ambient temperature between +20 °C and +30 °C.
- The instrument must have had a warm-up period of at least 20 minutes.

Enable the Service mode

You must enable the service mode to perform the adjustment procedure. Do the following steps to enter the service mode:

1. Push the power button to power on the arbitrary function generator.
2. After the beep, push the front-panel **Recall** button, and then push the front-panel **7** numeric button.
3. Keep pushing these buttons until the power-on screen is displayed.
4. Release the buttons when the top screen is displayed.
5. Check whether the service mode is available by pushing the **Utility > -more- > -more-** buttons. The Service Menu selection is displayed in the third page of the Utility menu.

Save/Recall menu

You can adjust the Reference Clock and Flatness parameters on the Manual Calibration that is described in this section. Each of changed parameters is stored in non-volatile memory of the arbitrary function generator after you push the Save menu in the first page of Manual Calibration. Previous adjustment parameters will be recalled after a power cycle unless you push the Save/Recall menu button.

Clear CAL Data menu

The Clear CAL Data menu in the second page of Manual Calibration clears all the current adjustment parameters and sets them to 0. However, unless you push the Save/Recall menu button, the previous adjustment parameters will be recalled after a power cycle.

Reference clock

This procedure adjusts the frequency accuracy of the arbitrary function generator. Only one frequency point of the output channel is adjusted.

1. Connect the arbitrary function generator to the frequency counter as shown in the following figure.

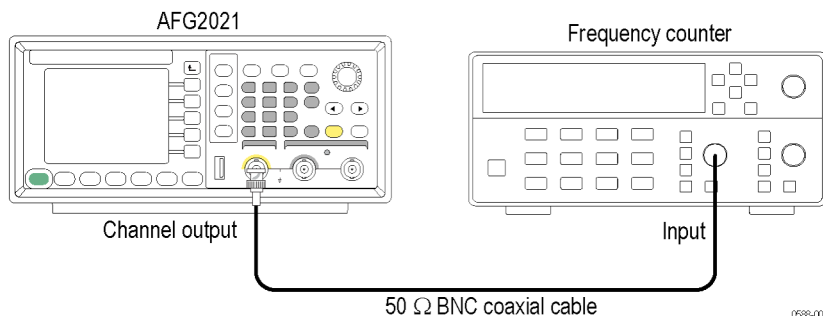



Figure 4: Frequency/Period tests

2. Push the following buttons to recall the arbitrary function generator default setup:

Save/Recall > Setup > Recall > Default.
3. Set up the arbitrary function generator as follows:
 - a. Push the **Sine** button on the front panel
 - b. Push the **Frequency/Period/Phase Menu** bezel button.
 - c. Push the **Frequency** bezel button (it will turn dark when activated) and use the numeric keypad or general purpose knob to set the frequency to 1.000000 MHz.
 - d. Push the  button on the front panel to return to the top menu.
 - e. Push the **Amplitude/Level Menu** bezel button.
 - f. Push the **Amplitude** bezel button (it will turn dark when activated) and use the numeric keypad or general purpose knob to set the amplitude to 1.000 Vp-p.
 - g. Check that the **Channel On/Off** front panel button LED is lit. If it is not lit, then the channel output is off. Push the **Channel On/Off** button to turn it on.
4. Check that reading of the Frequency Counter is between 0.999999 MHz and 1.000001 MHz.
5. Push the **Pulse** button on the front panel.

6. Adjust the Ref Clock value with the front panel rotary knob on the generator so that the frequency counter reading is between 0.999999 MHz and 1.000001 MHz.
7. Push the **Save/Recall** button on the front panel.
8. Push the **Save** bezel button to save the adjusted value.

Flatness adjustment

To obtain the flatness of sine waveform relative to the 100 kHz sine waveform, compensate the output level of the sine waveform at 5 MHz interval with the power meter.

1. Connect the arbitrary function generator to the power meter with a power head as shown in the following figure.

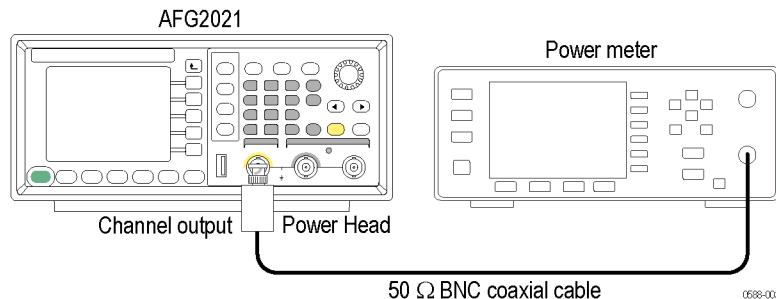



Figure 5: Flatness adjustment connections

2. Set up the arbitrary function generator as follows:
 - a. Push the **Sine** button on the front panel.
 - b. Push the **Frequency/Period/Phase Menu** bezel button.
 - c. Push the **Frequency** bezel button (it will turn dark when activated) and use the numeric keypad or general purpose knob to set the frequency to 100.0000 kHz.
 - d. Push the  button on the front panel to return to the top menu.
 - e. Push the **Amplitude/Level Menu** bezel button.
 - f. Push the **-more-** bezel button.
 - g. Push the **Units** bezel button and then push the **dBm** bezel button to change the voltage units to dBm.
 - h. Push the **-more-** bezel button.

i. Push the **Amplitude** bezel button (it will turn dark when activated) and use the numeric keypad or general purpose knob to set the amplitude to +4.0 dBm.

j. Check that the **Channel On/Off** front panel button LED is lit.

If it is not lit, then the channel output is off. Push the **Channel On/Off** button to turn it on.

3. Set the frequency of the power meter to 100 kHz, and compensate the power meter so that the reading value at 100 kHz may become 0 dB with the frequency dependent offset function. Then set up the power meter to the relative measurement mode.
4. Change the frequency of the power meter setting to 5 MHz so that it is the same as the arbitrary function generator frequency.
5. The power meter shows the value difference from the reference value, which is ± 0.30 . Set this value to the **Flatness** field of the arbitrary function generator.

6. Repeat steps 4 through 5 until the setting of the arbitrary function generator is 20 MHz.

The output signal frequency of the arbitrary function generator increases in 5 MHz steps every time you increase the frequency. Set the frequency of the power meter to the same frequency of the arbitrary function generator in step 4.

Resetting the serial number

When you replace the A72 CPU board, you must set the serial number. Perform the following procedure to set the serial number:

1. Enable the Service mode. (See page 25, *Enable the Service mode.*)
2. Push the **Utility** > **-more-** > **-more-** buttons.
3. Push the **Service Menu** > **Factory Initialize** > **Serial Number** buttons.
4. Enter the serial number using the numeric keys and Function buttons.

NOTE. Use the Function buttons to enter alphabetical characters. The *Sine to More...* button corresponds to A through F.

5. Push the **OK** button.

Resetting the MAC address

The MAC Address is set at the factory and usually does not need to be reset. When a new MAC address setup is required, perform the following procedure:

1. Enable the Service mode. (See page 25, *Enable the Service mode.*)
2. Push the **Utility** > **-more-** > **-more-** buttons.
3. Push the **Service Menu** > **Factory Initialize** > **MAC Address** buttons.
4. Enter the MAC address using the numeric keys and Function buttons.

NOTE. Use the Function buttons to enter alphabetical characters. The *Sine to More...* button corresponds to A through F. Use the +/- key to enter hyphens.

5. Push the **OK** button.

Maintenance

This section contains the information needed to do periodic and corrective maintenance on the arbitrary function generator. The following subsections are included:

- *Preparation* – Tells you how to get ready to do arbitrary function generator maintenance.
- *Preventing ESD* – Provides general information on preventing damage to internal modules when doing maintenance.
- *Inspection and Cleaning* – Information and procedures for inspecting the arbitrary function generator and cleaning its external and internal modules.
- *Removal and Installation Procedures* – Procedures for the removal of defective modules and replacement of new or repaired modules.
- *Troubleshooting* – Information for isolating failed modules. Included are instructions for operating the internal diagnostic routines of the arbitrary function generator and troubleshooting trees.

Service preparation

Only qualified persons should perform service procedures. Before performing any service procedures, read the *General Safety Summary* and *Service Safety Summary* sections of this manual and the preventing ESD information below.

Refer to the *Operating Information* section and your arbitrary function generator user manual for information about using the arbitrary function generator.

Preventing ESD

When performing any service that requires internal access to the arbitrary function generator, adhere to the precautions on page 6-2. These precautions will help you avoid damaging internal modules and their components due to electrostatic discharge (ESD).



CAUTION. *Static discharge can damage any semiconductor component in this arbitrary function generator.*

- Minimize handling of static-sensitive modules.
- Transport and store static-sensitive modules in their static protected containers or on a metal rail. Label any package that contains static-sensitive modules.

- Discharge the static voltage from your body by wearing a grounded antistatic wrist strap while handling these modules. Service static-sensitive modules only at a static-free work station.
- Do not allow anything capable of generating or holding a static charge on the work station surface.
- Handle circuit boards by the edges when possible.
- Do not slide the modules over any surface.
- Avoid handling modules in areas that have a floor or work-surface covering that is capable of generating a static charge.

Preventive maintenance

Preventive maintenance consists of visually inspecting and cleaning the arbitrary function generator, and using general care when operating it. Perform preventive maintenance more often if you operate the arbitrary function generator in a severe environment. A good time to perform preventive maintenance is just before adjustment of the arbitrary function generator.

General care

For optimum performance, follow these recommendations:

- Protect the arbitrary function generator from adverse weather conditions. The arbitrary function generator is not waterproof.
- Do not store or leave the arbitrary function generator whether the liquid crystal display (LCD) will be exposed to direct sunlight or high humidity for long periods of time.
- The front and rear cases help keep dust out of the arbitrary function generator and must be in place during normal operation.
- To avoid damage to the arbitrary function generator, do not expose them to any sprays, liquids, or solvents.

Inspection and cleaning

This section describes how to inspect for dirt and damage, and how to clean the exterior and interior of the arbitrary function generator. Inspection and cleaning are done as preventive maintenance. Preventive maintenance, when done regularly, may prevent malfunctions and enhance reliability. (See page 32, *Preventive maintenance*.)

The collection of dirt on internal components can cause them to overheat and fail. Dirt also provides an electrical conduction path that could cause an arbitrary function generator failure, especially under high-humidity conditions. Inspect the arbitrary function generator as often as operating conditions require.



CAUTION. *Avoid the use of chemical cleaning agents which might damage the plastics used in this AFG2021 Arbitrary Function Generator. Use only deionized water when cleaning the front panel buttons. Use an ethyl alcohol solution as a cleaner and rinse with deionized water.*

Exterior inspection

Inspect the outside of the arbitrary function generator for damage, wear, and missing parts, using the following check list as a guide. An arbitrary function generator that appears to have been dropped or otherwise abused should be checked thoroughly to verify correct operation and performance. Immediately repair defects that could cause personal injury or cause further damage to the arbitrary function generator.

Table 2: External inspection check list

Item	Inspect for	Repair action
Cabinet, front panel, and cover	Cracks, scratches, deformations, damaged hardware or gaskets.	Repair or replace the defective module.
Front-panel knobs	Missing, damaged, or loose knobs.	Repair or replace missing or defective knobs.
Connectors	Broken shells, cracked insulation, and deformed contacts. Dirt in connectors.	Repair or replace the defective modules. Clear or wash out dirt.
Carrying handle, bail, cabinet feet	Correct operation.	Repair or replace the defective module.

Exterior cleaning

Perform the following steps to clean the exterior of the arbitrary function generator:

1. Remove loose dust on the outside of the arbitrary function generator with a lint-free cloth. Use care to avoid scratching the clear glass display shield.
2. Remove remaining dirt with a lint free cloth dampened in a general purpose detergent-and-water solution. Do not use abrasive cleaners.



CAUTION. *To prevent getting moisture inside the arbitrary function generator during external cleaning, use only enough liquid to dampen the cloth or applicator.*

To avoid damage to the surface of the arbitrary function generator, do not use any abrasive or chemical cleaning agents.

Flat panel display cleaning

The display is a soft plastic display and must be treated with care during cleaning.



CAUTION. *Imported cleaning agents or methods can damage the flat panel display.*

Avoid using abrasive cleaners or commercial cleaners to clean the display surface.

Avoid scrubbing the display with excessive force.

Avoid spraying liquids on the display surface.

1. Clean the flat panel display surface by gently rubbing the display with a clean-room wipe (such as Wypall Medium Duty Wipes, #05701, available from Kimberly-Clark Corporation).
2. If the display is very dirty, moisten the wipe with distilled water or a 75% isopropyl alcohol solution and gently rub the display surface. Avoid using excess force or you may damage the plastic display surface.



CAUTION. *To prevent getting moisture inside the arbitrary function generator during external cleaning, use only enough liquid to dampen the cloth or applicator.*

Interior inspection Inspect and clean the interior if it appears that the arbitrary function generator may have been damaged or exposed to an unusually dirty environment.

To access the inside of the arbitrary function generator for inspection and cleaning, refer to the removal and installation procedures. (See page 37, *Removal and installation procedures*.)

Inspect the internal portions of the AFG2021 Arbitrary Function Generator for damage and wear, using the check list below as a guide. Defects should be repaired immediately.



CAUTION. To prevent damage from electrical arcing, ensure that circuit boards and components are dry before applying power to the arbitrary function generator.

Table 3: Internal inspection check list

Item	Inspect for	Repair action
Front and rear case	Cracks or deformations. Scratched lettering or display filter. Loose connectors or labels.	Repair or replace defective hardware.
Circuit boards	Loose, broken, or corroded solder connections. Burned circuit boards. Burned, broken, or cracked circuit-run plating.	Remove failed module and replace with a new module.
Solder connections	Cold solder or rosin joints.	Resolder joint and clean with ethyl alcohol.
Wiring and cables	Loose plugs or connectors. Burned, broken, or frayed wiring.	Firmly seat connectors. Repair or replace modules with defective wires or cables.
Chassis	Dents, deformations, and damaged hardware.	Straighten, repair, or replace defective hardware.

Interior cleaning Perform the following steps to clean the interior of the instrument:

1. Blow off dust with dry, low-pressure, deionized air (approximately 9 psi).
2. Remove any remaining dust with a lint-free cloth dampened in isopropyl alcohol (75% solution) and rinse with warm deionized water. (A cotton-tipped applicator is useful for cleaning in narrow spaces and on circuit boards.)

NOTE. If these steps do not remove all of the dust or dirt, please contact Tektronix for assistance. (See *Contacting Tektronix at the front of this manual*.)

Lubrication There is no periodic lubrication required for this instrument.

Removal and installation procedures

This section describes how to remove and install the major mechanical and electrical modules. Any electrical or mechanical module, assembly, or part listed in the parts list is referred to as a module.

See the *Replaceable parts* section for a list of all the replaceable modules and diagrams showing their location in the instrument. (See page 69.)



WARNING. *Only qualified personnel should perform service procedures. Before doing this or any other procedure in this manual, read the General Safety Summary and Service Safety Summary found at beginning of this manual.*

Always disconnect the power cord before disassembling any portion of the arbitrary function generator.

To prevent damage to electrical components, follow the instructions for preventing ESD. (See page 31, Preventing ESD.)

The following subsections are included:

- *After repair adjustments* – Describes when to perform the adjustment procedures after a repair.
- *Before disassembly* – Describes what you should do before you disassemble the instrument.
- *Equipment required for disassembly* – Lists the equipment required to remove and install modules.
- *Order of disassembly* – Provides a diagram showing the proper order in which to remove and install modules.
- Removal procedures for each of the replaceable modules.

NOTE. *If you are disassembling the arbitrary function generator for cleaning, refer to the inspection and cleaning instructions. (See page 33, Inspection and cleaning.)*

After repair adjustments

After the removal and replacement of a module due to electrical failure, perform the adjustment procedures. (See page 23, *Adjustment procedures*.)

Before disassembly

Before you disassemble the instrument, do the following:

- Review how to prevent ESD damage. (See page 31, *Preventing ESD*.)
- Review the exploded view diagrams in the *Replaceable parts* section for an overview of how the entire arbitrary function generator is assembled. (See page 69.)
- Review the required equipment list to verify that you have the necessary tools to remove and install modules in the arbitrary function generator. (See page 38, *Equipment required for disassembly*.)

Equipment required for disassembly

Use the following tools to remove and replace all modules:

- Torque-limiting screwdriver, long shank, 8 lb-in (0.85 N m) range with Torx T8 and T15 tips
- 16 mm (5/8 inch) deep socket with wide center hole
- 7 mm (9/32 inch) socket
- Torque wrench to 30 in-lb (3.3 N m)
- Screwdriver with 1/4 inch flat blade
- Phillips head screwdriver
- Pliers (all-purpose and needle-nose)
- Tweezers

Handle removal/installation

Required equipment. None.

Removal. To remove the handle, perform the following steps:

1. Place the arbitrary function generator bottom down on a soft surface such as an antistatic mat.
2. Rotate the handle to the vertical position as shown below.
3. Grasp the handle on one side and pull outward until the handle is clear of the chassis as shown below.
4. Lift the handle clear of the chassis.



Figure 6: Positioning the handle for removal

Installation. To install the handle, perform these steps:

1. Place the arbitrary function generator bottom down on a soft surface such as an antistatic mat.
2. Hook one side of the handle into the hole on the side of the instrument. (See Figure 7.)
3. Grasp the handle on the other side and pull outward until the handle clears the chassis, and then slide the handle down so that the handle fits into the hole in the side of the instrument.

Case removal/installation

Required equipment. You will need a torque-limiting Torx T8 screwdriver to remove and install the case.

Removal. To remove the case, perform the following steps:

1. Place the arbitrary function generator on a soft surface such as an antistatic mat.
2. Remove the rubber boot from the rear panel by pulling it off of the rear of the instrument. Note the orientation of the boot for reinstallation.
3. Use a screwdriver with a Torx T8 bit to remove the four screws located on the bottom of the case.

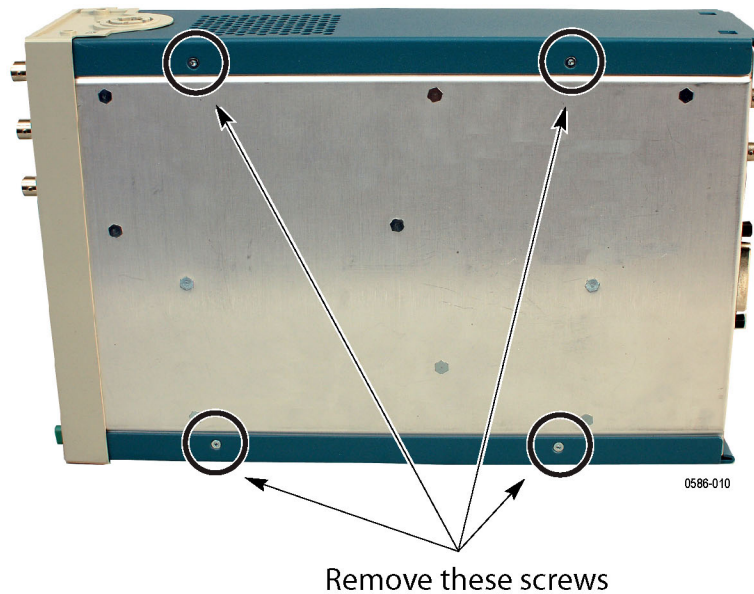

Figure 7: Location of the case retaining screws

- Slide the case off the rear of the arbitrary function generator.

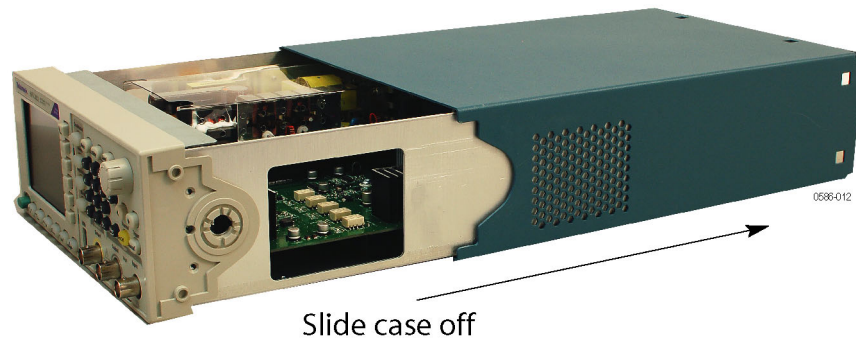

Figure 8: Removing the rear case

Installation. To install the rear case, perform the removal procedure in reverse order. Use the torque-limiting screwdriver to tighten the four retaining screws to 0.49 N m.

Front panel knob removal/installation

Required equipment. None.

Removal. Firmly grasp the knob and pull it away from the shaft.

Installation. Align the keyed knob with the shaft and press the knob onto the shaft.

NOTE. There is a clip located inside the back of the knob to help retain the knob on the shaft as shown below. If the knob is loose or will not stay on the shaft, verify that the clip is properly seated inside the knob and that the clip is not broken.

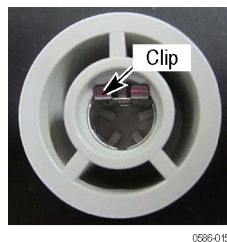

Figure 9: Location of the knob retaining clip

Front panel cover removal/installation

Required equipment. You will need a torque-limiting Torx T8 screwdriver for this procedure.

Removal. To remove the front panel, perform the following steps:

1. Remove the handle from the instrument. (See page 39, *Handle removal/installation*.)
2. Remove the case. (See page 40, *Case removal/installation*.)
3. Remove the front-panel knob. (See page 41, *Front panel knob removal/installation*.)
4. Remove the rubber boot from the front panel by carefully pulling it off of the front of the instrument. Note the orientation of the boot for reinstallation.
5. Remove the four retaining screws (two on each side) that attach the front cover to the chassis.

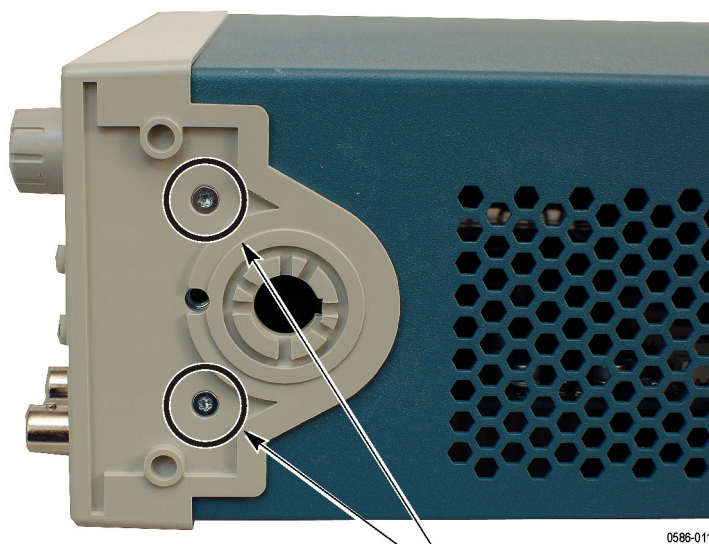

Remove these screws

Figure 10: Location of the front panel cover retaining screws

6. Pull the front cover away from the instrument, taking care not to damage the rubber keypad that attaches to the front cover.

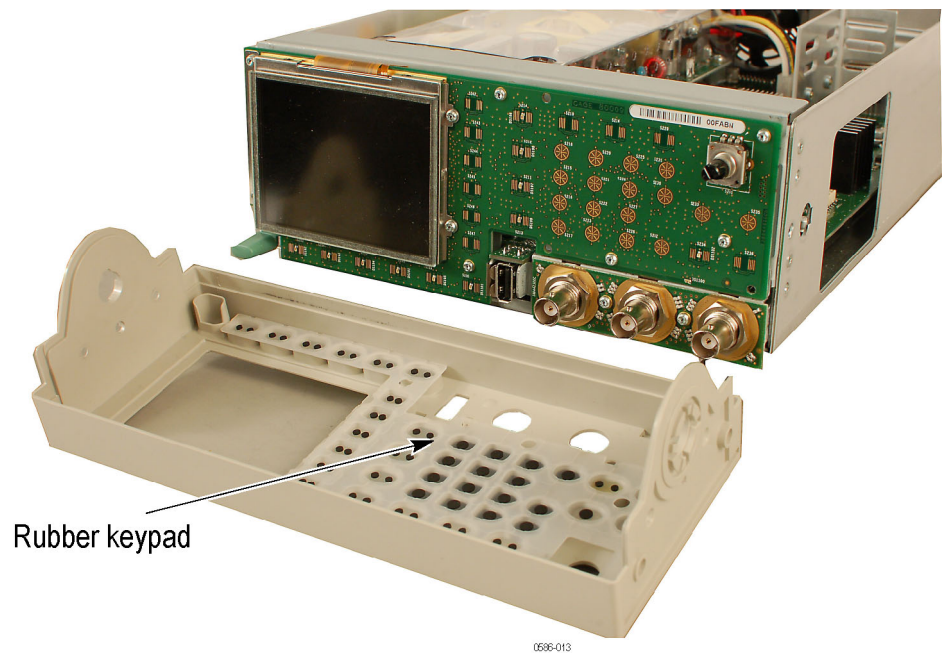

Figure 11: Removing the front panel cover and rubber keypad

Installation. To install the front cover, perform the removal procedure in reverse order. Use the torque-limiting screwdriver to tighten the four front cover retaining screws to 0.49 N m.

LCD display and Front Panel board removal/installation

Required equipment. You will need a torque-limiting Torx T8 screwdriver for this procedure.

Removal. The LCD display is attached to the Front Panel board. To replace the LCD display, you must first remove the Front Panel board from the chassis. To remove the LCD display and the Front Panel board, perform the following steps:

1. Remove the front panel cover. (See page 42, *Front panel cover removal/installation.*)
2. Disconnect the ribbon cable from the Main board by pulling up evenly on both sides of the connector tab to release the cable. (See Figure 12.)



CAUTION. To prevent damage to the cable connector, pull up evenly on both sides of the connector housing. The housing slides up and down to create a compression fit with the cable, and will lift approximately 1 mm to release the cable. You may need to remove the Power Supply board to gain access to the connector.

The ribbon cable connects to the back of the Front Panel board using the same kind of connector. The following figure shows the connector on the back of the board in the raised (unlatched) position.

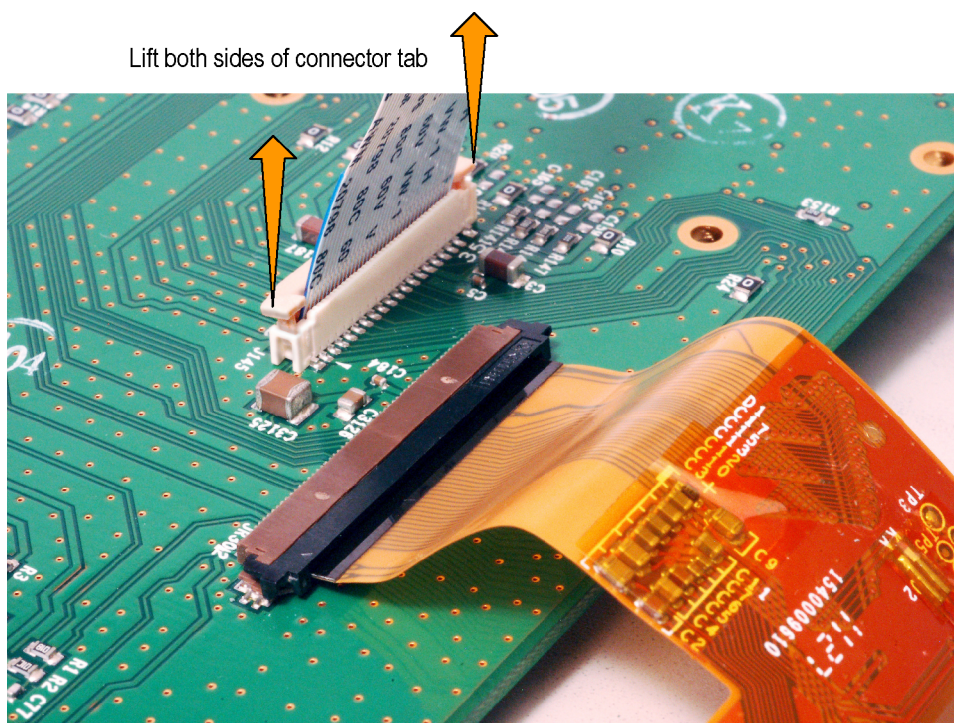

0586-016

Figure 12: Disconnecting the front-panel ribbon cable from the Main board

3. Remove the Front Panel board by first removing the five retaining screws shown below, and then removing the four screws attaching the LCD display to the Front Panel board.



CAUTION. To prevent damage to the LCD display, be careful when you remove the retaining screws holding the LCD display to the Front Panel board. The LCD display will detach from the Front Panel board when the four LCD display retaining screws are removed and will be connected to the board by only the ribbon cable of the LCD display.

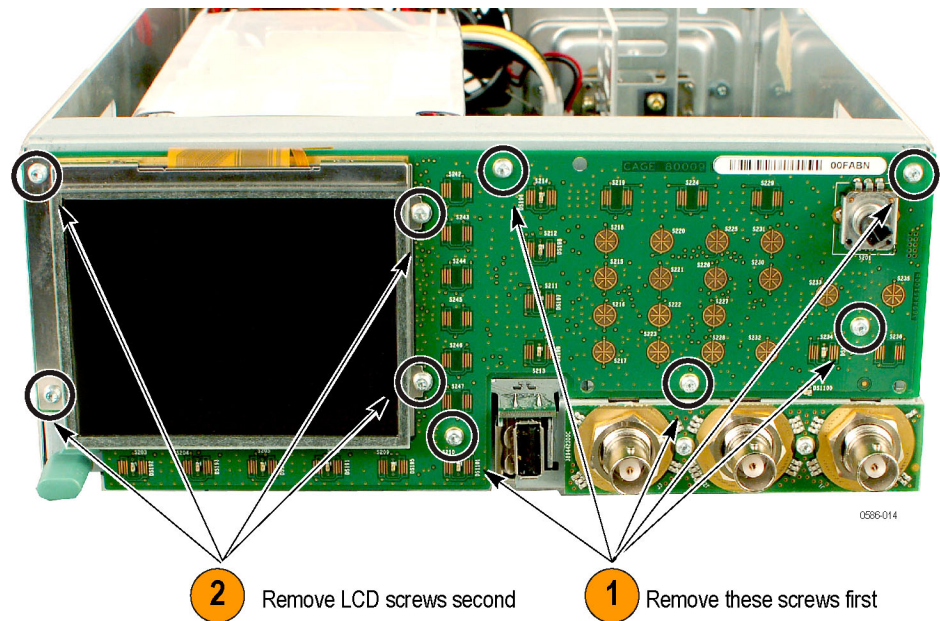
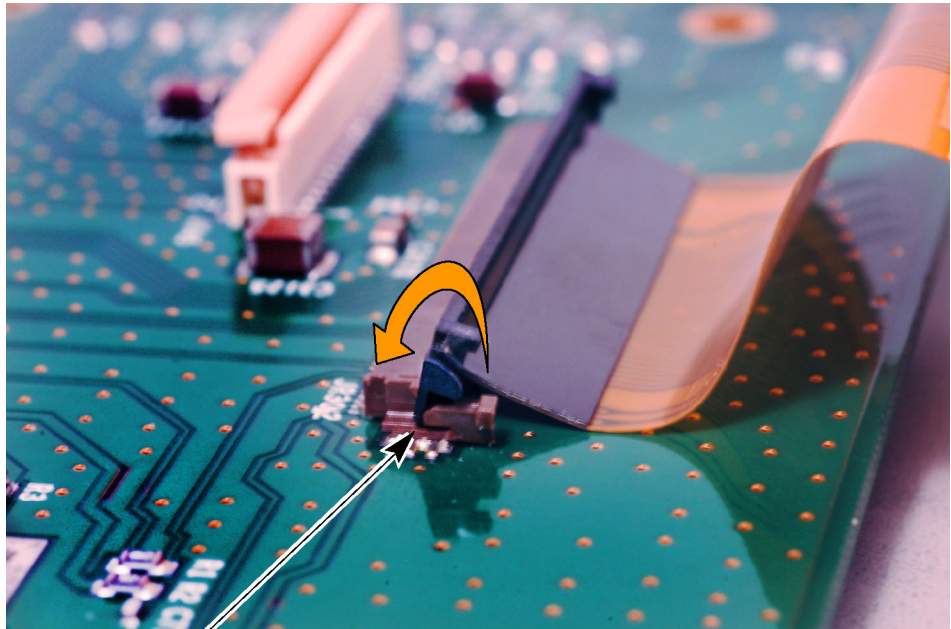

Figure 13: Removing the Front Panel board

4. To remove the LCD display from the Front Panel board, disconnect the ribbon cable from the back of the board.



CAUTION. To prevent damage to the LCD cable connector, pull up evenly on both sides of the connector housing. The housing pivots up and down to create a compression fit with the cable, and will lift approximately 2 mm to release the cable.



Pivot latch up to release

0586-017

Figure 14: Disconnecting the LCD display cable

Installation. To install the Front Panel board, perform the removal procedure in reverse order. Be aware of the following:



CAUTION. To prevent damage to the LCD display cable, carefully roll the cable behind the Front Panel board during assembly. Do not fold or create pressure on the cable.

- Use the torque-limiting screwdriver to tighten each of the retaining screws to 0.49 N m.
- The blue lines on the ribbon cable between the Front Panel board and the Main board will align with the locked connector when the cable has been properly inserted into the connector housing.

Front BNC Insulator board removal/installation

Required equipment. You will need a 16 mm (5/8 inch) deep socket with wide center hole, torque wrench, and torque-limiting Torx T8 screwdriver for this procedure.

Removal. To remove the Front BNC Insulator board, perform the following steps:

1. Remove the front panel cover. (See page 42, *Front panel cover removal/installation*.)
2. Use the torque wrench with a 16 mm (5/8 inch) deep socket with wide center hole to remove the nut and washer from each of the three BNC connectors.
3. Use a screwdriver with Torx T8 tip to remove the two retaining screws on the Front BNC Insulator board.

Installation. To install the Front BNC Insulator board, perform the removal procedure in reverse order. Use the torque-limiting screwdriver to tighten the two board retaining screws to 0.49 N m. Put the BNC washers on before the nuts, and then use the torque wrench to tighten the three BNC nuts to 1.38 N m.

Front chassis and main chassis separation

Required equipment. You will need a 16 mm (5/8 inch) deep socket with wide center hole, torque wrench, and torque-limiting Torx T8 screwdriver for this procedure.

Removal. To remove the front chassis, perform the following steps:

1. Remove the front panel cover. (See page 42, *Front panel cover removal/installation.*)
2. Disconnect the ribbon cable from the Front Panel board from the Main board as shown below.

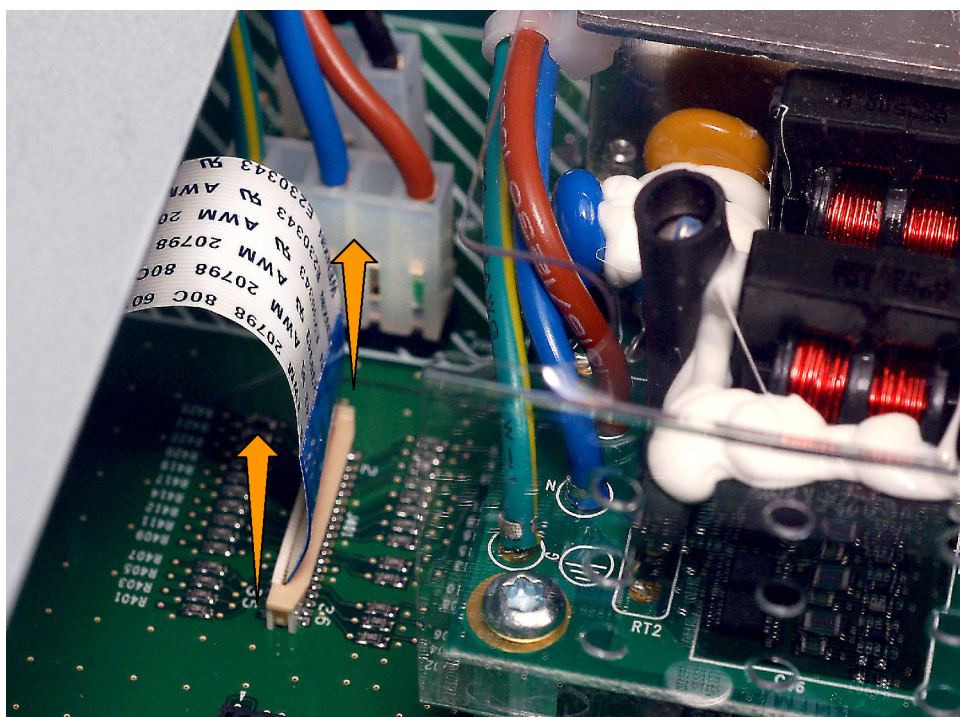

Lift both sides of connector tab

0596-023

Figure 15: Disconnecting the ribbon cable from the Main board

3. Use the torque wrench with a 16 mm (5/8 inch) deep socket with wide center hole to remove the nut and washer from each of the three BNC connectors.
4. Remove the power button by grasping the button and pulling it off of the shaft.

5. Remove the retaining screws on each side of the chassis as shown below.

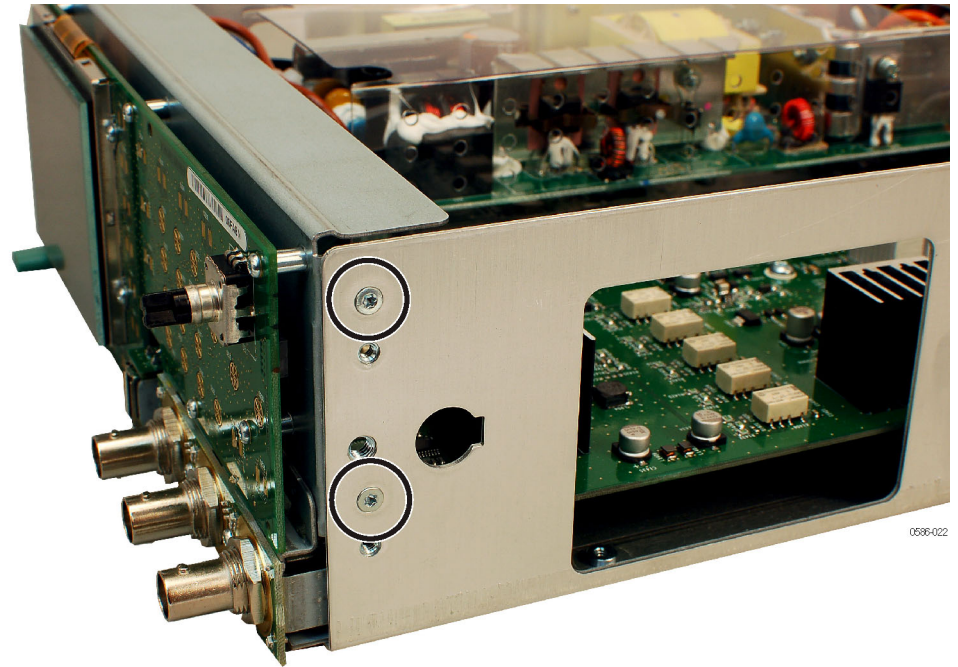

Figure 16: Location of the front chassis retaining screws

6. Gently pull out the front chassis toward the front to remove the front chassis from the main chassis.

Installation. To install the front chassis, perform the removal procedure in reverse order. Be aware of the following:

- Check that the EMI clip for the USB port is correctly installed. (See Figure 17.)
- Correctly orient the plastic BNC insulator on each BNC before you install the front chassis. (See Figure 18.)
- Use the torque-limiting screwdriver to tighten the four front chassis retaining screws to 0.49 N m.
- Put the BNC washers on before the nuts, and then use the torque wrench to tighten the three BNC nuts to 1.38 N m.
- Correctly orient the power button on the shaft. (See Figure 19.)

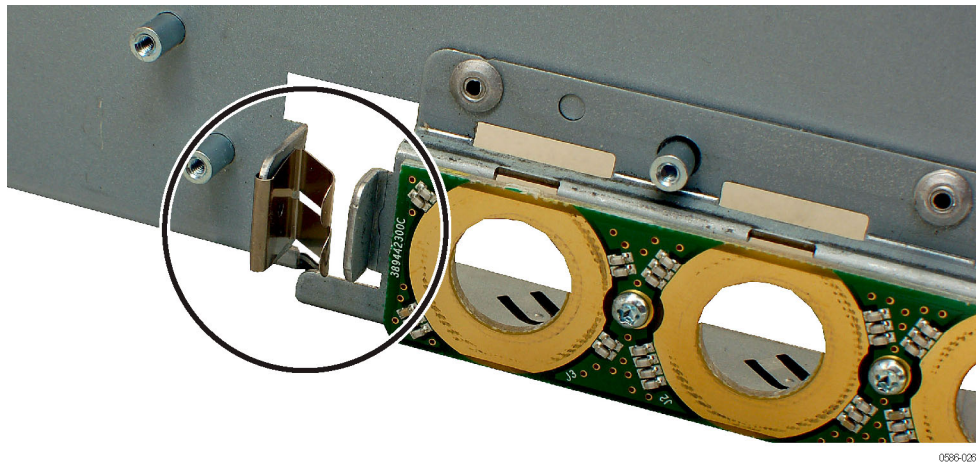

Figure 17: Correct position of the EMI clip for the USB port

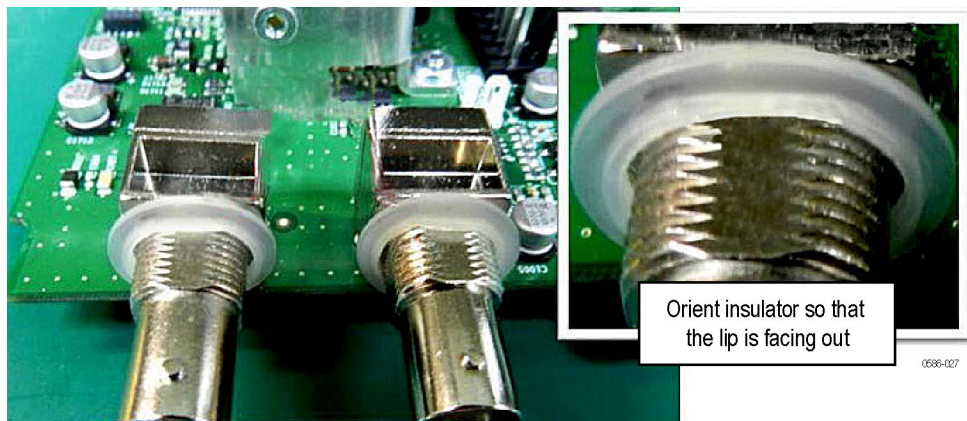

Figure 18: Correct orientation of BNC insulator

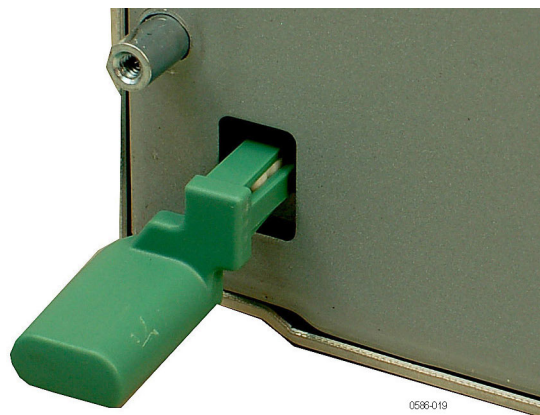

Figure 19: Correct orientation of power button

Power Supply module removal/installation

Required equipment. You will need a torque-limiting Torx T8 and T15 screwdriver for this procedure.

Removal. To remove the Power Supply module, perform the following steps:

1. Remove the case. (See page 40, *Case removal/installation*.)
2. Disconnect the three power supply cables from the Main board (two at the front and two at the rear of the Main board).
3. Remove the four retaining screws from the Power Supply module and lift the module out of the chassis.

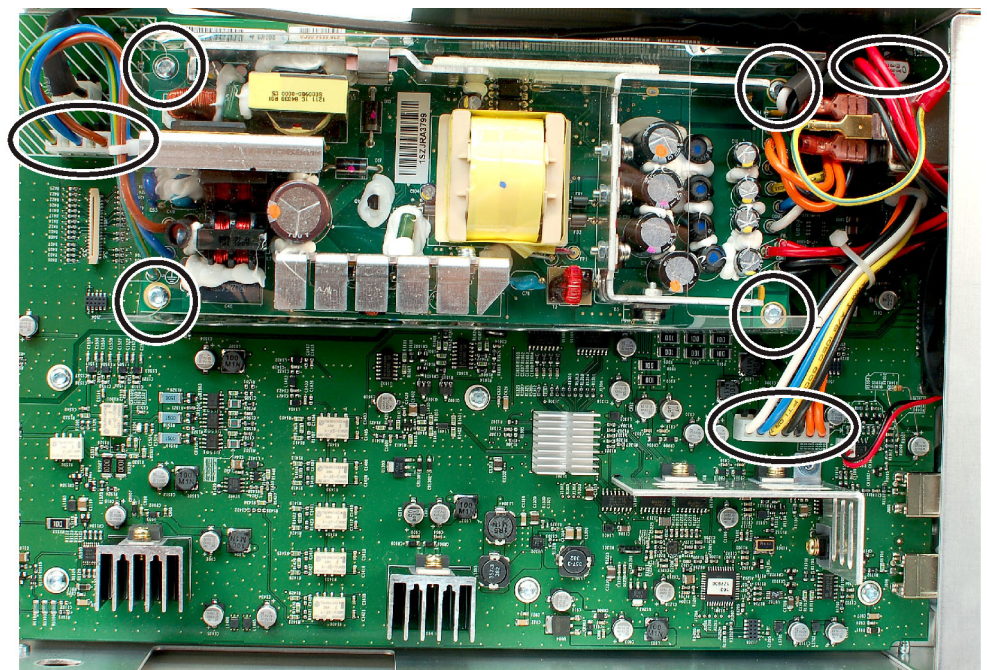

0586-005

Figure 20: Location of the Power Supply module cables and retaining screws

Installation. To install the Power Supply module, perform the removal procedure in reverse order. Be aware of the following:

- Be sure that the holes on the bottom of the power supply shield fit over each of the stand-off posts. (See Figure 21.)
- Tighten the four retaining screws on the Power Supply module to 0.88 N m.

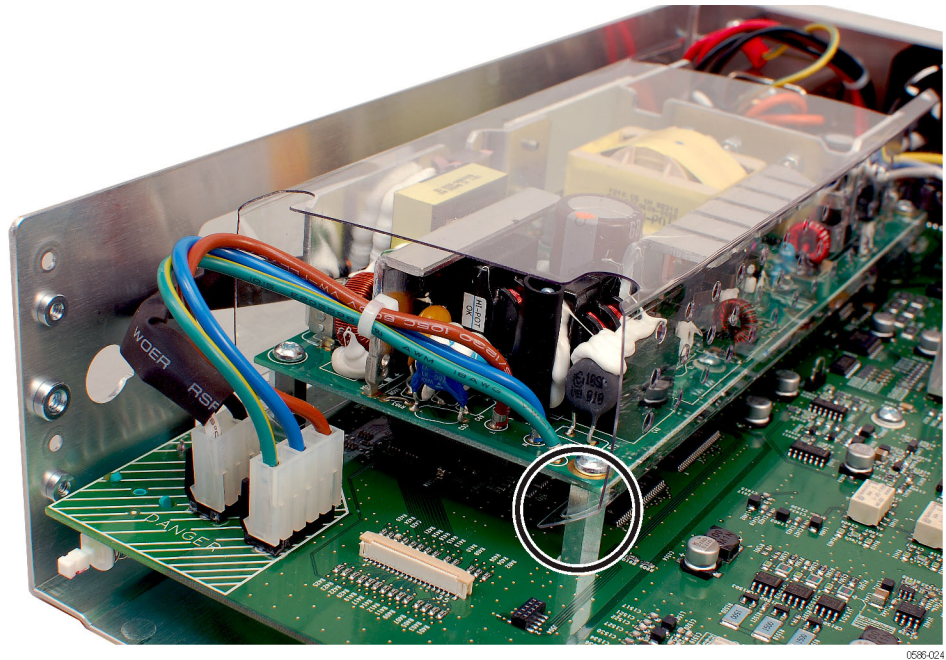

Figure 21: Positioning the power supply shield on the stand-off posts

Fan removal/installation

Required equipment. You will need a torque-limiting Torx T15 screwdriver and tweezers for this procedure.

Removal. To remove the fan from the rear chassis, perform the following steps:

1. Remove the Power Supply module. (See page 51, *Power Supply module removal/installation.*)
2. Disconnect the fan cable from the Main board.

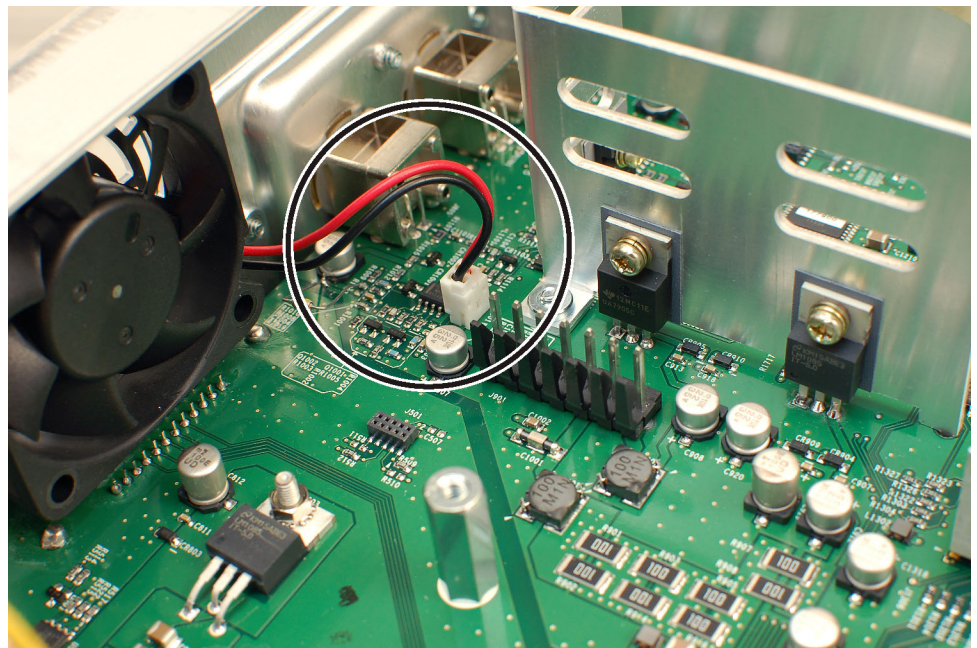

0656-021

Figure 22: Location of the fan cable

3. Check the serial number of the instrument you are servicing. If the number is C010243 or earlier, proceed to step 4. If the number is C010244 or greater, proceed to step 6.
4. Use needle-nose pliers to lift up the edge of the rear panel label at the bottom right corner.



Use screw driver or tweezers to lift label from the rear panel

Figure 23: Location to start removing the rear panel label

5. Slowly peel back the label to minimize the glue residue left on the chassis while removing the label.



After the label is lifted, use thumb and index finger to carefully peel label from rear panel

Figure 24: Peeling off the rear panel label

6. Locate the two fan retaining screws on the rear panel, remove them, and lift the fan out of the chassis.

NOTE. Step 6 only applies to instruments with a serial number of C010244 or greater.

Installation. To install the fan, perform the removal procedure in reverse order. Be aware of the following:

- Tighten the two self-tapping retaining screws for the fan to 1.13 N m.
- When you install the new rear panel label, use the two holes shown below to align the label on the rear panel. (Only applies to instruments with a serial number of C010243 or earlier.)

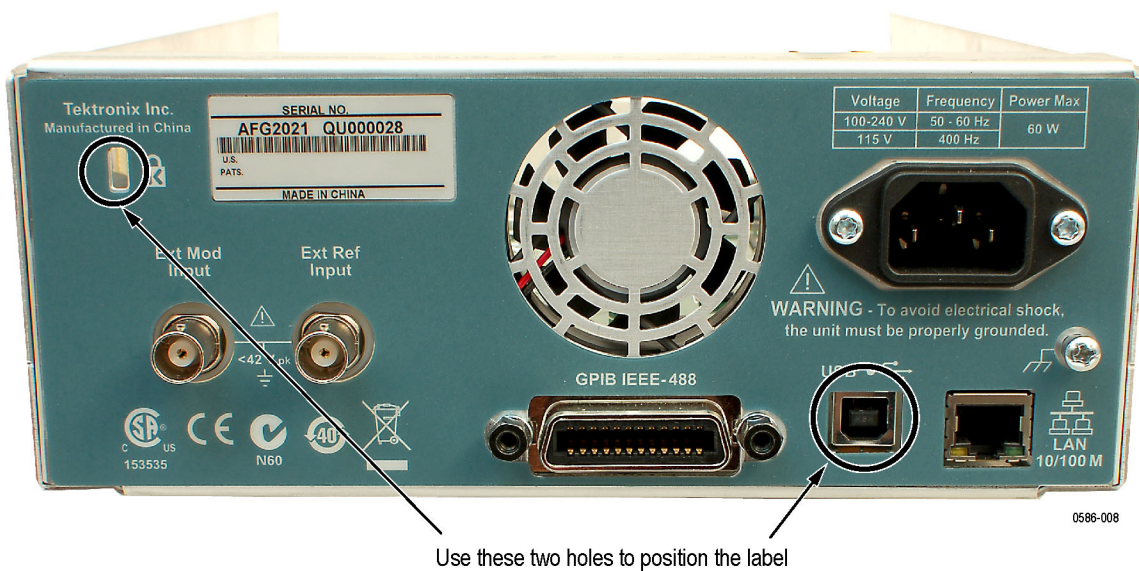

Figure 25: Aligning the rear panel label (Option GL shown)

AC line filter removal/installation

Required equipment. You will need a torque-limiting Torx T15 screwdriver for this procedure.

Removal. To remove the AC line filter, perform the following steps:

1. Remove the Power Supply module. (See page 51, *Power Supply module removal/installation.*)
2. Disconnect the cables from the AC line filter.
3. Remove the two retaining screws attaching the AC line filter to the chassis and pull the filter out from the chassis.

Installation. To install the AC line filter, perform the removal procedure in reverse order. Be aware of the following:

- Tighten the two AC line filter retaining screws for the fan to 0.88 N m.
- If you removed the earth lead to the chassis, tighten the retaining screw to 0.88 N m.
- Reconnect the AC line filter cables as shown below.

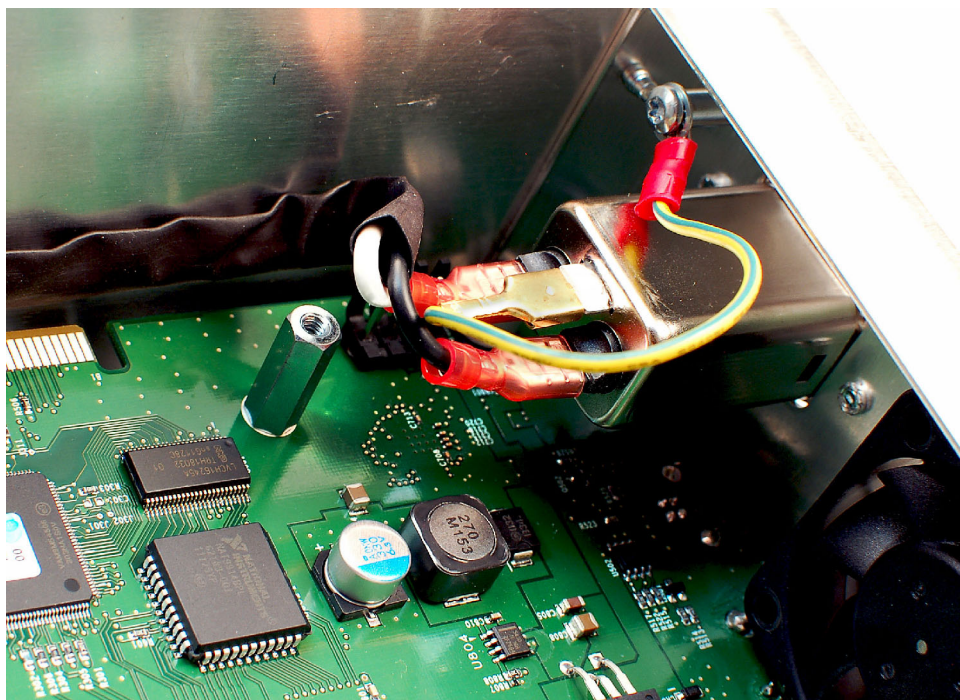

0598-020

Figure 26: AC line filter cable connections

Main board removal/installation

Required equipment. You will need a torque-limiting Torx T8 and T15 screwdriver, a torque wrench, a 16 mm (5/8 inch) deep socket, 7 mm socket, and needle-nose pliers for this procedure.

Removal. To remove the Main board, perform the following steps:

1. Remove the Power Supply module. (See page 56, *AC line filter removal/installation*.)
2. Separate the front chassis and main chassis. (See page 48, *Front chassis and main chassis separation*.)
3. Disconnect the fan cable from the Main board. (See Figure 22 on page 53.)
4. Remove the cable between the Main board and the AC line filter.
5. Use needle-nose pliers to lift up the edge of the rear panel label at the bottom right corner. (See Figure 23 on page 54.)
6. Slowly peel back the label to minimize the glue residue while removing the label. (See Figure 24 on page 54.)
7. **Option GL only:** Remove the two jack screws and washers retaining the GPIB connector.
8. Remove the two screws retaining the BNC cover plate.
9. Remove the BNC insulator from each BNC and then remove the BNC nuts and washers.
10. Remove the two screws retaining the Rear BNC Insulator board.

11. Remove the six screws and four stand-offs retaining the Main board to the chassis.

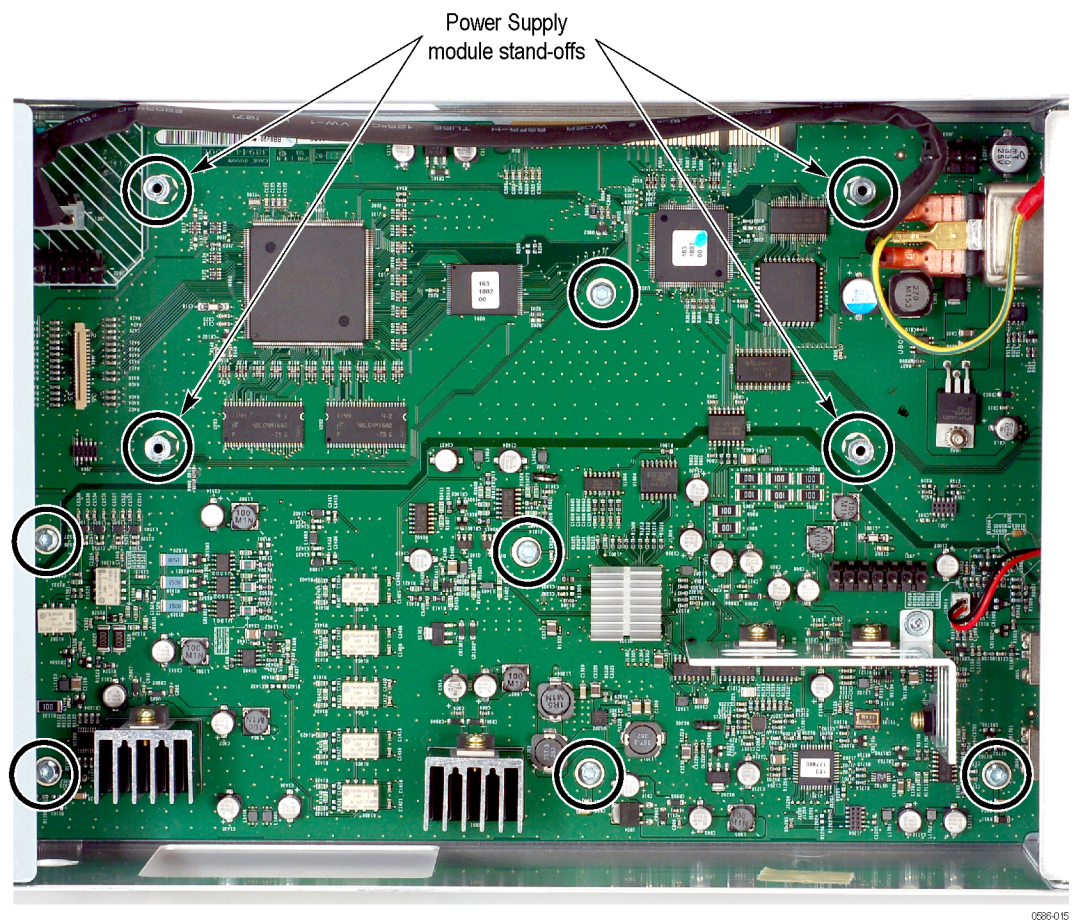

Figure 27: Location of Main board retaining screws and stand-offs

12. Carefully slide the Main board forward until the connectors clear the rear panel and then lift the board out of the instrument.

Installation. To install the Main board, perform the removal procedure in reverse order. Be aware of the following:

NOTE. *After you replace the Main board, you must reset the instrument serial number. (See page 30, Resetting the serial number.)*

- Correctly orient the plastic BNC insulator on each front BNC before you install the Main board in the chassis. (See Figure 18 on page 50.)
- Tighten the Rear BNC Insulator board retaining screws to 0.88 N m.
- Attach the wave washers, then the nuts, and then the BNC insulators to the rear BNCs before you install the BNC cover plate. (See Figure 28.)
- Tighten the BNC cover plate retaining screws to 0.49 N m.
- **Option GL only:** Tighten the GPIB connector jack screws to 0.88 N m.
- Tighten the six Main board retaining screws to 0.88 N m; tighten the four Main board stand-offs for the Power Supply module to 0.49 N m.

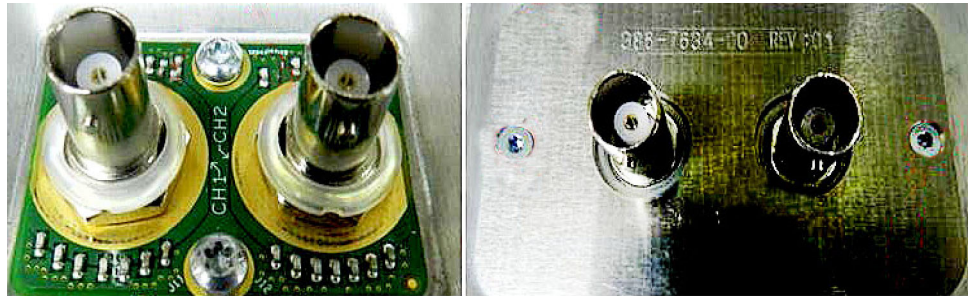

Figure 28: Installing the rear BNC washers, nuts, and insulators

Troubleshooting

This section contains the following information to help you isolate faulty modules in the AFG2021 Arbitrary Function Generator.

- Troubleshooting trees – Show how to find and isolate faulty modules.
- Diagnostics – Describes the diagnostics supplied with the arbitrary function generator, its operation, and status messages.

After you troubleshoot and identify a faulty part, use the *Removal and installation procedures* section to exchange the modules. (See page 37.)

Troubleshooting tools and equipment

You may need the following tools and equipment to troubleshoot the arbitrary function generator.

Table 4: Troubleshooting equipment

Tools and equipment	Example
Digital multimeter (DMM)	3.5 or greater digit DMM
Oscilloscope with probe	Tektronix TDS1000 or TDS2000 series oscilloscope

Troubleshooting tree

To isolate a problem to a specific troubleshooting procedure, use the following troubleshooting tree. The tree makes use of internal diagnostic routines to speed fault isolation to a module.



WARNING. *To prevent electrical shock, do not touch the heat sink of the Power Supply module. There are potentially dangerous voltages present on the heat sink of the Power Supply module.*

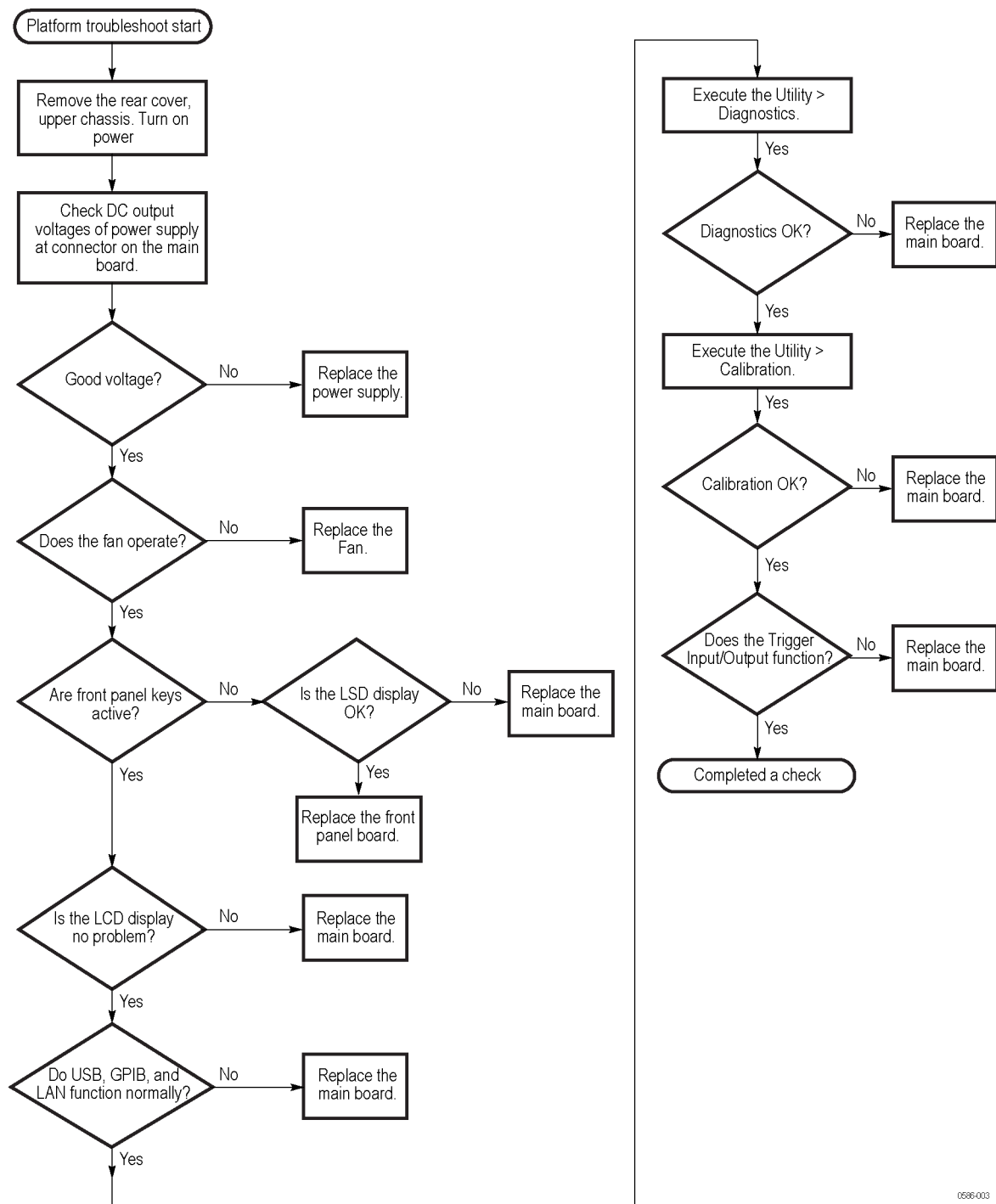

0566-003

Figure 29: Troubleshooting tree

Diagnostics

Power-on diagnostic test

When you power on the AFG2021, the instrument automatically executes a diagnostic test for all the diagnostics items before the Startup screen appears.

When an error is detected, the diagnostic test displays an error message. If you see such an error message, press the **OK** button to proceed with the next step. The AFG2021 software starts. When the AFG2021 contains an unresolved error, the test cannot be conducted normally.

Utility menu diagnostic test

This procedure uses internal routines to verify that the instrument is operating correctly.

Prerequisites. Before you run the Utility menu diagnostic test:

- Power on the instrument and allow a 20 minute warm-up before doing this procedure.
- The instrument must be operating at an ambient temperature between +0 °C and +50 °C.

Procedure. Perform the following steps to run the Utility menu diagnostic test:

1. Select Execute Diagnostics in the Utility menu (**Utility > -more- > Diagnostics/Calibration > Execute Diagnostics**).
2. Wait until the test is completed.
3. Verify that the diagnostic test passed.
 - If the diagnostic completes without finding any problems, the message “PASSED” is displayed.
 - When an error is detected during diagnostic execution, the instrument shows an error code. (See page 65, *Diagnostic error codes*.)
4. Press any front panel button to exit from the diagnostics test.

Calibration diagnostic test

This procedure uses internal routines to verify that the instrument is operating correctly.

Prerequisites. Before you run the Calibration diagnostic test:

- Power on the instrument and allow a 20 minute warm-up before doing this procedure.
- An ambient temperature is between +20 °C and +30 °C.

Procedure. Perform the following steps to run the internal routines that confirm basic functionality and proper adjustment:



WARNING. *To prevent the loss of data, do not turn off the power while executing calibration. If the power is turned off while the calibration is in progress, data stored in internal nonvolatile memory may be lost.*

1. Select the Execute Calibration in the Utility menu (**Utility > -more- > Diagnostics/Calibration > Execute Calibration**).
2. Wait until the test is completed.
3. Verify that the diagnostic test passed.
 - If the diagnostic completes without finding any problems, the message “PASSED” is displayed.
 - When an error is detected during diagnostic execution, the instrument shows an error code. (See page 65, *Diagnostic error codes*.)
4. Press any front panel button to exit from the calibration test.

Diagnostic error codes

If a diagnostic test detects a malfunction, the character string “Fail” and the associated error code is displayed. The following table describes the error codes and lists the related modules.

Table 5: Error codes

Error code	Description
— Calibration —	
1101	CH1 Internal offset calibration failure
1103	CH1 Output offset calibration failure
1105	CH1 Output gain Calibration failure
1201	CH1 x3dB attenuator calibration failure
1203	CH1 x6dB attenuator calibration failure
1205	CH1 x10dB attenuator calibration failure
1207	CH1 x20dB 1 attenuator calibration failure
1209	CH1 x20dB 2 attenuator calibration failure
1211	CH1 Filter calibration failure
1301	CH1 Sine Flatness calibration failure
1401	CH1 ASIC TINT calibration failure
1403	CH1 ASIC SGEN calibration failure
1405	CH1 ASIC clock duty calibration failure
— Diagnostics —	
2100	Calibration data not found
2101	Calibration data checksum
2102	Calibration data invalid
2201	ASIC1 memory failure
2203	ASIC1 Overheat
— Output Diagnostics —	
2301	CH1 Internal offset failure
2303	CH1 Output offset failure
2305	CH1 Output gain failure
2401	CH1 x3dB attenuator failure
2403	CH1 x6dB attenuator failure
2405	CH1 x10dB attenuator failure
2407	CH1 x20dB 1 attenuator failure
2409	CH1 x20dB 2 attenuator failure
2411	CH1 Filter failure
2413	CH1 x20dB 3 attenuator failure
2501	CH1 Sine Flatness failure

Diagrams

The diagram in this section shows how the modules in the AFG2021 instrument connect together.

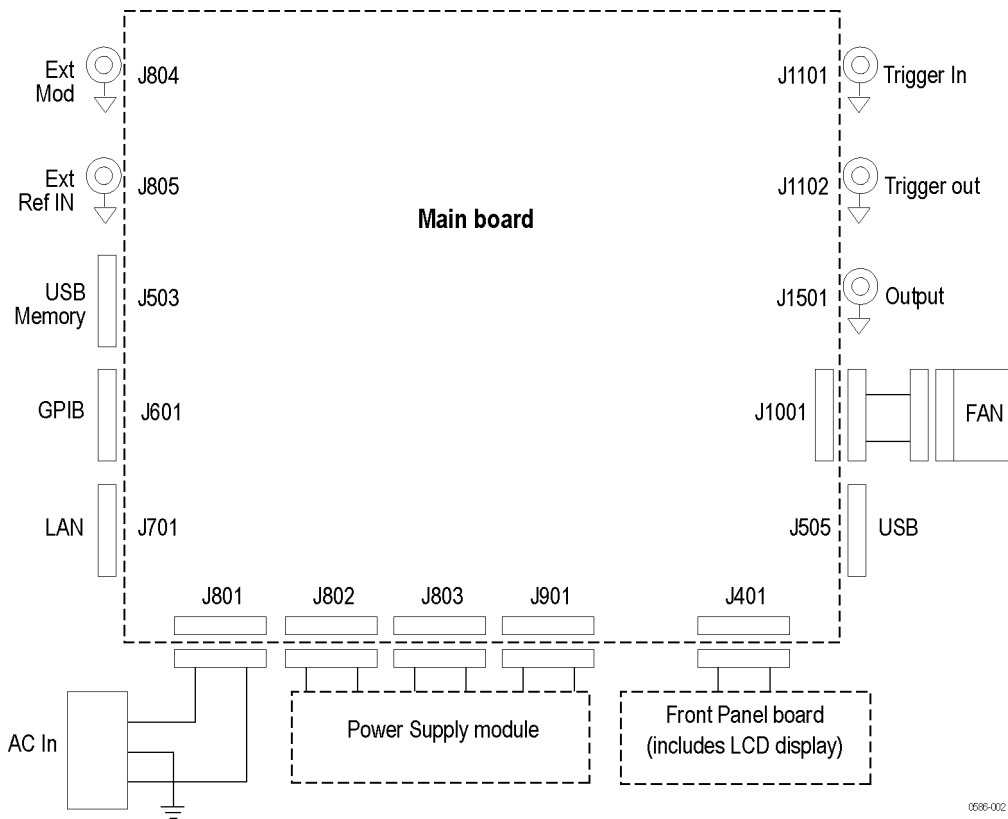

Figure 30: Interconnections for the AFG2021

Replaceable parts

This section contains a list of the replaceable modules for the AFG2021 Arbitrary Function Generator. Use this list to identify and order replacement parts.

Parts ordering information

Replacement parts are available through your local Tektronix field office or representative.

Changes to Tektronix instruments are sometimes made to accommodate improved components as they become available and to give you the benefit of the latest circuit improvements. Therefore, when ordering parts, it is important to include the following information in your order.

- Part number
- Instrument type or model number
- Instrument serial number
- Instrument modification number, if applicable

If you order a part that has been replaced with a different or improved part, your local Tektronix field office or representative will contact you concerning any change in part number.

Using the replaceable parts list

This section contains a list of the mechanical and/or electrical components that are replaceable for the arbitrary function generator. Use this list to identify and order replacement parts. The following table describes each column in the parts list.

Table 6: Parts list column descriptions

Column	Column name	Description
1	Figure & index number	Items in this section are referenced by component number.
2	Tektronix part number	Use this part number when ordering replacement parts from Tektronix.
3	Instrument model	This indicates the model of instrument that uses this item.
4 and 5	Serial number	Column four indicates the serial number at which the part was first effective. Column five indicates the serial number at which the part was discontinued. No entries indicates the part is good for all serial numbers.
6	Qty	This indicates the quantity of parts used.
7	Name & description	An item name is separated from the description by a colon (:). Because of space limitations, an item name may sometimes appear as incomplete. Use the U.S. Federal Catalog handbook H6-1 for further item name identification.

Abbreviations Abbreviations conform to American National Standard ANSI Y1.1-1972.

Table 7: Front panel assembly replaceable parts (See Figure 31.)

Fig. & index no.	Tektronix part no.	Serial no. effective	Serial no. discount'd	Qty.	Name & description
31-					Front panel assembly exploded diagram
-1	367-0558-00			1	HANDLE, CARRYING; TEK SILVER GRAY
-2	200-5159-00			1	COVER, FRONT BOOT CAP TEK SILVER GRAY
-3	366-0896-00			1	PUSH BUTTON, POWER
-4	366-0863-00			1	ASSEMBLY, KNOB WITH RETAINER CLIP; 0.685 DIAMETER
-5	335-2559-00			1	LABEL, FRONT PANEL, AFG2021 ENGLISH
	335-2680-00			1	LABEL, FRONT PANEL, AFG2021 FRENCH
	335-2681-00			1	LABEL, FRONT PANEL, AFG2021 ITALIAN
	335-2682-00			1	LABEL, FRONT PANEL, AFG2021 GERMAN
	335-2683-00			1	LABEL, FRONT PANEL, AFG2021 SPANISH
	335-2684-00			1	LABEL, FRONT PANEL, AFG2021 JAPANESE
	335-2685-00			1	LABEL, FRONT PANEL, AFG2021 SIMPLIFIED CHINESE
	335-2686-00			1	LABEL, FRONT PANEL, AFG2021 STANDARD CHINESE
	335-2687-00			1	LABEL, FRONT PANEL, AFG2021 KOREAN
	335-2688-00			1	LABEL, FRONT PANEL, AFG2021 RUSSIAN
	335-2715-00			1	LABEL, FRONT PANEL, AFG2021 PORTUGUESE
-6	211-0101-00			4	SCREW, MACHINE; 4-40 X 0.25, FLH, 100 DEG, ZINC PLATED STEEL, T8
-7	335-2560-00			1	LABEL, NOMENCLATURE AFG2021
-8	202-0486-00			1	CASE, FRONT, PC/ABS, PLASTIC BLEND, TEK GRAY, SAFETY CONTROLLED
-9	211-1129-00			11	SCREW, MACHINE; 2-56 X 0.312L, TORX T8, PAN HEAD, STEEL, ZINC FINISH
-10	850-0201-00			1	ASSEMBLY; DISPLAY, COLOR
-11	260-2934-00			1	SWITCH, KEYPAD, FRONT PANEL
-12	220-0265-00			3	NUT, PLAIN, HEX; 0.5-28 X 0.625 HEX, BRS, NKL PL
-13	210-1544-00			3	WASHER, SPRING; 0.610 OD X 0.490 ID X 0.007 THK, WAVE SHAPE, STAINLESS STEEL
-14	878-0575-00			1	CIRCUIT BOARD ASSY; FRONT BNC INSULATOR; 389442300; UNTESTED
-15	878-0585-00			1	CIRCUIT BOARD ASSY; FRONT PANEL (4 LAYERS); 389446100; UNTESTED

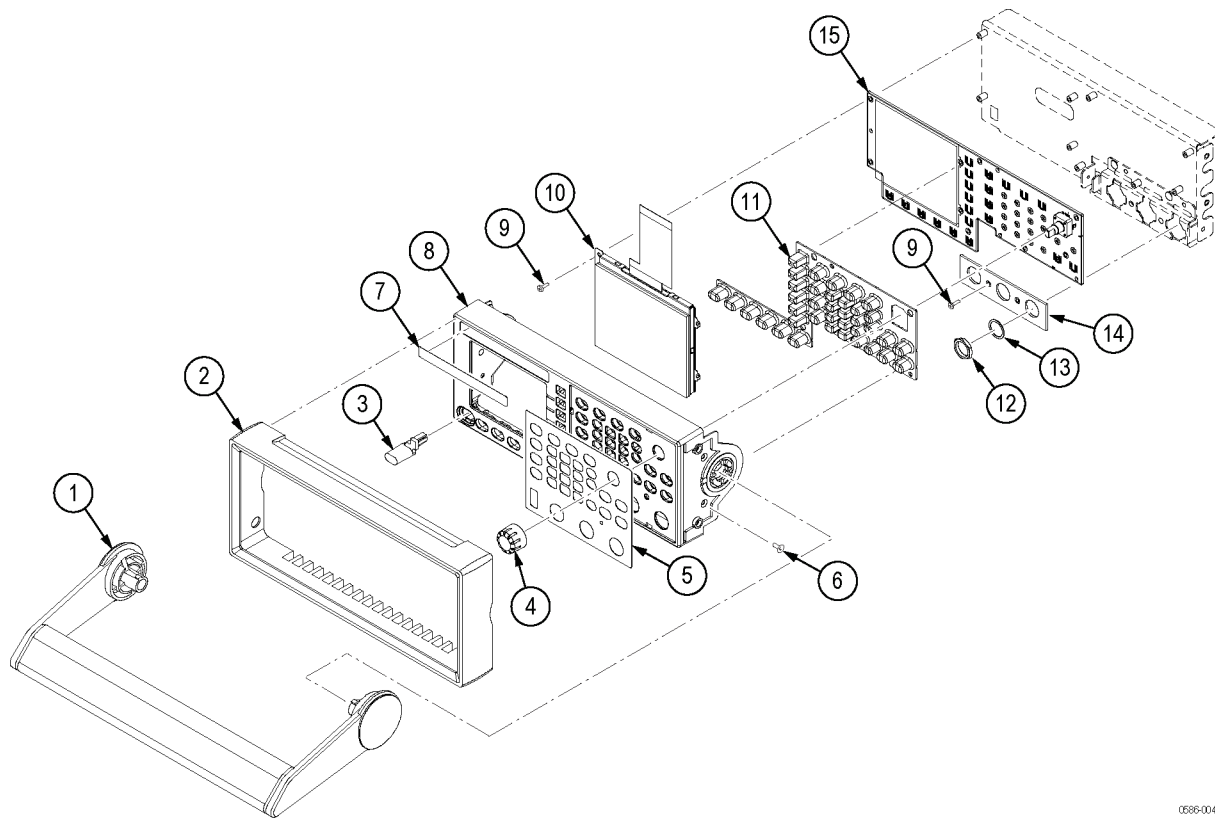

0585-004

Figure 31: Front panel assembly exploded diagram

Table 8: Chassis assembly replaceable parts (See Figure 32.)

Fig. & index no.	Tektronix part number	Serial no. effective	Serial no. discont'd	Qty.	Name & description
32-					Chassis assembly exploded diagram
-01	441-2661-00			1	FRONT SHIELDING COVER; 0.039IN THICK AL 5052 H32
-02	211-0101-00			8	SCREW, MACHINE; 4-40 X 0.25, FLH, 100 DEG, ZINC PLATED STEEL, T8
-03	441-2648-00			1	CHASSIS, ASSEMBLY MAIN CHASSIS, SIMPLE VERSION, SAFETY CONTROLLED
	441-2647-00			1	CHASSIS, ASSEMBLY MAIN CHASSIS, OPTION GL VERSION, SAFETY CONTROLLED
-04	335-2582-01	C010244		1	LABEL, REAR PANEL, SIMPLE VERSION, 0.010 PC FILM, LEXAN, W/ADHESIVE BACK, SAFETY CONTROLLED
	335-2603-01	C010244		1	LABEL, REAR PANEL FULL, OPTION GL VERSION, 0.010 PC FILM, LEXAN, W/ADHESIVE BACK, SAFETY CONTROLLED
	335-2582-00		C010243	1	LABEL, REAR PANEL, SIMPLE VERSION, 0.010 PC FILM, LEXAN, W/ADHESIVE BACK, SAFETY CONTROLLED
	335-2603-00		C010243	1	LABEL, REAR PANEL FULL, OPTION GL VERSION, 0.010 PC FILM, LEXAN, W/ADHESIVE BACK, SAFETY CONTROLLED
-05	441-2651-00			1	ENCLOSURE TOP, SAFETY CONTROLLED
-06	200-5152-00			1	COVER, REAR BOOT CAP, TEK BLUE; SAFETY CONTROLLED
-07	342-1135-00			7	INSULATOR, BSHG: NYLON, 0.509 X 0.470 D HOLE X 0.687 OD X 0.035 T
-08	131-6521-00			1	CONTACT, ELEC; EMI, CLIP-ON, 0.38 L X 0.460 W (2 CONTACTS) X 0.45 HIGH, ELECTROLESS NICKEL PLATE
-09	211-1272-00			15	SCREW, MACHINE; 6-32 X 0.250, PNH, STL, ZNPL, T-15 TORX DR
-10	174-6018-00			1	FFC CABLE ASSY, PITCH = 0.5MM FRONT PANEL TO MAINBOARD
-11	679-6514-02			1	CIRCUIT BOARD ASSY, SIMPLE VERSION; A70, CPU, MAIN BOARD; 389442400; UNTESTED
	679-6531-02			1	CIRCUIT BOARD ASSY, OPTION GL VERSION; A70, CPU, MAIN BOARD; 389442400; UNTESTED
-12	213-1152-00			4	HEX NUT
-13	342-1228-00			1	PWR INSULATOR (PROTECTION COVER)
-14	119-7271-03			1	POWER SUPPLY; AC-DC; 150 W MAX IN; 87-264 VAC 47-63 HZ, 100-127 VAC 360-440 HZ IN; +4.3V @ 2.3A, +7.5V @ 3.2A, +18V @ 2A, -18V @ 2A OUT; SAFETY CONTROLLED
-15	174-5926-00			1	CA ASSY, SP (INLET, POWER)
-16	210-1539-00			1	WASHER, LOCK; #8 INTL, 0.02 THK, STEEL, ZINC FINISH

Table 8: Chassis assembly replaceable parts (See Figure 32.) (cont.)

Fig. & index no.	Tektronix part number	Serial no. effective	Serial no. discont'd	Qty.	Name & description
-17	196-3496-00			1	LEAD, ELECTRICAL; 18 AWG, 4.0 L, 5-4 SAFETY CONTROLLED
-18	119-7255-00			1	FILTER, EMI; AC LINE FILTER;3.0A, 115-250VAC, 50/60HZ, IEC INPUT, FAST-ON/SOLDER LUG OUTPUT, CHASSIS MOUNT, SAFETY CONTROLLED
-19	119-7780-XX			1	FAN, DC ASSEMBLY
-20	213-1150-00			2	SCREW, FLAT HEAD, T15 FAN SCREW, M5X10
-21	210-0056-00			2	WASHER, LOCK; #10 SPLIT, 0.047 THK, SI BRZ NP
-22	213-1061-00			2	JACKSCREW; 6-32 EXT THD, M3.5 X 0.6-6 INT THD, ZINC PLATED STEEL
-23	878-0574-00			1	CIRCUIT BOARD ASSY; REAR BNC INSULATOR; 389442200; UNTESTED
-24	210-1544-XX			2	WASHER, SPRING; 0.610 OD X 0.490 ID X 0.007 THK, WAVE SHAPE, STAINLESS STEEL
-25	220-0265-00			2	NUT, PLAIN, HEX; 0.5-28 X 0.625 HEX, BRS, NKL PL
-26	386-7634-00			1	BNC COVER
-27	131-6363-00			1	EMI GASKET; GROUNDING, 0.320 L X 0.365 W (2 CONTACTS) X 0.110 DEEP, ELECTROLESS NICKEL PLATE

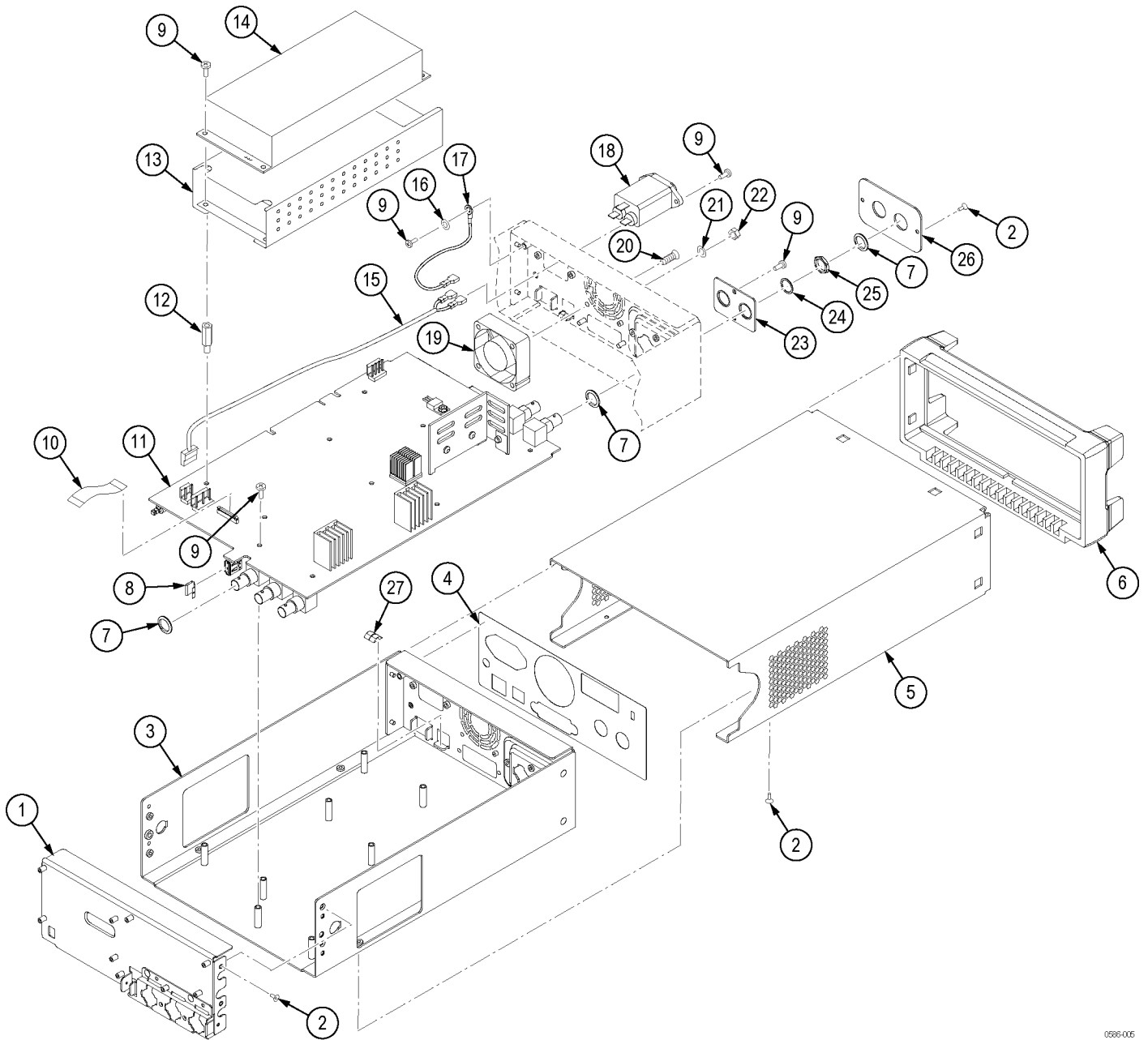

0586-005

Figure 32: Chassis assembly exploded diagram