

(revised 4/4/05)

MÖSSBAUER EFFECT

Advanced Laboratory, Physics 407
University of Wisconsin
Madison, Wisconsin 53706

Abstract

This experiment allows one to measure the Mössbauer Effect for the 14.37 keV line of Fe^{57} with pure Fe^{57} and stainless steel Fe^{57} absorbers. The technique uses a Kr filled proportional counter with a thin Be window as a detector for the gamma rays. The Co^{57} source is mounted on a moving shaft to provide velocity modulation. The internal magnetic field in the pure Fe^{57} absorber permits observation of the hyperfine splitting of the 14.37 keV level.

Theory

If an excited nucleus decays from one energy level to a lower energy level by emitting a gamma, then the energy of the gamma is:

$$h\nu = E_0 - \Delta E \text{ and } \Delta E \approx \frac{E_0^2}{2Mc^2}.$$

E_0 is the energy difference between the levels, ΔE is the recoil kinetic energy of the nucleus, and M is the mass of the recoil nucleus.

This ΔE is usually much larger than the line broadening caused by thermal motion of the atoms. However, in some crystals, the atoms are bound very tightly to the crystal lattice and there is a reasonable probability that the entire lattice will share the recoil momentum. The mass of the crystal is 10^{20} or so times greater than that of a single atom and so the corresponding ΔE is extremely small. This phenomenon is called “recoilless emission”. The gammas produced by recoilless emission thus have energy E_0 to a very good approximation and thus can be resonantly absorbed in the same type of nucleus by exciting these nuclei from the lower level back to the upper level.

This phenomenon was discovered by Rudolph L. Mössbauer in 1958 while he was still a graduate student. He gained a Nobel prize in 1961 for this discovery.

The extreme sharpness of the energy of the gammas is hard to believe. The gammas emitted from the 14.4 keV excited level of Fe^{57} have an energy spread of 10^{-11} of their energy. This is the same ratio as 1 second compared with 3,000 years!

The extremely narrow width of these lines has provided scientists with an important tool for studying a wide variety of problems. For example:

1. It has been possible to show that the gammas emitted by the decay of Ir^{191} nuclei have an energy width which is equal to that expected from the uncertainty principle and the lifetime of Ir^{191} . (Eisberg & Resnick, page 635).
2. Gammas have been found to lose energy as they go “up hill” in a gravitational field. This “gravitational red-shift” has been measured on earth with a height difference of only 22.5 meters.

3. The precise energy gammas can be used to examine the tiny shift of nuclear energy levels due to small effects such as those caused by various nearby electron configurations. It is also possible to observe the level splitting caused by nuclear quadrupole moments.

The gamma energy can be varied very slightly by moving the source so that the Doppler effect changes the gamma energy as seen by the stationary absorber. Since the line width is about 10^{-11} of the full energy, the velocities needed to affect the absorption are about:

$$\begin{aligned}
 & 10^{-11} \times c \\
 = & 10^{-11} \times 3 \times 10^8 \text{ m/sec} \\
 = & 3 \text{ mm/sec.}
 \end{aligned}$$

In this experiment, the source is mounted on a loudspeaker cone which is moved slowly with velocities up to ± 10 mm/sec.

Line Shape

The experimentally observed shape of the transmission line in a Mössbauer experiment can be approximated by (Frauenfelder, page 7):

$$N(E) \propto \sigma_0 \frac{\Gamma_{expt.}^2}{\Gamma_{expt.}^2 + 4(E - E_0)^2},$$

where σ_0 is the maximum Mössbauer absorption cross section given by (Frauenfelder, page 7):

$$\sigma_0 = 2\pi\lambda^2 \left[\frac{2I_e + 1}{2I_g + 1} \right] \left[\frac{1}{\alpha_t + 1} \right].$$

- $\Gamma_{expt.}$ = experimentally observed full width at half maximum of the absorption peak.
- E_0 = Mössbauer line energy.
- $\lambda = 2\pi \times \lambda$, the Mössbauer line wavelength.
- I_e = nuclear spin of the excited state.

- I_g = nuclear spin of the ground state.
- α_t = total internal conversion coefficient.

It is assumed that both the emission and absorption lines are unsplit. For Fe^{57} :

- $E_0 = 14.41$ keV.
- $I_e = 3/2$, $I_g = 1/2$.
- $\alpha_t = 8.21$.
- $\sigma_0 = 2.57 \times 10^{-18}$ cm².

The value of $\Gamma_{\text{expt.}}$ depends primarily on the effective thicknesses T_s and T_a of the source and absorber. In the limit of thin source and absorber thicknesses the value is exactly twice the natural line width Γ of the source and absorber. The natural line width, Γ , is a fundamental property of a particular nuclear excited state and, in principle, can be calculated from theory. Also, the natural line width is related to the nuclear state lifetime τ via the uncertainty principle as $\tau = \frac{\hbar}{\Gamma}$. Measuring line widths is a standard technique for measuring lifetimes which are too short for direct time measurements.

In this experiment the enriched absorbers are moderately thick so that the thin absorber value for $\Gamma_{\text{expt.}}$ cannot be used. A method for calculating the ratio $\Gamma_{\text{expt.}}/\Gamma$ as well as the values of this ratio for the dimensionless quantities T_s , T_a in the range 0–10 is given by Margulies and Ehrman. Calculations are extended for absorber thicknesses of up to 30 by Hafemeister and Shera. The effective absorber thickness T_a is given by $T_a = f(N_a/A)a\sigma_0t'$, where:

- f = recoilless fraction.
- N_a = Avagadro's number.
- A = atomic weight.
- a = fractional abundance of resonant absorbers.
- t' = absorber thickness in g/cm².

Using the Debye model, f can be written (Frauenfelder, page 30):

$$f = \exp \left\{ -\frac{3}{2} \frac{R}{k\theta_D} \left[1 + 4 \left(\frac{T}{\theta_D} \right)^2 \int_0^{\theta_D/T} \frac{x}{e^x - 1} dx \right] \right\}.$$

For the Fe^{57} stainless steel absorber NER-512:

- $R = \frac{E_0^2}{2Mc^2}$, the recoil nucleus kinetic energy.
- $k = 8.6174 \times 10^{-11}$ MeV $^\circ\text{K}^{-1}$, the Boltzmann constant.
- $T = 23^\circ\text{C}$, 296°K .
- $\theta_D = 490^\circ\text{K}$, the Debye Temperature.
- $f = \exp(-0.179) = 0.836$.
- $a = 0.9073$.
- $t' = 1$ mg/cm².
- $T_a = 20.50$.

The same formula is used for the effective source thickness T_s . Rather than try to calculate this, Campbell used $T_s = 0$ as a reasonable estimate since the source backing is copper, which does not resonantly absorb. For $T_s = 0$, $T_a = 20.5$, the value $\Gamma_{\text{expt.}}/\Gamma$ from Hafemeister and Shera is 6.1.

Distortion of the Mössbauer Line

1. Isomer Shift

This is due to the interaction of the nuclear charge distribution and the electron charge density at the nucleus. Penetration of the nucleus by S electrons shifts the nuclear energy levels. The amount of penetration is dependent on the chemical environment of the atom. As a result, the center of the transmission peak is shifted away from 0 mm/sec.

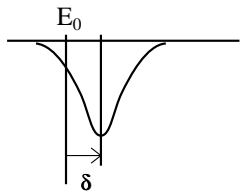

2. Quadrupole Splitting

This is caused by interaction of the nuclear quadrupole moment with the electric field gradient at the site of the nucleus. The resulting line is split into two parts:

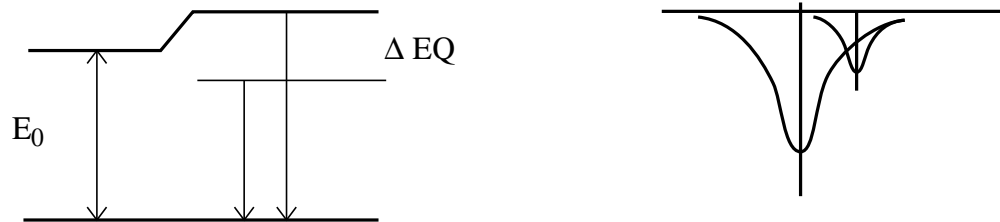

3. HF Splitting - Nuclear Zeeman Effect

The Zeeman splitting is due to the interaction of the nuclear magnetic dipole with the magnetic field at the site of the nucleus. For the Fe^{57} source and the pure iron absorber the resulting spectrum has six peaks since the 14.4 keV level is a transition between a $I=3/2$ level and a $I=1/2$ level with different magnetic moments.

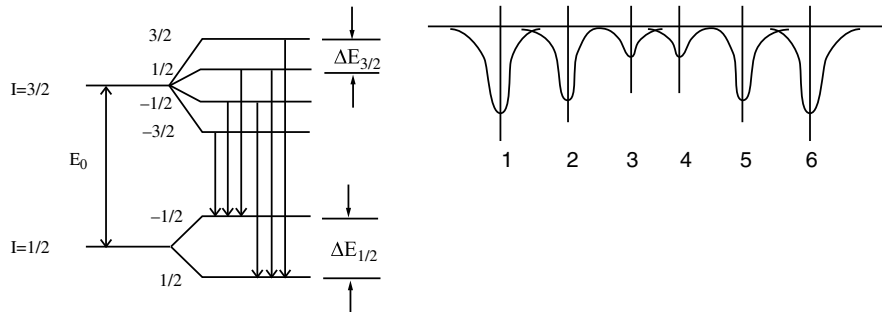

Apparatus

Co⁵⁷ Source (Isotope Products Laboratories)

The present installed source had a nominal strength of 2 mCi on Mar. 2002. Co^{57} has a half-life of 270 days with a decay:

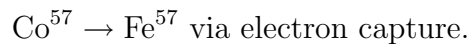

The decay produces gammas of 6.5, 14.37, 122 and 136 keV. The 14.37 keV gamma is needed for the Mössbauer experiment and must be distinguished from the other gammas.

The source is electroplated on a 0.0005 inch copper backing sealed in a plastic holder and has an active diameter of about 1/4 inch. The holder is mounted on an aluminum rod that is attached to a vibrator.

Enriched Fe⁵⁷ Iron Foil Absorber (New England Nuclear NER-511)

The iron absorber is mounted in the aperture of 2 sheets of lead and lucite. The absorber has a lead height of 5 cm and width 3.3 cm. This height and width are enough to intercept all direct paths from the source to the proportional counter window that do not pass through the foil. The absorber thickness is 1.9 mg/cm^2 and the iron atoms are 92.36% Fe^{57} .

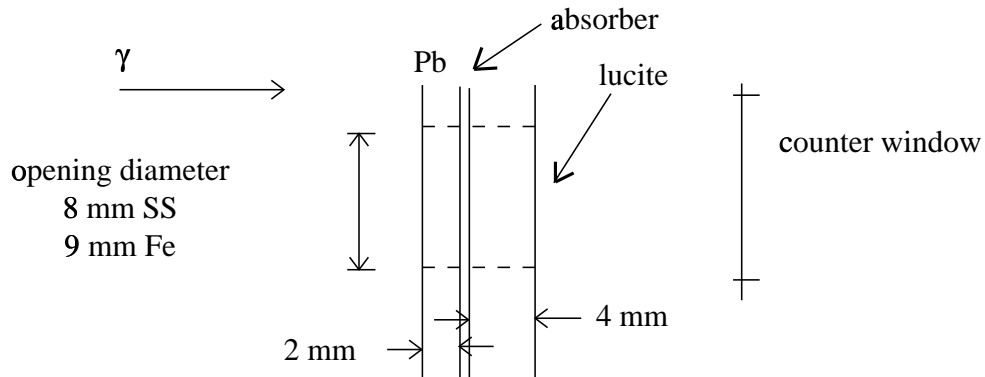

Iron and SS Absorber Configuration

Enriched Fe^{57} Stainless Steel Absorber (New England Nuclear NER-512)

The stainless iron absorber is mounted in a similar manner to the Iron Foil. The lead height is 3 cm and width 2.5 cm. The opening diameter is 8 mm. The absorber thickness is 1.0 mg/cm^2 and the iron atoms are 90.73% Fe^{57} .

Detector (Reuter-Stokes Model P3-1605-261)

The detector is a proportional gas chamber with 97% Krypton and 3% CO_2 . The pressure is 760 Torr and the resolution is 15% FWHM for gammas of 14.4 keV at an anode voltage of +1850 volts (measured 3/97). The body is stainless steel with an aluminum liner. The gammas enter via a thin (0.010 inch) beryllium window of diameter 1 inch.

High Voltage Supply (Fluke Model 415B)

The high voltage supply is used to provide a regulated voltage of about +1850 volts to the center wire of the proportional detector. The connection is made

via the HV input on a special distribution box that feeds the HV to the proportional tube via the preamplifier.

Pre-amplifier (Ortec model 109)

The pre-amplifier is a low noise solid state charge preamplifier which matches the high output impedance of the proportional tube to the low impedance of the output coaxial cable. The output pulse when terminated is about 25 mV with a decay time of about 100 μ s. The power for the preamp is supplied from the NIM crate containing the amplifier and other modules.

Amplifier (Ortec model 575A)

The amplifier is used to amplify the preamp output to a level of several volts, suitable for driving the direct input on the pulse height analyzer. The amplifier should be set for positive input pulses and bipolar output pulses. Care should be taken to not saturate the amplifier output.

Multi Channel Analyzer and MCA Control Software

An Ortec Model 916A analog to digital converter PC plug-in card is used to analyze and store pulses from the amplifier or the Controller circuit so as to:

- (a) Select the best gain and avoid saturation.
- (b) Recognize the 14.4 keV gammas.
- (c) Record the velocity distribution of source events in data taking mode.

The 916A is under the control of the MCA program found in the MCA directory of the PC. A manual for the software is available.

Single Channel Analyzer (Ortec model 406A)

The Upper and Lower window discriminator settings are adjusted so that there is an output only for input pulse heights within a window containing the 14.4 keV line. For pulses within the window the SCA puts out a fixed pulse of about 5 V amplitude and 0.5 μ s width. The output goes to the gate input of the Mössbauer Controller.

Mechanical Drive System/Mechanical Vibrator

The source is mounted on a small rod driven by a mechanical vibrator. The velocity of the shaft is measured by a small transducer coil which intercepts the flux from a small permanent magnet on the shaft. The vibrator and source are driven from the Mössbauer Controller by a servo system so that the velocity of the loudspeaker cone is proportional to an input triangular waveform.

Pulser (Ortec model 419)

The pulser puts out precision pulses at a fixed frequency and variable height. The pulser is needed to adjust the upper and lower window settings of the single channel analyzer for the 14.4 keV line.

Mössbauer Effect Controller

The controller circuit is contained in a rack-mounted chassis and has several functions. One function is to accept the transducer signal and produce the drive voltage for the mechanical vibrator such that the source motion is a waveform proportional to the source velocity.

A second function is to accept gamma ray triggers from the output of the SCA and use them to open an internal gate which samples the velocity waveform and produces an analog output pulse whose amplitude is proportional to the source velocity corresponding to that trigger. This output analog pulse is connected to the MCA input. The MCA pulse height distribution is then a display of the velocity probability distribution for the 14.4 KeV decay gamma rays.

A third function is to provide a monitor signal of the triangular waveform that is driving the mechanical vibrator. This signal can be used to measure the period of the source motion.

Method

The vibrator drive electronics is adjusted to produce parabolic motion of the source, i.e., a triangular velocity function. Signals produced by the proportional counter are amplified and sent to the SCA, which is set to produce a digital output only when a 14.4 keV gamma-ray is detected. This pulse

is used as a trigger for the Mössbauer Controller and produces an analog pulse, with amplitude linearly dependent on the source velocity. This pulse is displayed on the MCA. Hence, the transmission of the 14.4 keV line by the absorber is plotted as a function of the source velocity. The experimental arrangement is diagrammed below.

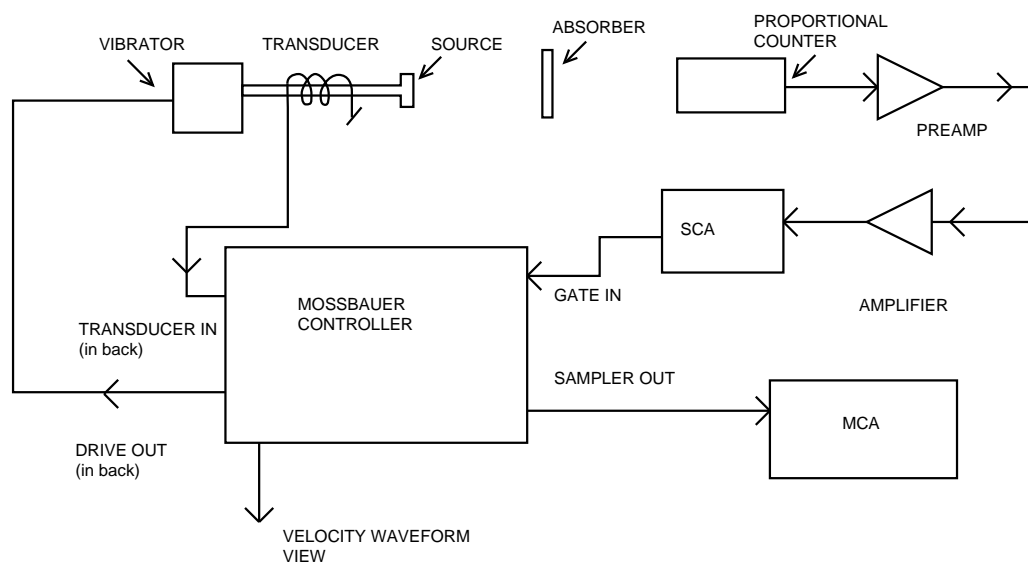

MOSSBAUER SCHEMATIC

Procedure

1. Read the method described in Melissinos, pages 272-279. This experiment uses a similar procedure although some of the apparatus is different.
2. Source Platform Settings. The Mössbauer Controller has helipot for setting the frequency and amplitude of the source vibrations. The frequency is generally set to about 1 Hz (pot=1.50) and the amplitude to about 1 mm (pot=0.60). The amplitude, which sets the velocity range, should be large enough see all six peaks for the normal Fe foil. The stainless steel foil is non-magnetic and does not result in a Zeeman line splitting, thus there is only one peak at $v=0$. Here the velocity excursion can be reduced, which permits a more accurate determination of the line width.

The system may take 5 min. or so to stabilize. If the amplitude and/or the frequency settings are changed, the system will have to restabilize.

3. Fe^{57} Spectrum. The proportional counter voltage should be set to +1850 volts. Set the Ortec amplifier to accept positive signals and set the gain controls to Coarse=20, Fine=8.2. With the absorber removed, place the proportional counter about 2 cm from the exit of the lead collimator. The pre-amp output rate should be several kHz. Output pulses from the amplifier should be about 4 μs long and range up to saturation at +6 or +7 volts. Connect the amplifier directly to the MCA input. A short run should show two distinct gamma rays peaks within the first 200 channels. Collect enough data so that the 14.4 KeV peak is well defined. You will have to note the channel numbers which define suitable upper and lower bounds that define the peak.

4. SCA Adjustment. The SCA limits should be set to pass at least 95% of the area under the 14.4 keV peak. Determine the channel on each side of the peak that has about 15% of the counts at maximum. Set the pulser amplitude to each of these channels in turn and for each case connect the pulser output to the SCA input. This procedure will permit setting the upper and lower discriminator window settings.
5. Collecting Data. With the equipment connected as in the block diagram, mount the absorber on the detector side of the lead collimator. The proportional counter should be positioned a few cm downstream of the collimator and lined up with the hole in the collimator. Connect the Sampler output to the MCA input. The Sampler pulses should be positive, about 1 μ s long, with a varying amplitude of about 6-7 Volts. When the pulses are displayed on the MCA the pattern should sweep back and forth evenly and fill a large portion of the screen. For velocity calibration the end points of the sweep should be displayed. With the absorber removed, the count rate should be uniform over all the channels. If not, check to see that the monitor signal is triangular.
6. Velocity Calibration. You will have to calibrate the motion of the source in terms of an absolute velocity. This can be done by measuring the amplitude of the motion of the end of the shaft with a telescope mounted on a traveling stage. You should be able to measure the amplitude to a few hundredths of a mm if the motion has stabilized. The amplitude, driving waveform shape, and the frequency will then be enough information to calculate the velocity function. Remember that the loudspeaker drive voltage is a triangular function but only if the error voltage is zero is the velocity motion also triangular. The plots below indicate velocity and position calculated as a function of time for a typical set of parameters.

Derive an expression for the velocity and position as a function of time. Note that the motion corresponds to the case of constant acceleration. From these expressions calculate the value of V_{max} in terms of the amplitude X_{max} and the period T.

7. Analysis - Enriched Stainless Steel Absorber. Take a statistically significant data set for the stainless steel foil. Since there is only a single peak you may want to adjust the source motion amplitude so that the

signal occupies a significant portion of the data display. Determine the experimental line width and the natural line width, correcting for finite foil thickness. Calculate the lifetime of the 14.4 keV state and compare to the accepted value.

8. Analysis - Enriched Iron Absorber. Determine the value of the internal local B field which has given rise to the Zeeman splitting of the lines. Compare to the accepted value. Use the following procedure to guide you through the analysis:
 - a) Write the energy difference between the three pairs 1-6, 2-5, and 3-4 in terms of $\Delta E_{3/2}$ and $\Delta E_{1/2}$. Refer to the figure on p.7.
 - b) Express $\Delta E_{3/2}$ and $\Delta E_{1/2}$ in units of $\mu_{NM} \langle B \rangle$.
 - c) Label the observed peaks with the appropriate $m_{3/2} \rightarrow m_{1/2}$ quantum numbers.
 - d) Calculate $\langle B \rangle$ for each of the three pairs and average the results.
 - e) What is your experimental velocity resolution? Can the sign of $\langle B \rangle$ be determined with an iron external field magnet? You would need to calculate the the shift of one of the lines with the external field magnet on.

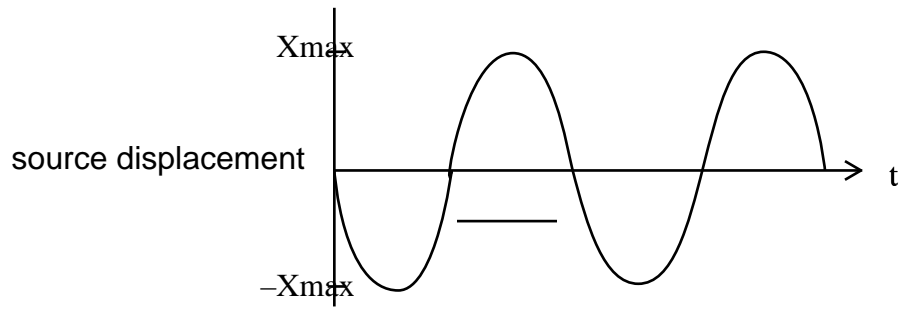
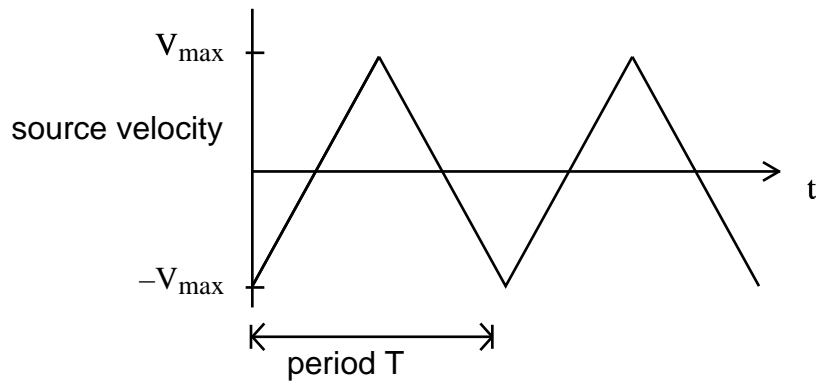

Velocity Calibration of the MCA

REFERENCES

1. Melissinos, "Experiments in Modern Physics", Academic Press, pp. 265-279.
2. H. Frauenfelder, "The Mössbauer Effect", Benjamin, New York, 1962.
3. S. Margulies, J. Ehrman, Nucl. Inst. Methods **12**, 131 (1961).
4. D. Hafemeister, E. Shera, Nucl. Inst. Methods **41**, 133 (1966).
5. Eisberg and Resnick, "Quantum Physics", Wiley, pp. 634-636.