

AFG2021
Arbitrary/Function Generator
Quick Start User Manual



071-2926-00

Tektronix

AFG2021
Arbitrary/Function Generator
Quick Start User Manual

Copyright © Tektronix. All rights reserved. Licensed software products are owned by Tektronix or its subsidiaries or suppliers, and are protected by national copyright laws and international treaty provisions.

Tektronix products are covered by U.S. and foreign patents, issued and pending. Information in this publication supersedes that in all previously published material. Specifications and price change privileges reserved.

TEKTRONIX and TEK are registered trademarks of Tektronix, Inc.

Additional trademark statements can be added here.

Contacting Tektronix

Tektronix, Inc.
14150 SW Karl Braun Drive
P.O. Box 500
Beaverton, OR 97077
USA

For product information, sales, service, and technical support:

- In North America, call 1-800-833-9200.
- Worldwide, visit www.tektronix.com to find contacts in your area.

Warranty

Tektronix warrants that the product will be free from defects in materials and workmanship for a period of three (3) years from the date of original purchase from an authorized Tektronix distributor. If the product proves defective during this warranty period, Tektronix, at its option, either will repair the defective product without charge for parts and labor, or will provide a replacement in exchange for the defective product. Batteries are excluded from this warranty. Parts, modules and replacement products used by Tektronix for warranty work may be new or reconditioned to like new performance. All replaced parts, modules and products become the property of Tektronix.

In order to obtain service under this warranty, Customer must notify Tektronix of the defect before the expiration of the warranty period and make suitable arrangements for the performance of service. Customer shall be responsible for packaging and shipping the defective product to the service center designated by Tektronix, shipping charges prepaid, and with a copy of customer proof of purchase. Tektronix shall pay for the return of the product to Customer if the shipment is to a location within the country in which the Tektronix service center is located. Customer shall be responsible for paying all shipping charges, duties, taxes, and any other charges for products returned to any other locations.

This warranty shall not apply to any defect, failure or damage caused by improper use or improper or inadequate maintenance and care. Tektronix shall not be obligated to furnish service under this warranty a) to repair damage resulting from attempts by personnel other than Tektronix representatives to install, repair or service the product; b) to repair damage resulting from improper use or connection to incompatible equipment; c) to repair any damage or malfunction caused by the use of non-Tektronix supplies; or d) to service a product that has been modified or integrated with other products when the effect of such modification or integration increases the time or difficulty of servicing the product.

THIS WARRANTY IS GIVEN BY TEKTRONIX WITH RESPECT TO THE PRODUCT IN LIEU OF ANY OTHER WARRANTIES, EXPRESS OR IMPLIED. TEKTRONIX AND ITS VENDORS DISCLAIM ANY IMPLIED WARRANTIES OF MERCHANTABILITY OR FITNESS FOR A PARTICULAR PURPOSE. TEKTRONIX' RESPONSIBILITY TO REPAIR OR REPLACE DEFECTIVE PRODUCTS IS THE SOLE AND EXCLUSIVE REMEDY PROVIDED TO THE CUSTOMER FOR BREACH OF THIS WARRANTY. TEKTRONIX AND ITS VENDORS WILL NOT BE LIABLE FOR ANY INDIRECT, SPECIAL, INCIDENTAL, OR CONSEQUENTIAL DAMAGES IRRESPECTIVE OF WHETHER TEKTRONIX OR THE VENDOR HAS ADVANCE NOTICE OF THE POSSIBILITY OF SUCH DAMAGES.

[W16 – 15AUG04]

Table of Contents

| | |
|--|------|
| General safety summary | iv |
| Compliance Information | vi |
| EMC Compliance | vi |
| Safety Compliance | viii |
| Environmental Considerations | x |
| Preface | xi |
| Where to find more information | xi |
| Conventions used in this manual | xi |
| Getting started | 1 |
| General features | 1 |
| Before installation | 1 |
| Standard accessories | 2 |
| Optional accessories | 3 |
| Operating requirements | 4 |
| Power the instrument on and off | 5 |
| Change instrument settings at power-on | 6 |
| Erase instrument setups and waveforms from memory | 7 |
| Perform instrument self test and self calibration | 7 |
| Select a local language | 9 |
| Protect your instrument from misuse | 9 |
| Floating ground | 11 |
| Protect your DUT | 12 |
| Update your instrument firmware | 13 |
| Connect to a network | 16 |
| Equivalent output circuits | 21 |
| Instrument front panel, interface, and rear panel | 22 |
| Front panel overview | 22 |
| Parts of the screen interface | 23 |
| Default setup | 24 |
| Select waveform | 26 |
| Select run mode | 29 |
| Adjust waveform parameters | 30 |
| Channel output On/Off | 33 |
| Rear panel | 33 |
| Operating basics | 35 |
| Quick tutorial: How to select a waveform and adjust parameters | 35 |
| Quick tutorial: How to generate a sine waveform | 36 |
| Quick tutorial: Instrument help system | 38 |

| | |
|--|----|
| Operating Basics..... | 39 |
| Generate a pulse waveform..... | 39 |
| Save/recall instrument setups..... | 41 |
| Generate an arbitrary waveform..... | 42 |
| Modify an arbitrary waveform..... | 43 |
| Generate noise/DC..... | 47 |
| Generate a burst waveform..... | 47 |
| Sweep a waveform..... | 50 |
| Modulate a waveform..... | 53 |
| Trigger out..... | 57 |
| Set up load impedance..... | 59 |
| Add noise..... | 60 |
| Reference clock..... | 62 |
| Synchronous operation..... | 63 |
| USB memory..... | 64 |
| Utility menu..... | 65 |
| Save/recall instrument setup..... | 67 |
| Save a screen image..... | 69 |
| Security menu..... | 70 |
| ArbExpress..... | 73 |
| Application examples..... | 81 |
| Measurement of filter characteristics..... | 81 |
| Motor speed control by pulse-width modulation..... | 82 |
| Carrier null (frequency modulation)..... | 83 |
| Index | |

List of Figures

| | |
|---------------------------------------|----|
| Figure 1: Instrument dimensions | 4 |
| Figure 2: Fuse and fuse adapter..... | 10 |

General safety summary

Review the following safety precautions to avoid injury and prevent damage to this product or any products connected to it.

To avoid potential hazards, use this product only as specified.

Only qualified personnel should perform service procedures.

While using this product, you may need to access other parts of a larger system. Read the safety sections of the other component manuals for warnings and cautions related to operating the system.

To avoid fire or personal injury

Use proper power cord. Use only the power cord specified for this product and certified for the country of use.

Ground the product. This product is grounded through the grounding conductor of the power cord. To avoid electric shock, the grounding conductor must be connected to earth ground. Before making connections to the input or output terminals of the product, ensure that the product is properly grounded.

Observe all terminal ratings. To avoid fire or shock hazard, observe all ratings and markings on the product. Consult the product manual for further ratings information before making connections to the product.

Do not apply a potential to any terminal, including the common terminal, that exceeds the maximum rating of that terminal.

Power disconnect. The power cord disconnects the product from the power source. Do not block the power cord; it must remain accessible to the user at all times.

Do not operate without covers. Do not operate this product with covers or panels removed.

Do not operate with suspected failures. If you suspect that there is damage to this product, have it inspected by qualified service personnel.

Avoid exposed circuitry. Do not touch exposed connections and components when power is present.

Do not operate in wet/damp conditions.

Do not operate in an explosive atmosphere.

Keep product surfaces clean and dry.

Provide proper ventilation. Refer to the manual's installation instructions for details on installing the product so it has proper ventilation.

Terms in this manual These terms may appear in this manual:



WARNING. *Warning statements identify conditions or practices that could result in injury or loss of life.*



CAUTION. *Caution statements identify conditions or practices that could result in damage to this product or other property.*

Symbols and terms on the product

These terms may appear on the product:

- DANGER indicates an injury hazard immediately accessible as you read the marking.
- WARNING indicates an injury hazard not immediately accessible as you read the marking.
- CAUTION indicates a hazard to property including the product.

The following symbol(s) may appear on the product:



Earth Terminal



Chassis Ground



Mains Disconnected
OFF (Power)



Mains Connected
ON (Power)

Compliance Information

This section lists the EMC (electromagnetic compliance), safety, and environmental standards with which the instrument complies.

EMC Compliance

EC Declaration of Conformity – EMC

Meets intent of Directive 2004/108/EC for Electromagnetic Compatibility. Compliance was demonstrated to the following specifications as listed in the Official Journal of the European Communities:

EN 61326-1 2006. EMC requirements for electrical equipment for measurement, control, and laboratory use. ^{1 2 3}

- CISPR 11:2003. Radiated and conducted emissions, Group 1, Class A
- IEC 61000-4-2:2001. Electrostatic discharge immunity
- IEC 61000-4-3:2002. RF electromagnetic field immunity
- IEC 61000-4-4:2004. Electrical fast transient / burst immunity
- IEC 61000-4-5:2001. Power line surge immunity
- IEC 61000-4-6:2003. Conducted RF immunity
- IEC 61000-4-11:2004. Voltage dips and interruptions immunity

EN 61000-3-2:2006. AC power line harmonic emissions

EN 61000-3-3:1995. Voltage changes, fluctuations, and flicker

European contact.

Tektronix UK, Ltd.
Western Peninsula
Western Road
Bracknell, RG12 1RF
United Kingdom

¹ This product is intended for use in nonresidential areas only. Use in residential areas may cause electromagnetic interference.

² Emissions which exceed the levels required by this standard may occur when this equipment is connected to a test object.

³ For compliance with the EMC standards listed here, high quality shielded interface cables should be used.

**Australia / New Zealand
Declaration of
Conformity – EMC**

Complies with the EMC provision of the Radiocommunications Act per the following standard, in accordance with ACMA:

- CISPR 11:2003. Radiated and Conducted Emissions, Group 1, Class A, in accordance with EN 61326-1:2006.

Australia / New Zealand contact.. Baker & McKenzie
Level 27, AMP Centre
50 Bridge Street
Sydney NSW 2000, Australia

Safety Compliance

EC Declaration of Conformity – Low Voltage

Compliance was demonstrated to the following specification as listed in the Official Journal of the European Communities:

Low Voltage Directive 2006/95/EC.

- EN 61010-1: 2001. Safety requirements for electrical equipment for measurement control and laboratory use.

U.S. Nationally Recognized Testing Laboratory Listing

- UL 61010-1:2004, 2nd Edition. Standard for electrical measuring and test equipment.

Canadian Certification

- CAN/CSA-C22.2 No. 61010-1:2004. Safety requirements for electrical equipment for measurement, control, and laboratory use. Part 1.

Additional Compliances

- IEC 61010-1: 2001. Safety requirements for electrical equipment for measurement, control, and laboratory use.

Equipment Type

Test and measuring equipment.

Safety Class

Class 1 – grounded product.

Pollution Degree Description

A measure of the contaminants that could occur in the environment around and within a product. Typically the internal environment inside a product is considered to be the same as the external. Products should be used only in the environment for which they are rated.

- Pollution Degree 1. No pollution or only dry, nonconductive pollution occurs. Products in this category are generally encapsulated, hermetically sealed, or located in clean rooms.
- Pollution Degree 2. Normally only dry, nonconductive pollution occurs. Occasionally a temporary conductivity that is caused by condensation must be expected. This location is a typical office/home environment. Temporary condensation occurs only when the product is out of service.
- Pollution Degree 3. Conductive pollution, or dry, nonconductive pollution that becomes conductive due to condensation. These are sheltered locations where neither temperature nor humidity is controlled. The area is protected from direct sunshine, rain, or direct wind.
- Pollution Degree 4. Pollution that generates persistent conductivity through conductive dust, rain, or snow. Typical outdoor locations.

| | |
|---|--|
| Pollution Degree | Pollution Degree 2 (as defined in IEC 61010-1). Note: Rated for indoor use only. |
| Installation (Overvoltage) Category Descriptions | <p>Terminals on this product may have different installation (overvoltage) category designations. The installation categories are:</p> <ul style="list-style-type: none">■ Measurement Category IV. For measurements performed at the source of low-voltage installation.■ Measurement Category III. For measurements performed in the building installation.■ Measurement Category II. For measurements performed on circuits directly connected to the low-voltage installation.■ Measurement Category I. For measurements performed on circuits not directly connected to MAINS. |
| Overvoltage Category | Overvoltage Category II (as defined in IEC 61010-1) |

Environmental Considerations

This section provides information about the environmental impact of the product.

Product End-of-Life Handling

Observe the following guidelines when recycling an instrument or component:

Equipment recycling. Production of this equipment required the extraction and use of natural resources. The equipment may contain substances that could be harmful to the environment or human health if improperly handled at the product's end of life. To avoid release of such substances into the environment and to reduce the use of natural resources, we encourage you to recycle this product in an appropriate system that will ensure that most of the materials are reused or recycled appropriately.



This symbol indicates that this product complies with the applicable European Union requirements according to Directives 2002/96/EC and 2006/66/EC on waste electrical and electronic equipment (WEEE) and batteries. For information about recycling options, check the Support/Service section of the Tektronix Web site (www.tektronix.com).

Restriction of Hazardous Substances





This product is classified as Monitoring and Control equipment, and is outside the scope of the 2002/95/EC RoHS Directive.

Preface

This manual describes the installation and operation of the Tektronix AFG2021 Arbitrary/Function Generator along with basic operations and concepts.

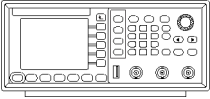
Where to find more information

The following table lists related documentation available for your instrument. The documentation is available on the Product Documentation CD and on the Tektronix Web site (www.tektronix.com/manuals).

| Item | Purpose | Location |
|-------------------------|--|--|
| Quick Start User Manual | Unpacking, Installation, Tutorials, Operation, and Overviews |  WWW.Tektronix.com |
| Built-in Help | UI Help and Operation |  |
| Programmer Manual | Menu Structures, User Interface, and Programming Information |  WWW.Tektronix.com |
| Service Manual | Self-service and Performance test |  WWW.Tektronix.com |
| Technical Reference | Specifications and performance verification procedures |  WWW.Tektronix.com |
| ArbExpress Software CD | Waveform creation Import waveforms from oscilloscope or PC |  WWW.Tektronix.com |

Conventions used in this manual

The following icons are used throughout this manual.

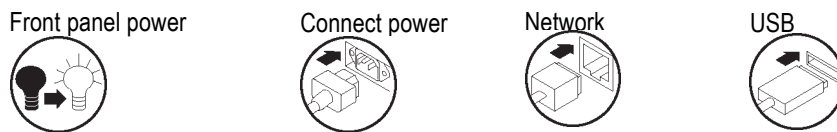

The soft keys along the right side of the display are called bezel buttons in this manual. In other documents, they may also be called option buttons or side-menu buttons.

Getting started

General features

The AFG2021 Arbitrary/Function Generator offers the functionality of three generators in one:

- 20 MHz Function Generator
- 10 MHz Pulse Generator
- 14 bits Arbitrary Waveform Generator

The following table describes some of the general features of your instrument.

| Feature | Description |
|-------------------------------|--|
| Channel | 1 |
| Sine | 20 MHz |
| Pulse | 10 MHz |
| Memory | 128K 14bit |
| Sampling Rate | 250 MS/s |
| Amplitude | 10 V _{p-p} |
| Display | Color TFT LCD |
| Interface | USB GPIB (AFG2021with option GL only) LAN (AFG2021with option GL only) |
| Synchronous operation | Available |
| Ground isolation | Available |
| Context-sensitive Help system | Instrument help available in multiple languages |
| ArbExpress® Software | Waveform creation and editing tool software |

Before installation

Inspect the instrument carton for external damage. If the carton is damaged, notify the carrier.

Remove the instrument from its package and check that it has not been damaged in transit. Verify that the carton contains the instrument and its standard accessories.

Standard accessories

Unpack the instrument and check that you received all items listed as Standard Accessories. Check the Tektronix Web site (www.tektronix.com) for the most current information.

Standard accessories

| Description | Tektronix part number |
|--|----------------------------|
| AFG2021 Arbitrary/Function Generator Quick Start User Manual | |
| English (Option L0) | 071-2926-xx |
| French (Option L1) ¹ | 071-2927-xx |
| Italian (Option L2) ¹ | 071-2928-xx |
| German (Option L3) ¹ | 071-2929-xx |
| Spanish (Option L4) ¹ | 071-2930-xx |
| Japanese (Option L5) ¹ | 071-2931-xx |
| Portuguese (Option L6) ¹ | 071-2936-xx |
| Simple Chinese (Option L7) ¹ | 071-2932-xx |
| Traditional Chinese (Option L8) ¹ | 071-2933-xx |
| Korean (Option L9) ¹ | 071-2934-xx |
| Russian (Option L10) ¹ | 071-2935-xx |
| No printed manual (Option L99) | - - - |
| AFG2021 Documentation CD containing the following PDF documents: | 063-4441-xx |
| AFG2021 Arbitrary/Function Generators Programmer Manual | 077-0587-xx |
| AFG2021 Arbitrary/Function Generators Service Manual | 077-0586-xx |
| AFG2021 Arbitrary/Function Generators Specifications and Performance Verification Manual | 077-0588-xx |
| ArbExpress Waveform Creation and Editing Tool for Tektronix Arbitrary/ Function Generators Software CD with instructions | 063-3763-xx |
| USB cable | 174-4401-xx |
| Power cord | |
| Specs | Description |
| 115 V, 60 Hz | North America (Option A0) |
| 220 V, 50 Hz | Universal Euro (Option A1) |
| 240 V, 50 Hz | United Kingdom (Option A2) |
| 240 V, 50 Hz | Australia (Option A3) |
| 220 V, 50 Hz | Switzerland (Option A5) |

| Description | | Tektronix part number |
|-------------------------|--|-----------------------|
| 100 V, 110/120 V, 60 Hz | Japan (Option A6) | - - - |
| 220 V, 50 Hz | China (Option A10) | - - - |
| 240 V, 50 Hz | India (Option A11) | - - - |
| 110/220 V, 60 Hz | Brazil (Option A12) | - - - |
| - - - | No power cord or AC adapter (Option A99) | - - - |

¹ These manuals contain a language overlay for the front panel controls.

Optional accessories

The following optional accessories are recommended for your instrument:

Optional accessories

| Description | Tektronix part number |
|--|-----------------------|
| 50 Ω BNC cable, double-shielded, 91 cm (36 in) | 012-0482-XX |
| 50 Ω BNC cable, double-shielded, 250 cm (98 in) | 012-1256-XX |
| 50 Ω BNC terminator | 011-0049-XX |
| GPIB interface cable, double-shielded, 200 cm (79 in) | 012-0991-XX |
| Rackmount kit | RMU2U |
| Fuse adapter | 013-0345-XX |
| 0.125 fuse set (contains three fuses) | 159-0454-XX |

NOTE. To ensure the EMC compliance listed in the Specifications, connect only high quality shielded cables to this instrument. High quality shielded cables typically are braid and foil types that have low impedance connection to shielded connectors at both ends.

Operating requirements

The following information and figure describe temperature, clearance, and power supply operating requirements of the instrument.

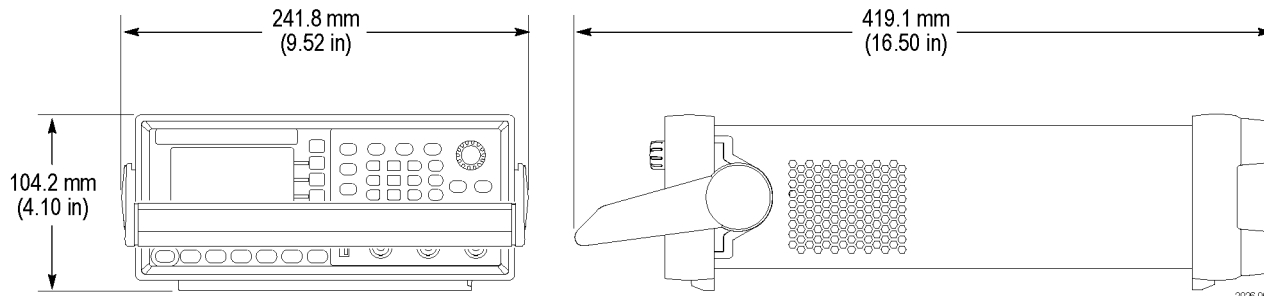

Figure 1: Instrument dimensions

Environmental requirements

Clearance. When placing the instrument on a cart or bench, observing the following clearance requirements:

- Sides: 50 mm (2 in)
- Rear: 50 mm (2 in)

Temperature. Before operating the instrument, ensure the ambient temperature is between 0 °C to +50 °C (+32 °F to +122 °F).



CAUTION. To ensure proper cooling, keep both sides of the instrument clear of obstructions.

Power supply requirements

Source voltage and frequency. 100 V to 240 V, 50 Hz to 60 Hz or 115 V, 400 Hz.

Power Consumption. 60 W



WARNING. To reduce the risk of fire and shock, ensure that the mains supply voltage fluctuations do not exceed 10% of the operating voltage range:

Power the instrument on and off

The following procedures show you how to apply power to the instrument and turn it on and off.



CAUTION. *This product will not function with the rear feet in the down position. Ensure they are raised before instrument setup.*

Power on To turn apply power to the instrument and turn it on, do the following:

1. Insert the AC power cord into the power receptacle on the rear panel and the other end into a properly grounded power outlet.

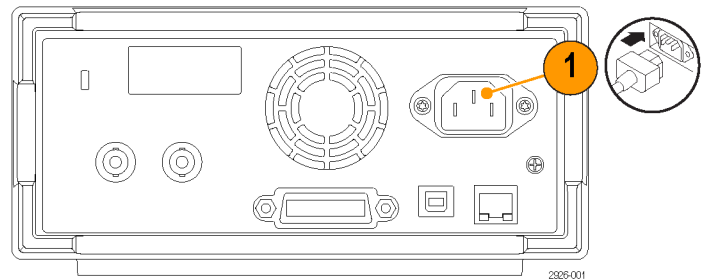

2. Push the front-panel power button to power on the instrument.

NOTE. *Wait until the front panel display shows that the instrument has passed all power-on self tests before using the instrument.*

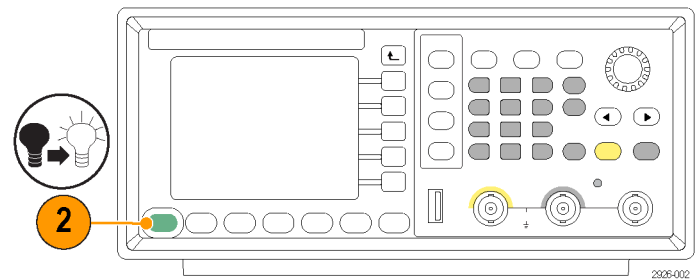

Power off To turn the instrument off, do the following:

1. Push the front-panel power button to power off the instrument.

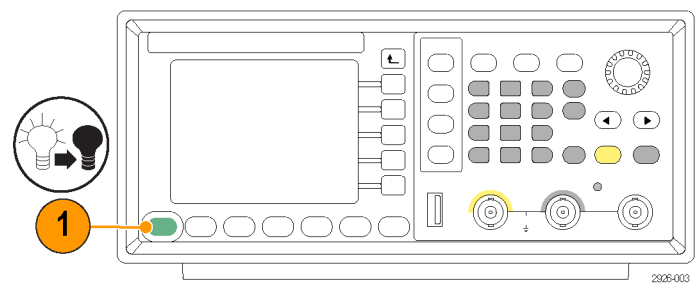

Change instrument settings at power-on

The default settings are restored when you power on the instrument. You can change the power-on settings to the last powered-off settings from the Utility menu using the following procedure.

1. Push the front-panel Utility button.
2. Push the System bezel button.

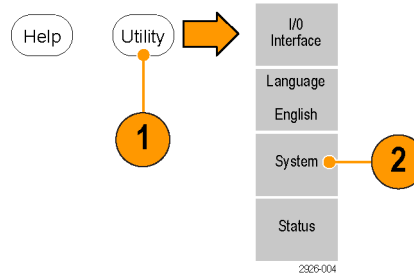

3. Push the Power On bezel button to select from the following the power on settings.

- **Default** restores the default settings when the instrument is powered on.
- **Last** restores the same settings as when the instrument was last powered off.

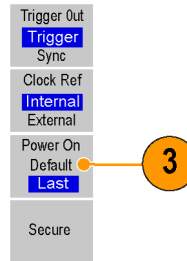

Erase instrument setups and waveforms from memory

You can also erase all instrument setups and waveforms from the instrument internal memory using the following procedure.

NOTE. You can restore the instrument to its default settings at any time without erasing memory by using the default setup procedure. (See page 24.)

1. Push the front-panel Utility button.
2. Push the System bezel button.

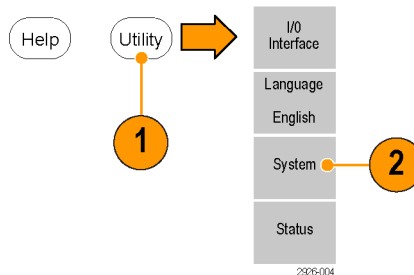

3. Push the Secure bezel button.

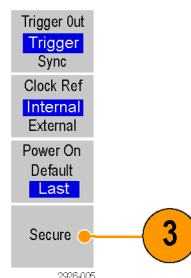

Perform instrument self test and self calibration

The instrument performs a limited set of hardware tests at power-on. You can also perform the following manual diagnostics and/or self calibration using the Utility menu:

NOTE. Disconnect all the cables from the instrument before performing a self test or a self calibration.

- **Diagnostics (Self test):** Perform the self test to verify that your instrument is operating correctly.
- **Calibration (Self calibration):** The self calibration mainly checks DC accuracy using the internal calibration routines. Perform at least once a year to maintain

DC accuracy. It is recommended that the self calibration should be performed along with a periodic check.

NOTE. *If you need to verify that the instrument meets the warranted specifications, do the complete set of performance verification procedures provided in the Specifications and Performance Verification manual.*

CAUTION. *Do not power off the instrument while executing self calibration. If the power is turned off during self calibration, data stored in the internal memory may be lost.*

1. Push the front-panel Utility button.
2. Push the -more- bezel button.
3. Push the Diagnostics/Calibration bezel button.

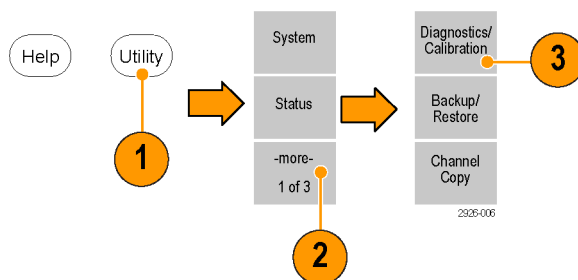

4. Do one of the following:

NOTE. *Before executing self calibration, ensure that the ambient temperature is between +20 °C and +30 °C (+68 °F to +86 °F), and allow a 20 minute warm-up period.*

Execute Diagnostics:
Push this bezel button to execute the instrument diagnostics.

Execute Calibrations:
Push this bezel button to execute self calibration.

5. If the diagnostics or calibration completes without any errors, the message "PASSED" is displayed.



Select a local language

You can select the language you want displayed on the instrument screen. When you power on the instrument for the first time, English is selected by default. After you select a desired language, all the bezel menus, pop-up messages, and built-in help are displayed in the specified language. The main display area is not translated.

1. Push the front-panel Utility button.
2. Push the Language bezel button.

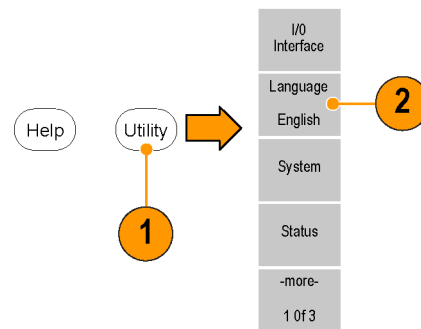

3. Select the desired language.
You can select from English, French, German, Japanese, Korean, Simplified Chinese, Traditional Chinese, and Russian.



NOTE. If you selected a language option with the purchase of the instrument, you should have received a front panel overlay.

Protect your instrument from misuse

Check input and output connectors

When connecting a cable, be sure to distinguish the input connector from the output connectors to avoid making the wrong connection.

NOTE. The instrument input and output connectors are floating inputs/outputs. (See page 11, Floating ground.)

1. Locate the Channel Output and the Trigger Output connectors on the front panel.
2. Locate the Trigger Input on the front panel.

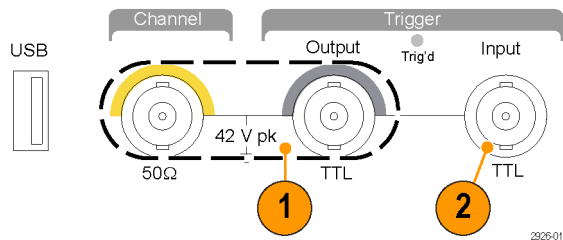

3. Locate the Ext Mod Input and the Ext Ref Input connectors on the rear panel.

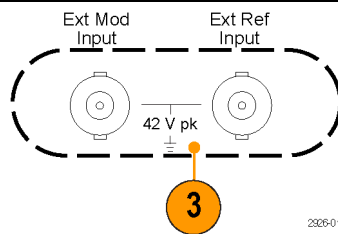

WARNING. To avoid personal injury due to electric shock, do not apply voltages in excess of 42 Vpk to any BNC connector ground or to the chassis ground.

CAUTION. Do not short output pins or apply external voltages to Output connectors. The instrument may be damaged.

CAUTION. Do not apply excessive inputs over +5 V to Trigger Input connector. The instrument may be damaged.

Use fuse adapter

The instrument will be damaged if a large DC or AC voltage is applied to the output or input connectors. To protect the output circuits, a fuse adapter is provided as an optional accessory. When the instrument is used by students or other inexperienced users, always attach the fuse adapter to the output connectors to avoid damage. (See page 3, *Optional accessories*.)

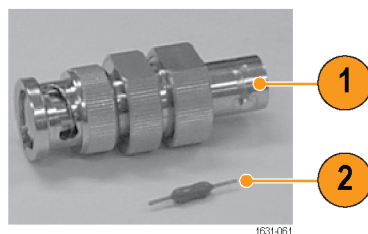

Figure 2: Fuse and fuse adapter

1. Fuse adapter
2. Fuse

Floating ground

Since the common input and output channels of the arbitrary/function generator are electrically isolated from the chassis ground (the instrument chassis and ground line of the AC connector), you can make a floating connection between the instrument and other equipment.

All the BNC connectors are connected to the common ground, and the remote interface connector is connected to the chassis ground.



CAUTION. *The maximum rated voltage between the chassis ground and common ground is 42 V_{p-p} (DC + peak AC). When the potential voltage between the chassis ground and common ground goes over 42 V_{p-p}, the internal protective circuit will be activated to protect the circuits. However, higher voltage may cause the internal circuits in the instrument to be damaged.*

When a potential voltage exists between the chassis ground and common ground, a short circuit from output to ground causes the instrument internal fuse to open and the output is stopped. If the fuse opens, you need to contact your local Tektronix Service Support.

When a potential voltage exists between the common ground and chassis ground, short-circuiting between them may lead to excessive current flow and the internal or external circuits may be damaged.



WARNING. *To prevent electrical shock, use this product so that the sum of the floating voltage and the output voltage of the instrument does not exceed 42 V_{pk}. Do not touch the center of the BNC while the equipment is in use.*

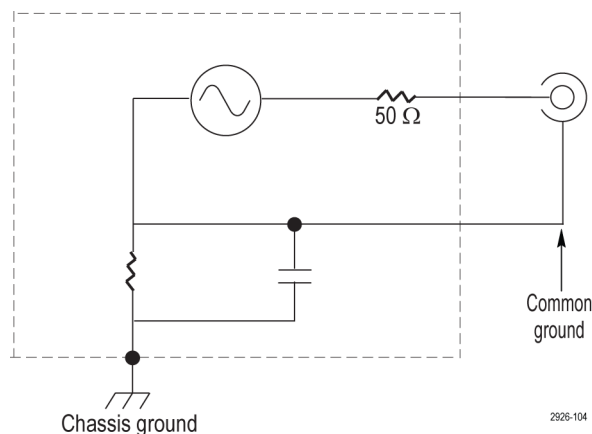

Protect your DUT

Use care when you connect the instrument Channel Output to your DUT (device under test). To avoid damage to your DUT, the following preventive measures are provided. Follow these steps to set the limit values for high level and low level.

1. Push the Output Menu bezel button.
2. Push the Limit bezel button.

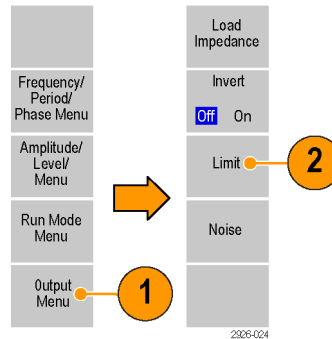

3. Push the High Limit bezel button.
4. Notice that in this example, High Limit is set to 5.000 V, and Low Limit is set to -5.000 V.

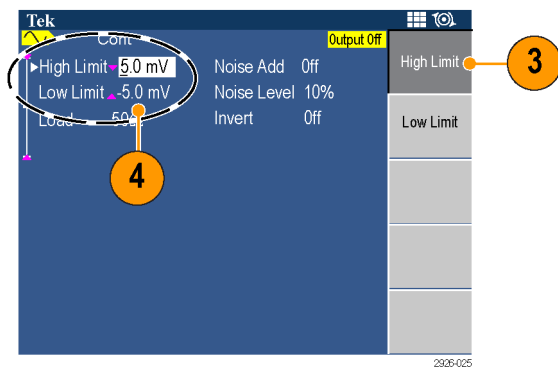

5. Use the numeric keys or the general purpose knob to set the High Limit to 50 mV and the Low Limit to -50 mV.
6. Push the front-panel Sine button to display the waveform parameter. Confirm that High and Low voltage levels were changed.

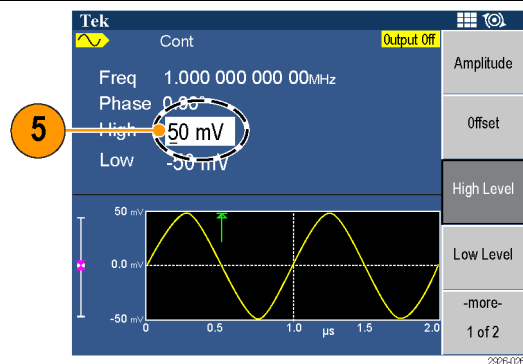

NOTE. You cannot enter any values greater than 50 mV for High level.

NOTE. When you set limit values using the Output Menu, a level indicator is displayed at the left end of the graph area.

Update your instrument firmware

You can use the front-panel USB connector to update your instrument firmware using a USB memory device.



CAUTION. *Updating your instrument firmware is a sensitive operation which may damage your instrument if you do not follow all instructions carefully. To prevent damage to the instrument, do not remove the USB memory device or power off the instrument during the update process.*

NOTE. *The screen images of the following procedure are provided as an example. The actual screen display may be different depending on your instrument configuration.*

1. Push the front-panel Utility button to display the Utility menu and view the currently installed firmware version located at the bottom of the display screen.

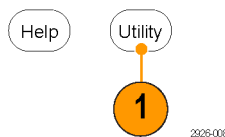

2. From a PC, visit www.tektronix.com and check if Tektronix offers a newer firmware version. Download and unzip the compressed zip file with the most current firmware to a USB memory device.



3. Insert the USB memory device into the front-panel USB connector on your instrument.

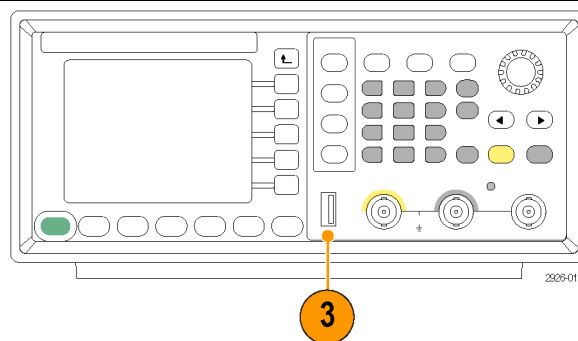

4. Push the -more- bezel button twice in the Utility menu.

5. Select Firmware Update.

NOTE. If the USB memory device is not inserted, the Firmware Update bezel button is disabled.

NOTE. If Access Protection is on, the Firmware Update bezel button is disabled.

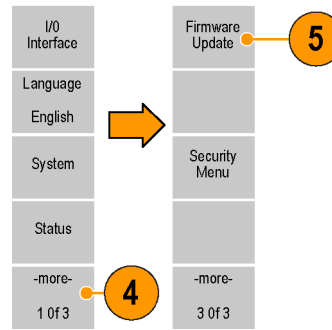

6. Select the downloaded firmware file by rotating the general purpose knob, and then push the Execute bezel button.

NOTE. The firmware file name is as follows: `tekafgtb-1.x.x.tfb`

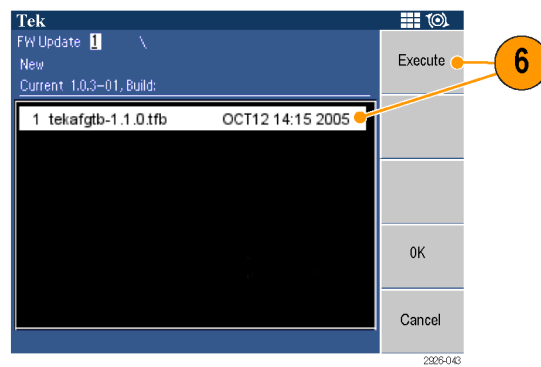

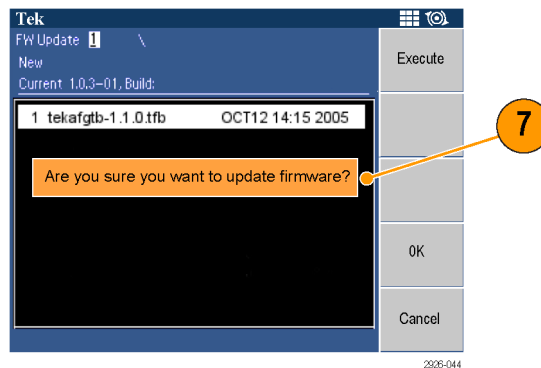

7. The instrument asks you "Are you sure you want to update firmware?". Select OK.

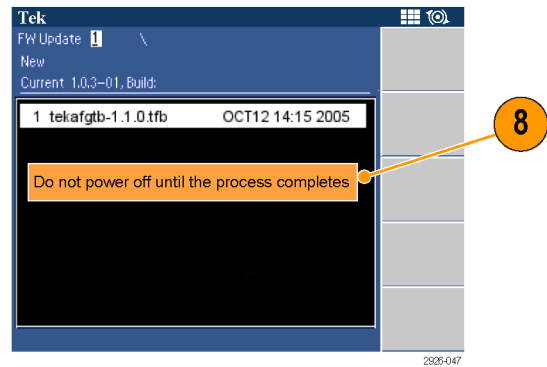

- The instrument displays a message telling you not to remove the USB device or power off the instrument until the update process is complete. The clock symbol at the top right of the screen indicates the update process is in progress.



 **CAUTION.** A firmware update usually takes approximately two minutes. Do not remove the USB memory during the update process.

 **CAUTION.** If you accidentally removed the USB memory during the update process, do not power off the instrument. Repeat the installation process from step 3.

- Wait until the instrument displays a message saying that the operation is complete.

- Push OK.

 **CAUTION.** If the operation complete message is not displayed, do not power off the instrument. Repeat the installation process from step 2 using a different type of USB memory device.

11. Remove the USB memory device from the front-panel USB connector.
12. Power the instrument off and then back on for the firmware to take effect.

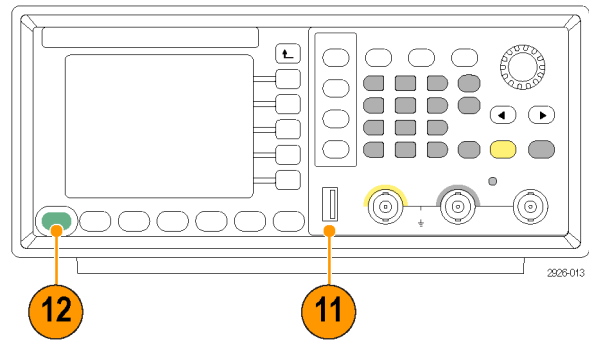

13. Push the front-panel Utility button to display the Utility menu.
Confirm that the firmware has been updated.

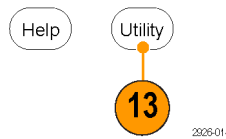

NOTE. You can protect access to firmware update using the Security menu.

Connect to a network

The instrument communication interface allows you to communicate with or remotely control your instrument. Depending on the instrument model, you can use a USB, Ethernet, or GPIB interface.

NOTE. The AFG2021 with option GL provides USB, GPIB, and LAN ports. The AFG2021 base model provides a USB port only.

USB interface

The USB interface on the rear panel requires no front panel or bezel menu operations to set up. Use a USB cable to connect your instrument to a PC.

Ethernet setup

NOTE. Ethernet setup is only available with the AFG2021 with option GL, which has a LAN port.

To connect your instrument to a network, you must first obtain information from your network administrator. The procedure for entering the Ethernet network parameters depends on your network configuration. If your network supports DHCP (Dynamic Host Configuration Protocol), follow these steps:

1. Connect a LAN cable to the LAN port on the rear panel.

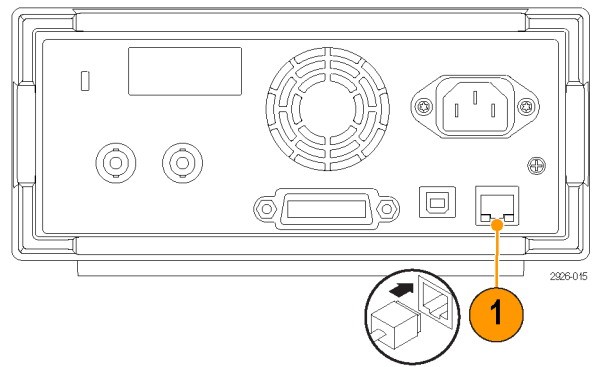

2. Push the front-panel Utility button.



3. Push the I/O Interface bezel button, and then the Ethernet bezel button.

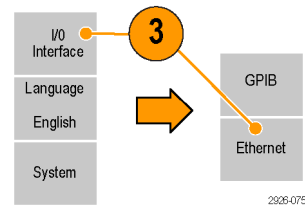

4. Select Off or On for the DHCP when the Ethernet Network Settings menu is displayed.

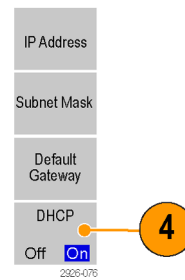

NOTE. By selecting *DHCP On*, the instrument can set its network address automatically through *DHCP*.

If you cannot establish communication by setting DHCP On, you need to set up an IP Address manually and a Subnet Mask if necessary. To do this, follow these steps:

5. Display the Ethernet Network Settings menu and select DHCP Off.
6. Push the IP Address bezel button to enter an IP address. You need to contact your network administrator to get the IP address to use.
7. Push the Subnet Mask bezel button to enter a Subnet Mask. Ask your network administrator whether a subnet mask is required.
8. Push the Default Gateway bezel button to enter a gateway address. Ask your network administrator for the gateway address.

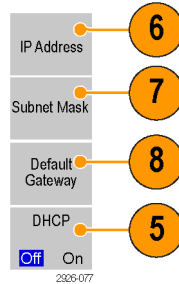

GPIB setup

NOTE. GPIB setup is only available with the AFG2021 with option GL, which has a GPIB port.

To set the instrument GPIB interface, follow these steps:

1. Connect a GPIB cable to the rear panel GPIB port.

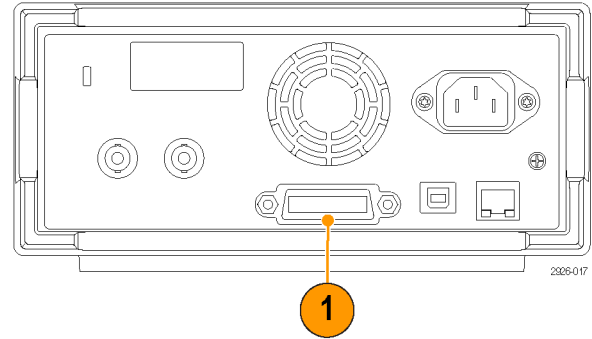

2. Push the front-panel Utility button.



3. Push the I/O Interface bezel button and then the GPIB bezel button.

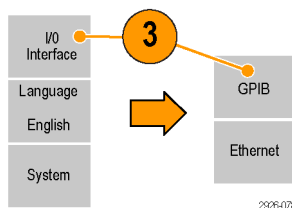

4. Push the Address bezel button to assign a unique address to the instrument. The GPIB address defines a unique address for the instrument. Each device connected to the GPIB bus must have a unique GPIB address. The GPIB address must be from 0 to 30.

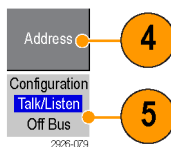

5. Push the Configuration bezel button to toggle the instrument bus communications on and off.
- Talk/Listen - Select this mode to remotely control the instrument from an external host computer.
 - Off Bus - Select this mode to disconnect the instrument from the GPIB bus.

NOTE. Refer to the AFG2021 Arbitrary/Function Generator Programmer Manual for information about remote control commands.

Equivalent output circuits

The following illustrations show the equivalent output circuits:

Legend for the following images:

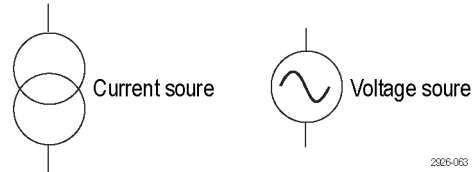

- Output signals do not exceed ± 10 V when the $>50 \Omega$ load impedance is used.

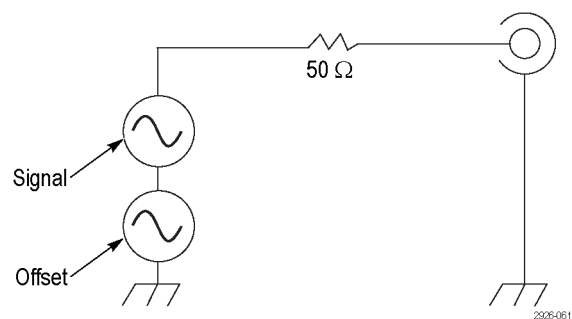

- Amplitude and offset are affected when you change the load impedance. The maximum and minimum levels do not exceed ± 10 V, respectively.

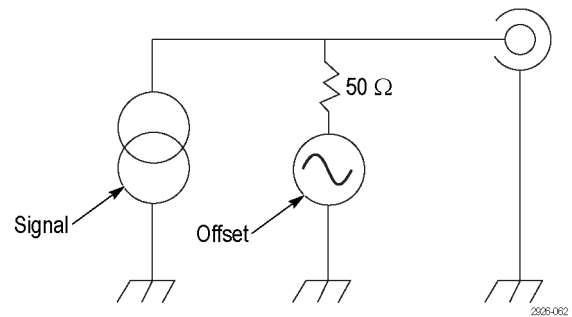

A change to the load impedance (L) will affect the output window (maximum and minimum levels) for a sine waveform as follows.

- **L = 50Ω** : -5 V to +5 V (10 Vp-p)
- **L = High Z**: -10 V to +10 V (20 Vp-p)

Instrument front panel, interface, and rear panel

Front panel overview

The front panel is divided into easy-to-use functional areas. This section provides you with a quick overview of the front panel controls and the screen interface.

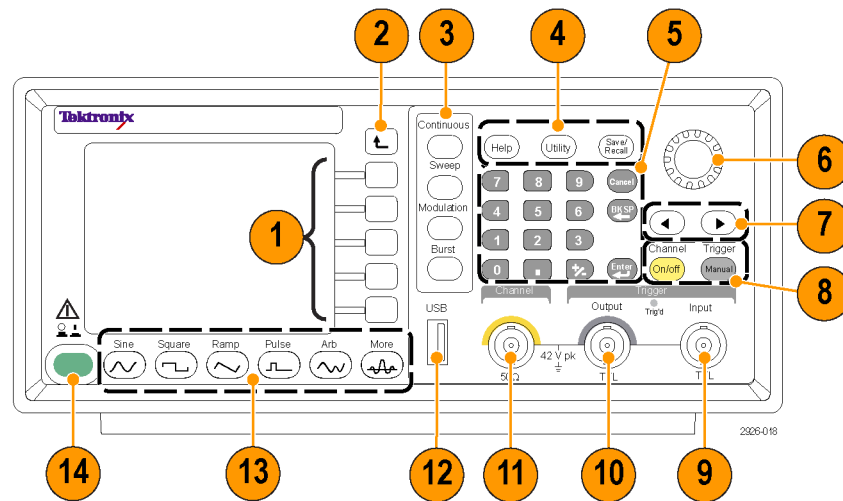

| Item | Description |
|------|---|
| 1 | Bezel buttons |
| 2 | Return to previous menu |
| 3 | Run mode buttons |
| 4 | Help, Utility, and Save/Recall buttons |
| 5 | Numeric keypad, cancel action, delete/backspace, and Enter buttons |
| 6 | General purpose knob |
| 7 | Arrow buttons allow you to select a specific number on the display screen when you are changing amplitude, phase, frequency, or other such values |
| 8 | Channel On/Off and Manual Trigger buttons |
| 9 | Trigger input connector |
| 10 | Trigger output connector |
| 11 | Channel output connector |
| 12 | USB connector |
| 13 | Function buttons |
| 14 | Power button |

Lock or unlock the front panel controls

If you need to lock the front panel controls, use the following remote command:

- `SYSTem:KLOCK[:STATe]`

To unlock the front panel without using a remote command, push the front-panel Cancel button twice.

Parts of the screen interface

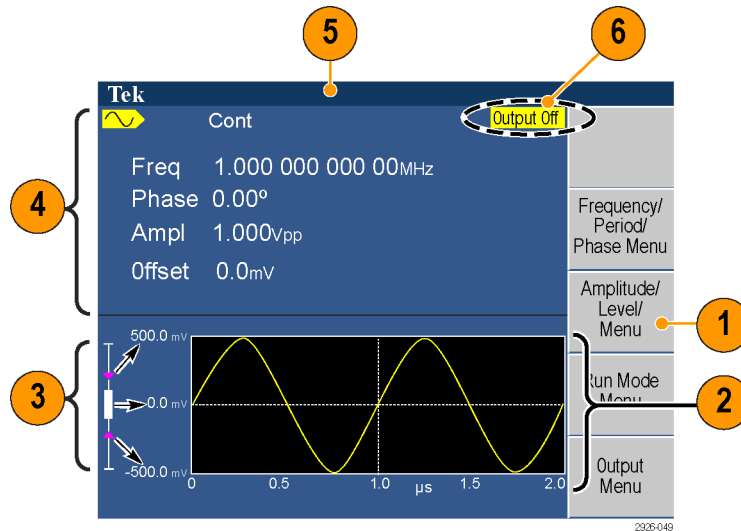

| Item | Description |
|------|--|
| 1 | Bezel menu: When you push a front panel button, the instrument displays the corresponding menu on the right side of the screen. The menu shows the options that are available when you push the unlabeled bezel buttons directly to the right of the screen. (Some documentation may also refer to the bezel buttons as option buttons, side-menu buttons, or soft keys.) |
| 2 | Graph / waveform display area: This part of the main display area shows the signal as a graph or waveform. |
| 3 | Level meter: The top portion of the indicator shows the high limit value; the bottom portion of the indicator shows the low limit value; and the indicator itself shows the currently selected level. |
| 4 | Parameter display area: This part of the main display area shows active parameters. |
| 5 | Message display area: A message that monitors hardware status such as clock or trigger is displayed in this area. |
| 6 | Output status: If the output is set to disable, Output Off message is displayed in this area. When you push the front panel channel output button to enable the output, the message will disappear. |

Default setup

When you want to restore the instrument settings to the default values, use the front-panel Save/Recall button as follows:

1. Push the front-panel Save/Recall button.



2. Push the Setup bezel button to select Recall.
3. Push the Default bezel button.

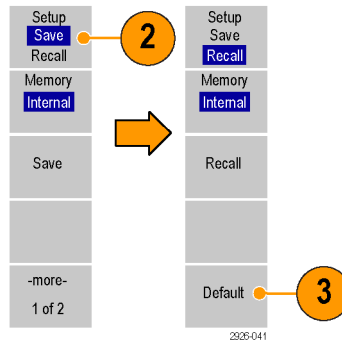

4. Select one of the following:

- **OK** to recall the default settings; the instrument will display a 1 MHz frequency, 1 Vp-p amplitude sine waveform as the default setup.
- **Cancel** to cancel the recall and return to the previous menu.

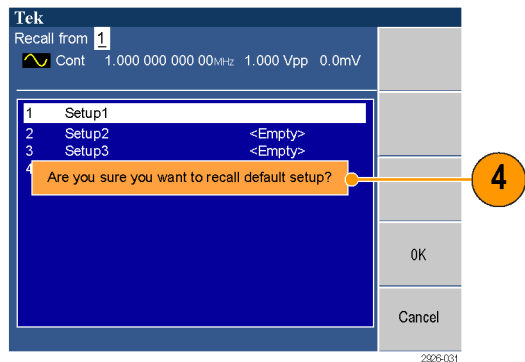

Default settings

Default settings

| Menu/System | Default setting |
|-----------------------------|--|
| Output configuration | |
| Function | Sine |
| Frequency | 1.000 000 000 00 MHz |
| Amplitude | 1.000 Vp-p |
| Offset | 0 mV |
| Symmetry (ramp) | 50.00% |
| Duty (Pulse) | 50.00% |
| Output Units | Vp-p |
| Output impedance | 50 Ω |
| Output invert | Off |
| Output noise add | Off |
| Sweep | |
| Sweep start frequency | 100.000 kHz |
| Sweep stop frequency | 100.000 MHz |
| Sweep time | 10 ms |
| Sweep hold time | 0 ms |
| Sweep return time | 1 ms |
| Sweep type | Linear |
| Sweep mode | Repeat |
| Sweep source | Internal |
| Trigger slope | Positive |
| Trigger interval | 1.000 ms |
| Modulation | |
| Modulation waveform | 10.00 kHz, Sine (except FSK) 50.00 Hz, Square (FSK) |
| AM depth | 50.00% |
| FM deviation | 1.000 000 MHz |
| PM deviation | 90.0° |
| FSK hop frequency | 1.000 000 MHz |
| FSK rate | 50.00 Hz |
| PWM deviation | 5.00% |
| Burst | |
| Burst mode | N-Cycles |
| Burst count | 5 |
| Trigger source | Internal |
| Trigger delay | 0.0 ns |
| Trigger interval | 1.000 ms |

| Menu/System | Default setting |
|--------------------------------|-----------------|
| System related settings | |
| Trigger out | Trigger |
| Clock reference | Internal |

The Default bezel button in the Save/Recall menu does not reset the following settings:

- Language option
- Power-on settings
- System related settings (display brightness, screen saver, click tone, and beeper)
- Saved setup and waveform files
- Calibration data
- GPIB and Ethernet setups
- Access protection

Select waveform

The instrument can provide 12 standard waveforms (Sine, Square, Ramp, Pulse, Sin(x)/x, Noise, DC, Gaussian, Lorentz, Exponential Rise, Exponential Decay, and Haversine). The instrument can also provide user-defined arbitrary waveforms. You can create, edit, and save your custom waveforms.

You can also create modulated waveforms using the Run Mode Modulation menus. The following table shows the combination of modulation type and the shape of the output waveform.

| | Sine, Square, Ramp, Arb, Sin(x)/x, Gaussian, Lorentz, Exponential Rise, Exponential Decay, Haversine | Pulse | Noise, DC |
|-----|--|-------|--------------|
| AM | √ | | |
| FM | √ | | |
| PM | √ | | |
| FSK | √ | | |
| PWM | | √ | |

| | Sine, Square, Ramp, Arb, Sin(x)/x, Gaussian, Lorentz, Exponential Rise, Exponential Decay, Haversine | Pulse | Noise, DC |
|-------|--|-------|--------------|
| Sweep | √ | | |
| Burst | √ | √ | |

NOTE. When the instrument outputs an Arb waveform, V_{p-p} of instrument setup indicates the V_{p-p} value of normalized waveform data.

When the instrument outputs Sin(x)/x, Gaussian, Lorentz, Exponential Rise, Exponential Decay, or Haversine, V_{p-p} is defined as twice the value of 0 to peak value.

To select an output waveform, follow these steps:

1. Push the front-panel Sine button to select sine waveform.
2. Push the front-panel Continuous button to select a continuous sine waveform.
3. Select one of the four standard waveforms by pushing on of the front-panel function buttons.
4. Push the Arb button to select an arbitrary waveform.
5. Push the More Waveform bezel button to select from other standard waveforms such as Sin(x)/x, Noise, DC, or Gaussian.

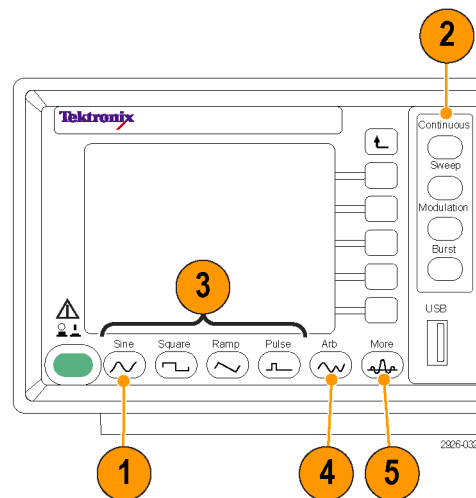

Other available waveforms

The following are examples of the other waveform types available in the More Waveform menu under the More button menu.

Sin(x)/x

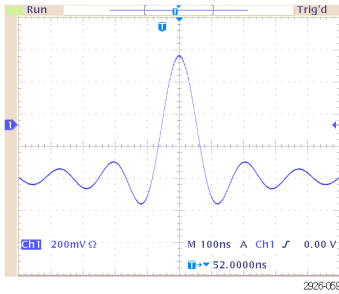

Noise

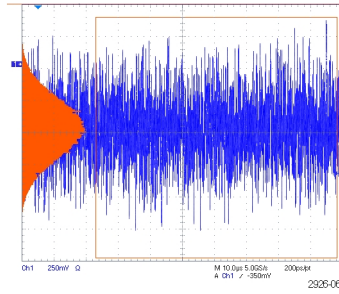

DC

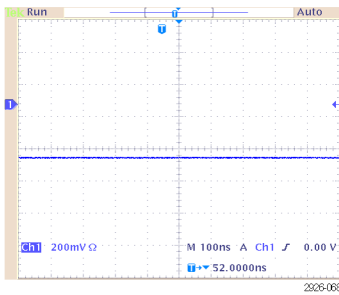

Gaussian

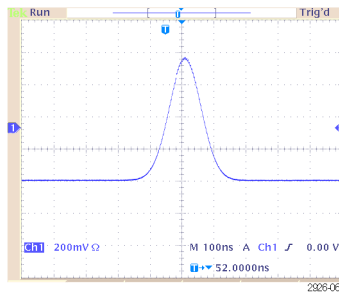

Lorentz

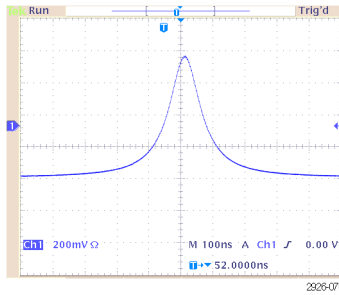

Haversine

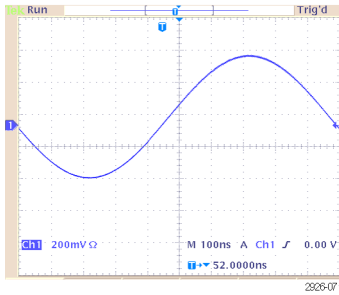

Exponential Rise

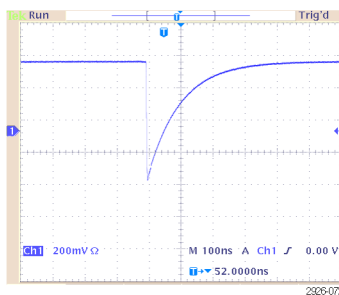

Exponential Decay

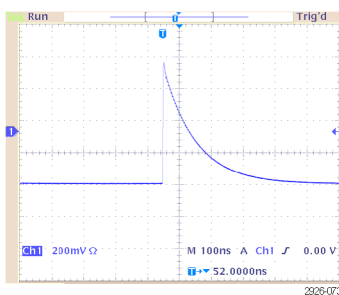

Select run mode

Push one of the four Run Mode buttons to select the instrument signal output method.

1. The default Run Mode is Continuous.

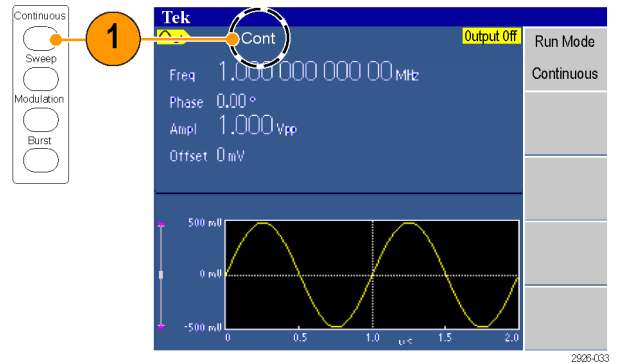

2. To select a modulated waveform, push the Modulation button.

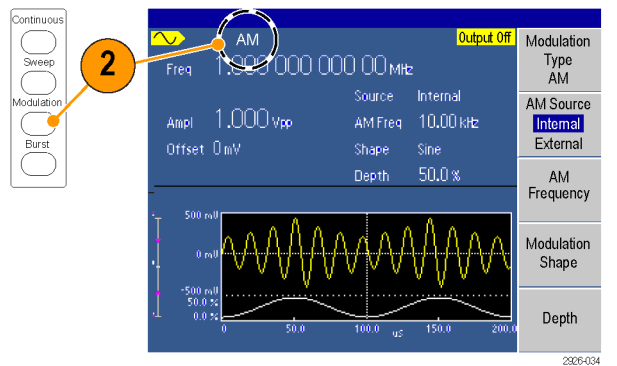

- To select a sweep waveform, push the Sweep button. See (See page 50.) for details on sweeping waveforms.

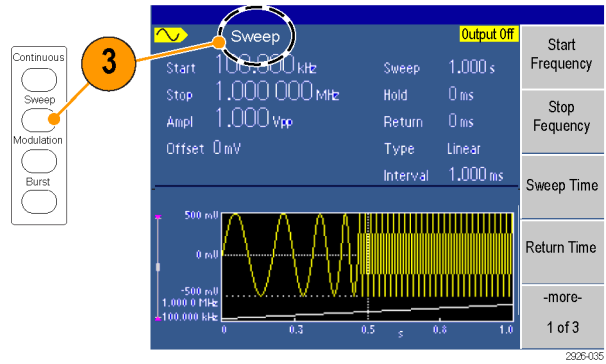

- To select a burst waveform, push the Burst button.

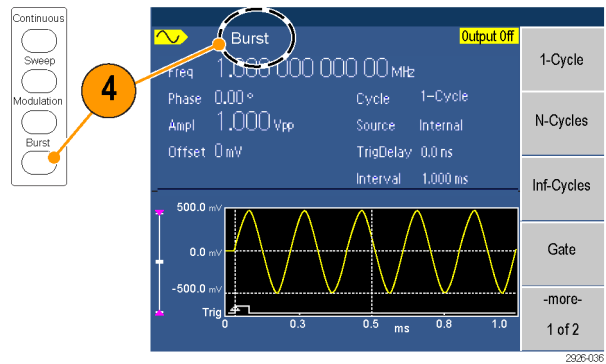

Adjust waveform parameters

When you turn on your instrument, the default output signal is a 1 MHz sine waveform with an amplitude of 1 Vp-p. In the following example, you can change the frequency and amplitude of the original output signal.

- Push the front-panel Save/Recall button.



- Push the Setup bezel button to select Recall.

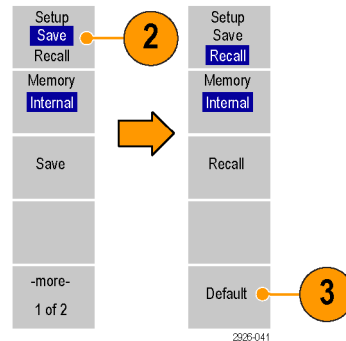

- Push the Default bezel button and then push the OK bezel button to display the default output signal.

- To change frequency, push the front-panel Frequency/Period/Phase Menu bezel button.

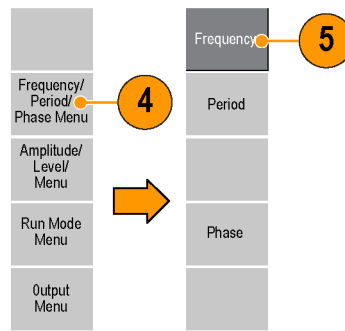

- Press the Frequency bezel button.

- Use the numeric keypad or the general purpose knob to set the frequency value.

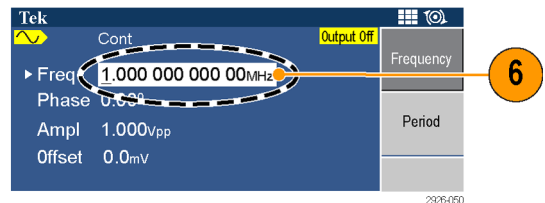

- To change period, push the Period bezel button to select the Period parameter.

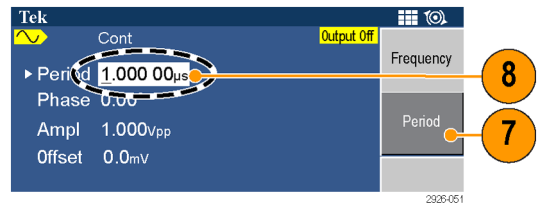

- Use the numeric keypad or the general purpose knob to set the period value.

- To change the amplitude, first push the



front-panel button to return to the top menu, and then press the Amplitude/Level Menu bezel button.

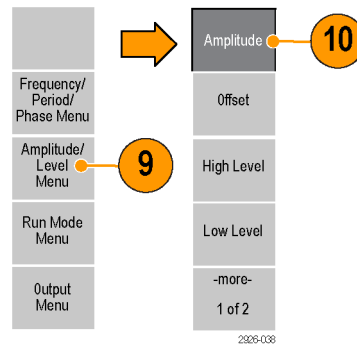

- Press the Amplitude bezel button.

- Use the numeric keypad or the general purpose knob to set the amplitude value.

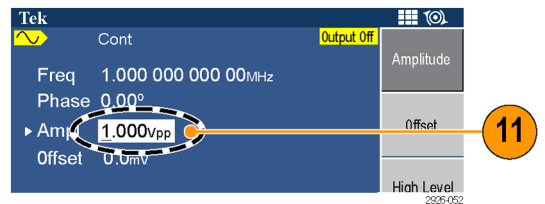

12. To change the amplitude units, push the -more- bezel button to display the second page of the menu.
13. Push the Units bezel button to display units selection bezel menu and make your selection. By default, Vpp is selected.

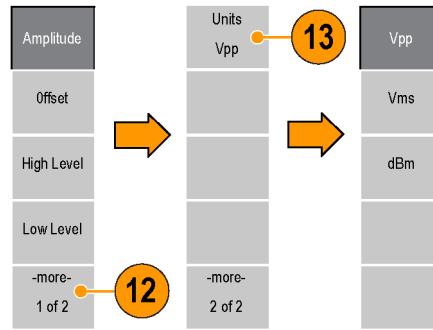

14. Push the High or Low Level bezel button to select that parameter.
15. Use the numeric keypad or the general purpose knob to set the value. You can change the values of Phase and Offset in the same way.

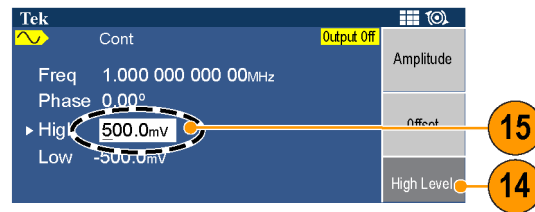

Unit conversions

The following conversion table shows the relationship between Vp-p, Vrms, and dBm.

| V _{p-p} | V _{rms} | dBm |
|------------------|------------------|------------|
| 10.00 Vp-p | 3.54 Vrms | +23.98 dBm |
| 2.828 Vp-p | 1.00 Vrms | +13.01 dBm |
| 2.000 Vp-p | 707 mVrms | +10.00 dBm |
| 1.414 Vp-p | 500 mVrms | +6.99 dBm |
| 632 mVp-p | 224 mVrms | 0.00 dBm |
| 283 mVp-p | 100 mVrms | -6.99 dBm |
| 200 mVp-p | 70.7 mVrms | -10.00 dBm |
| 10.0 mVp-p | 3.54 mVrms | -36.02 dBm |

Channel output On/Off

- To enable signal output, push the front-panel Channel On/Off. The button is lit with an LED when it is in the On state. You can configure the signal with the outputs off. This will allow you to minimize the chance of sending a problematic signal to a DUT.



Rear panel

The following illustration shows the rear panel connectors for the instrument.

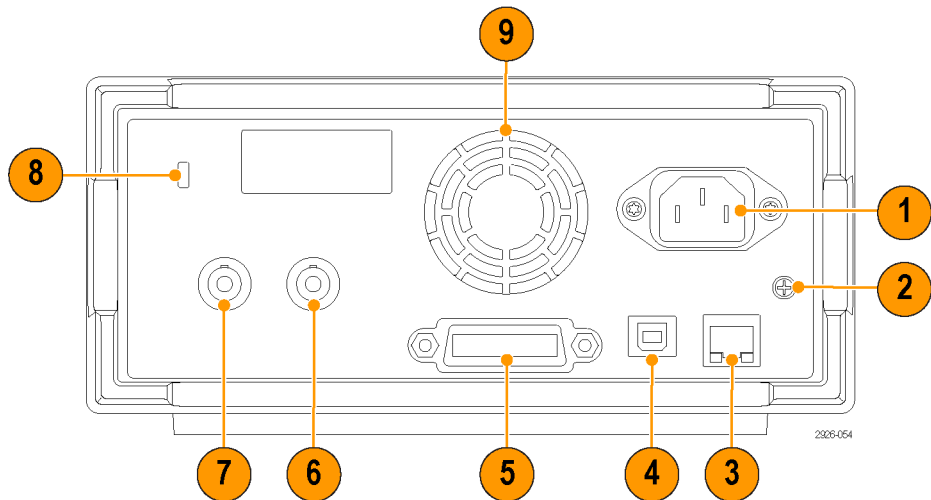

| Item | Description |
|------|--|
| 1 | Power input: This is where you attached an appropriate power cord to supply power to the instrument. |
| 2 | Chassis ground screw: This screw is used to ground the instrument. Use a unified coarse screw (#6-32, 6.35 mm length or less). |
| 3 | LAN port: This port can be used to connect the instrument to a network. Connect a 10BASE-T or 100BASE-T cable here. NOTE. This port is only available for the AFG2021 with option GL. |
| 4 | USB (type B) connector: This can be used to connect a USB type B controller. |
| 5 | GPIB: This is port can be used to control the instrument through GPIB commands. NOTE. This port is only available for the AFG2021 with option GL. |

| Item | Description |
|-------------|--|
| 6 | EXT REF INPUT connector: This is a BNC connector for the external reference input. |
| 7 | EXT MODULATION INPUT connector: This is a BNC connector for the external modulation input. It can be used to input a modulated signals. |
| 8 | Security slot: This slot allows you to use a standard laptop computer security cable to secure your instrument to your location. |
| 9 | Fan (ventilation) vent: This is the ventilation opening for the fan. |

Operating basics

Quick tutorial: How to select a waveform and adjust parameters

If you are a beginning user, you can follow the steps described here to get acquainted with how to select a waveform and adjust waveform parameters.

1. Press the power button to on the instrument.
2. Connect the Channel Output of the instrument to the oscilloscope input with a BNC cable.
3. Select a waveform.
4. Enable the signal output.
5. Observe a waveform displayed on the oscilloscope screen.
6. Use the front-panel shortcut buttons on the instrument to select a waveform parameter.
7. Select Frequency as a parameter to be changed.
8. Change the frequency value using the numeric keys.
9. Change the waveform parameters using the general purpose knob and the arrow keys.

Quick tutorial: How to generate a sine waveform

If you are a beginning user, you can follow the steps described here to learn how to generate a continuous sine waveform.

1. Connect the power cord, and then push the front-panel power button to turn on the instrument.
2. Connect a BNC cable from the Channel Output of the arbitrary/function generator to an oscilloscope input connector.

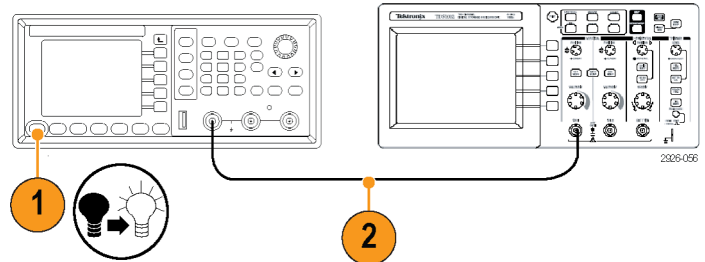

3. Push the front-panel Sine button.
4. Push the front-panel Continuous button to select a continuous sine waveform.

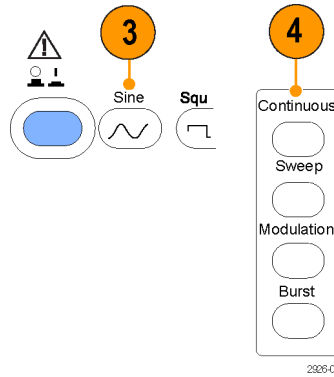

5. Push the front-panel Channel On/Off button to enable the output. The button should be lit.



6. Use the oscilloscope auto-scaling function to display the sine waveform on the screen.

If the instrument outputs a default sine waveform, you can manually set the oscilloscope as follows:

- 500 ns/div
- 200 mV/div

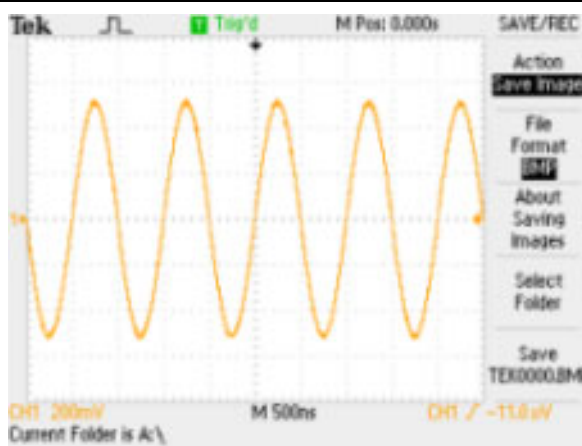

7. To change the frequency, push the front-panel Sine button and then push the Frequency/Period/Phase Menu bezel button.

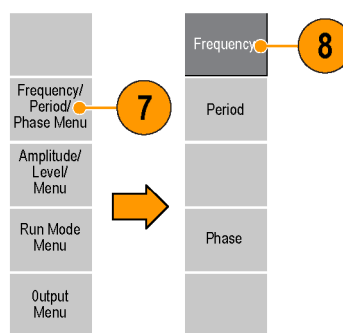

8. Push the Frequency bezel button. You can now change the frequency value using the numeric keypad or the general knob.

For example, if you enter a value "2" using the keypad, the bezel menu will automatically change to Units.

After entering the frequency value, push the Units bezel button or the front-panel Enter button to complete the entry.

You can change the Amplitude, Phase, and Offset values in the same way.

NOTE. When you specify a waveform parameter using the bezel menu selection, an active parameter is displayed in green in the graph area.

Quick tutorial: Instrument help system

The instrument help system allows you to access information about specific menu items and instrument functions when you need help. You can access and navigate this help system using front panel buttons and knobs, and following on-screen instructions as they appear. The individual help topics may contain links to other topics, as well. These can be accessed by following the on-screen instructions.

How to access the instrument help system

You can follow the steps described here to access the instrument help system.

1. Push the front-panel Help button to display the help screen.
2. Turn the general purpose knob to move the highlight from one link to another.
3. Push the Show Topic bezel button to display the topic corresponding to the highlighted link.
4. Push the Index bezel button to display an Index page.
5. Push the Exit bezel button or any front-panel button to remove the Help text from the screen and return to the graphic or parameter display.

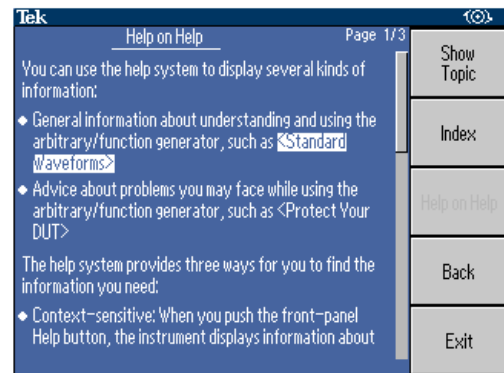

Ways to access and navigate the instrument help system

- Push the Help button to display information (topic) about the last menu displayed on the screen.
- Turn the general purpose knob to move from page to page within a displayed topic.
- Push the Index bezel button to view the Help index page.
- Push the Page Up or Page Down bezel buttons to search for the index page that contains the topic you want to view.
- Turn the general purpose knob to highlight a help topic in the index.
- Push the Show Topic bezel button to display the topic from the index page.
- Push the Utility button and then the Language bezel button to choose the language in which you want the Help topics, bezel menus, and on-screen messages to appear.

Operating Basics

Generate a pulse waveform

1. Push the front-panel Pulse button to display the Pulse screen.
2. Push the Pulse Parameter Menu bezel button.

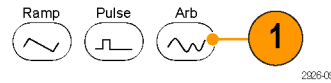

NOTE. All of the following parameters can be adjusted using the numeric keypad or the general knob.

3. Push the Duty bezel button and adjust the parameter as needed, and then push the Width bezel button and adjust the parameter as needed.
4. Push the Leading Edge bezel button and adjust the parameter as needed, then push the Trailing Edge bezel button and adjust the parameter as needed.

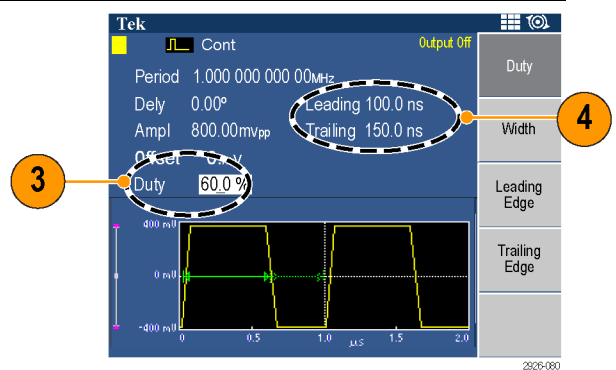

5. You can set the lead delay by pushing the



front-panel button, and then pushing the Frequency/Period/Delay Menu and adjusting the parameter as needed.

Pulse waveform formulas

The following formulas are applied to leading edge time, trailing edge time, pulse period, and pulse width of pulse waveforms.

$lEdge$ (Leading Edge Time)

$tEdge$ (Trailing Edge Time)

Maximum leading edge time. This value is the minimum of the three in each instance.

If runMode = Continuous:

$$\text{Temp1} = 0.8 * 2.0 * \text{width} - \text{tEdge};$$

$$\text{Temp2} = (\text{period} - \text{width}) * 0.8 * 2.0 - \text{tEdge};$$

$$\text{Temp3} = 0.625 * \text{period}.$$

Else:

$$\text{Temp1} = 0.8 * 2.0 * \text{width} - \text{tEdge};$$

$$\text{Temp2} = (\text{period} - \text{leadDelay} - \text{width}) * 0.8 * 2.0 - \text{tEdge};$$

$$\text{Temp3} = 0.625 * \text{period}.$$

Maximum trailing edge time. This value is the minimum of the three in each instance.

If runMode = Continuous:

$$\text{Temp1} = 0.8 * 2.0 * \text{width} - \text{lEdge};$$

$$\text{Temp2} = (\text{period} - \text{width}) * 0.8 * 2.0 - \text{lEdge};$$

$$\text{Temp3} = 0.625 * \text{period}.$$

Else:

$$\text{Temp1} = 0.8 * 2.0 * \text{width} - \text{lEdge};$$

$$\text{Temp2} = (\text{period} - \text{leadDelay} - \text{width}) * 0.8 * 2.0 - \text{lEdge};$$

$$\text{Temp3} = 0.625 * \text{period}.$$

Save/recall instrument setups

You can save up to instrument setups in the instrument internal memory. To save more setups, use a USB memory device.

1. To recall or save an arbitrary waveform, push the front-panel Save/Recall button.
2. Use the general purpose knob to highlight a setup that is marked <empty>, unless you want to overwrite an existing setup.



NOTE. To protect a setup file from accidental overwrite, push the -more- bezel button and then push the Lock/Unlock bezel button. A lock icon will appear next to locked files.

3. Push the Save bezel button to save the setup to internal memory.
4. If you want to save a setup to USB memory, you must first insert a USB memory device into the port, select Memory USB from the bezel menu, and then push Save.
A file with the extension TFS is saved. You can name the files.

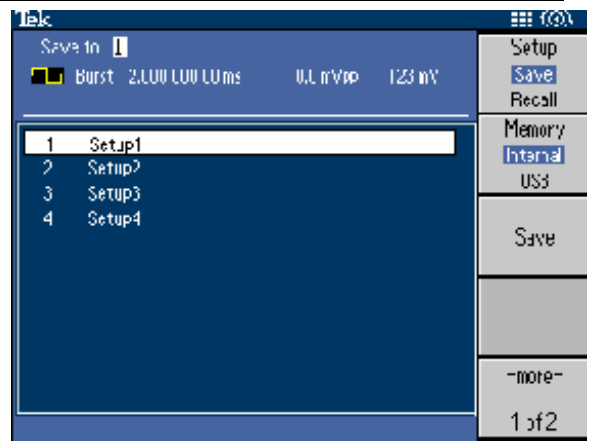

5. You can also recall waveforms by selecting Setup Recall from the bezel menu, and then select the setup you want to recall using the general knob.
6. Push the Recall bezel button.

NOTE. If you want to delete a setup from memory, push the -more- bezel button and then push the Erase bezel button and confirm your selection by pushing OK.



Generate an arbitrary waveform

The instrument can output an arbitrary waveform that is stored in the internal memory or a USB memory.

NOTE. File names are displayed only in English characters. If you use non-English characters to name a file, these characters are replaced by symbols such as #, \$, %.

1. Push the front-panel Arb button.

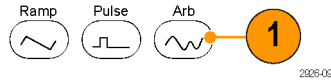

2. Push the Arb Waveform Menu bezel button.

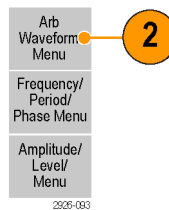

3. The Arb Waveform Menu is displayed. You can now browse a list of waveform files in the internal memory or USB memory.

Select Internal. You can specify a file from User 1 through User 4, or Edit Memory.

Use the front panel general purpose knob to scroll the files, then select a file and push OK.

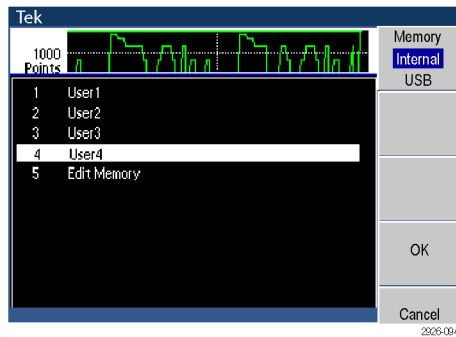

4. When USB is selected, the instrument lists a directory of the folders and files on the USB memory.

You can select a folder or file using the knob to scroll up and down the list. To open a folder, push the Change Directory bezel button. To open a file, push OK.

To return to the upper directory, first select the <Up Directory> icon, and then push the Change Directory bezel button.

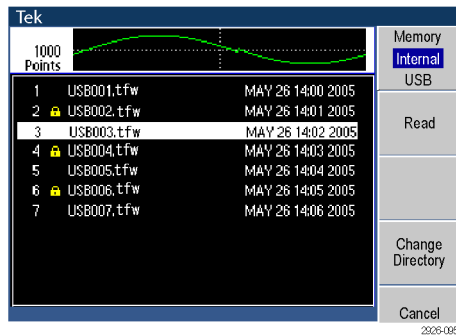

Modify an arbitrary waveform

To modify an arbitrary waveform, use the Edit bezel button in the Arbitrary Waveform Menu. The Edit bezel button supports several waveform edit functions, and provides import or storage of edited waveform data.

1. Push the Arb button.

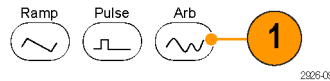

2. Push the Arb Waveform Menu bezel button, and then push the Edit bezel button.

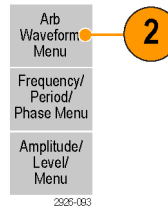

3. Select Number of Points to set the number of waveform points to be edited.
4. Select New to write a standard waveform to Edit memory. The written waveform has the number of points specified by Number of Points. One of five waveform types (Sine, Square, Pulse, Ramp, and Noise) can be selected.
5. Select Operation to display the Operations submenu.
6. Select Read from... to write a standard waveform to Edit memory. The written waveform has the number of points specified in the Number of Points menu. One of five waveform types (Sine, Square, Ramp, Pulse, and Noise) can be selected.



NOTE. Push the *-more-* bezel button to see the *Read from...* menu item.

7. Push Operation to display the Operations submenu.

- Push Line to display the Line edit submenu.
- Push Data to display the Data Point edit submenu.
- Push Cut to display the Cut Data Points submenu.

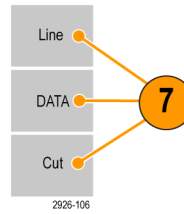

8. Select Paste at Beginning to append a waveform at the beginning of the edit waveform.

Select Paste at End to append a waveform at the end of the edit waveform.

9. Select Write to... to display a submenu to write waveform data to.

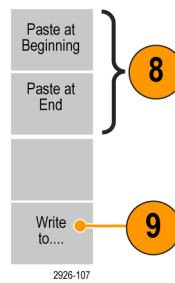

Arbitrary waveform edit example 1

The following example shows how to use the Line edit function. Paste a ramp waveform before sine waveform:

1. Select Number of Points and use the numeric keypad or the general knob to set the number of waveform points to 1000.
2. Select New and then select Sine. Save this waveform to User1.

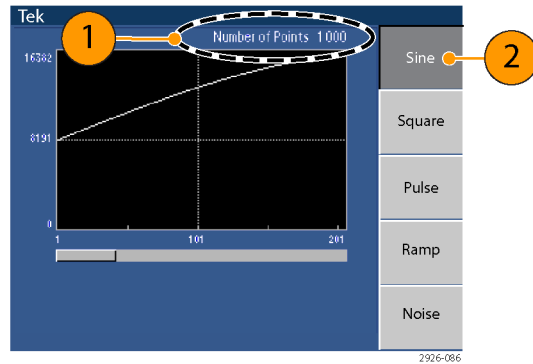

3. Next, create a 500 point ramp waveform.
4. Select Operation and select Line. Do the following line edit:

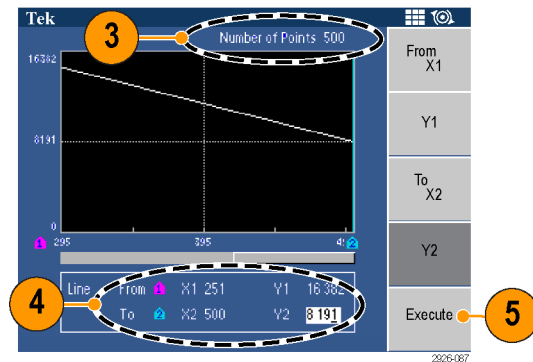

- X1: 1, Y1: 8191
- X2: 250, Y2: 16382

Push Execute. Once again, select Line from Operation and perform the following line edit:

- X1: 251, Y1: 16382
- X2: 500, Y2: 8191

5. Push Execute. Save this waveform to User2.

6. Next, paste a waveform. Push Read from... and select User1.
7. Push Paste at Beginning. Select User2 waveform and then select Paste.

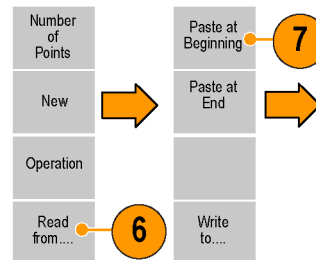

8. The waveform shown here is created.

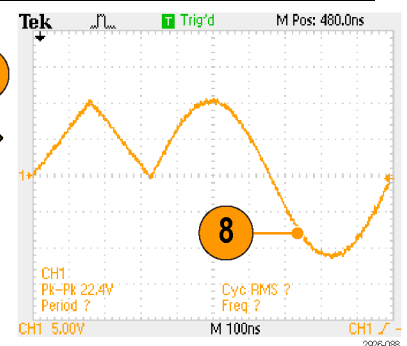

Arbitrary waveform edit example 2

The following example shows how to edit a waveform by data point. In this example, you can add a noise spike to the sine waveform.

1. Push Read from... and select User1.
2. Push the Read bezel button and change the screen to a table display.

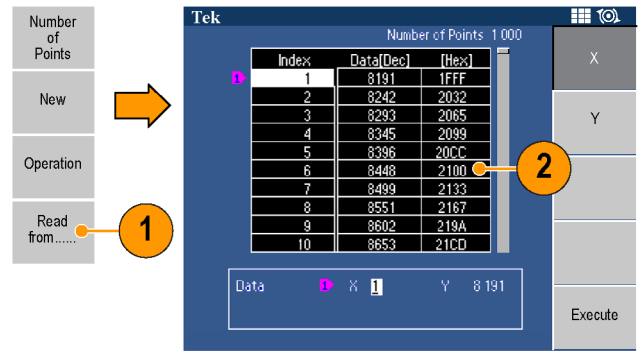

3. Push Operation and select Data.
4. Perform the following data point edit:

- X: 250, Y: 8191
- X: 251, Y: 8191
- X: 750, Y: 8191
- X: 751, Y: 8191

5. After each data edit, push Execute to implement the edit operation. Save this waveform to User3.

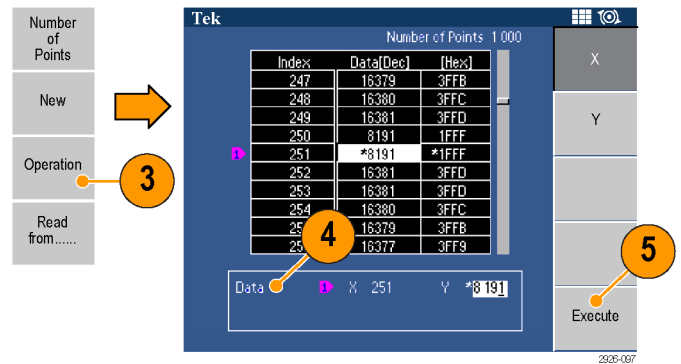

6. This is an example of an oscilloscope screen for the User3 waveform.

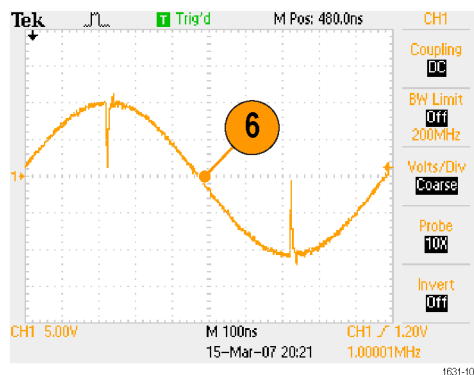

NOTE. If you edit an arbitrary waveform data while the instrument generates a waveform from Edit Memory, the edited data will be automatically reflected to the generated waveform.

Generate noise/DC

1. Push the front-panel More waveform button.



2. Push the More Waveform Menu bezel button.

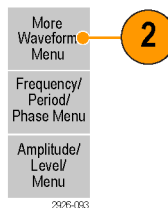

3. Select Noise.
4. You can set waveform parameters for Noise. This is a sample of Gaussian Noise displayed on an oscilloscope screen.

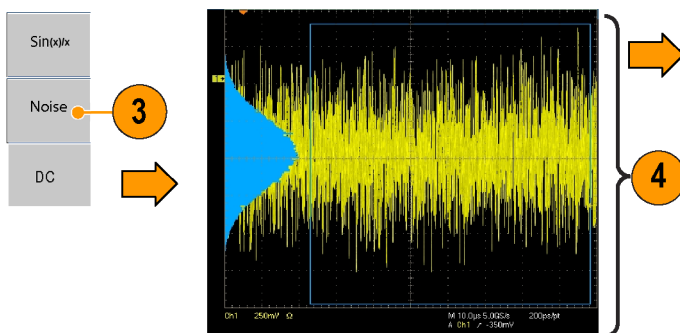

5. Push DC to display DC parameters.

NOTE. You cannot modulate, sweep, or burst noise or a DC waveform.

Generate a burst waveform

The instrument can output a burst using standard waveforms such as sine, square, ramp, and pulse, or arbitrary waveforms. The instrument allows you to use the following two types of burst modes:

Triggered burst mode. A specified number (burst count) of waveform cycles are output when the instrument receives a trigger input from the internal trigger source, an external trigger source, a remote command, or the Manual Trigger button.

Gated burst mode. The instrument outputs a continuous waveform when an effective gate signal is applied externally, when the Manual Trigger button is depressed, when a remote command is applied, or during 50% of the selected internal trigger interval.

To generate a triggered burst waveform

The instrument provides the following three trigger sources for Burst mode:

- Internal or external trigger signal
- Manual trigger
- Remote command

The following example describes how to generate a double pulse using the burst mode.

1. Select Pulse as an output waveform and then push the front-panel Burst button.
2. Confirm that 1-Cycle, N-Cycles, or Inf-Cycles is selected, which means triggered burst mode is enabled.
To generate double pulse, set the burst count (N-Cycles) to 2 by pushing the N-Cycles bezel button and then pushing the 2 button.

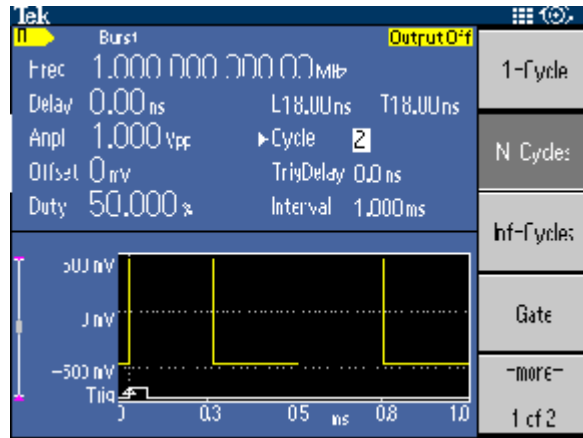

3. This is an example of double pulse.
4. This waveform is a trigger output signal.

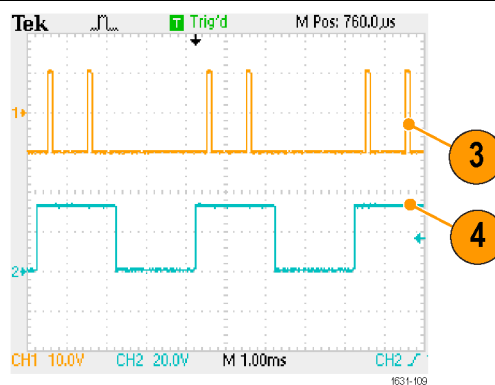

To generate a gated burst waveform

In the gated burst mode, the output is enabled or disabled based on the internal gate signal or an external signal applied to the front-panel Trigger Input connector. While the gate signal is true or the front-panel Manual Trigger button is pushed in, the instrument outputs a continuous waveform.

NOTE. Once Gate is selected, burst count parameters are ignored.

1. Push the front-panel Burst button to display the burst menu.
2. Select Gate.

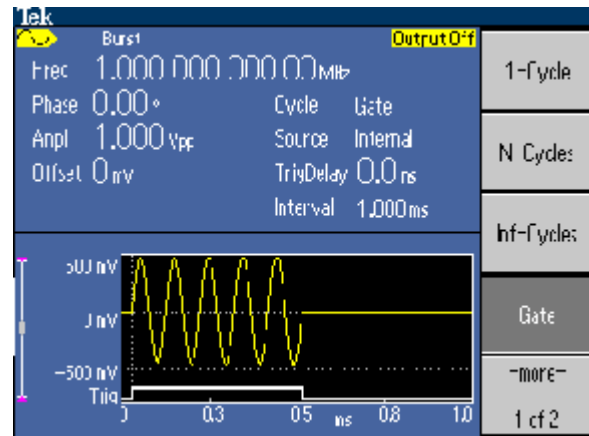

3. This is a sample oscilloscope screen. The top waveform is a trigger output signal.
4. This is a gated waveform sample.

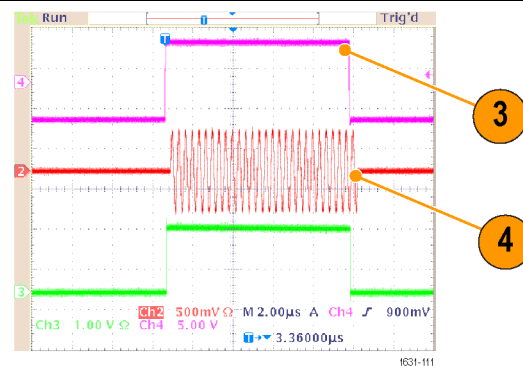

Sweep a waveform

The Sweep outputs a waveform with the output signal frequency varying linearly or logarithmically.

- Stop frequency
- Sweep time
- Return time
- Center frequency
- Frequency span
- Hold time

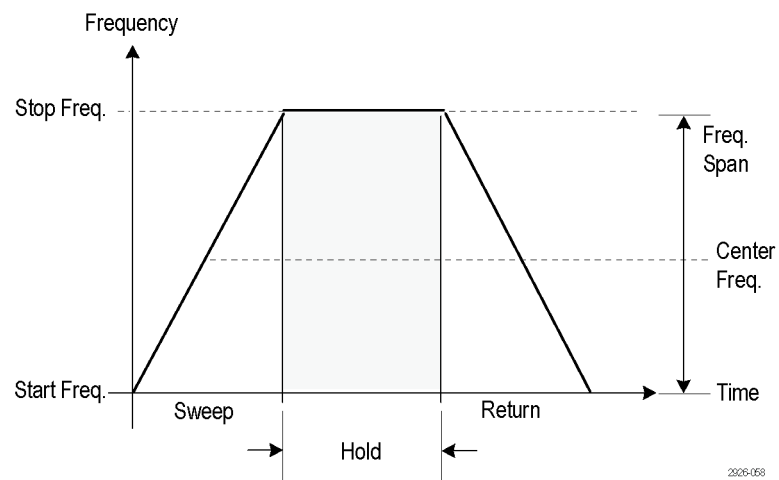

To set sweep parameters, do the following:

1. Select a waveform and then push the front-panel Sweep button.

NOTE. Pulse, DC, and Noise waveforms cannot be selected.

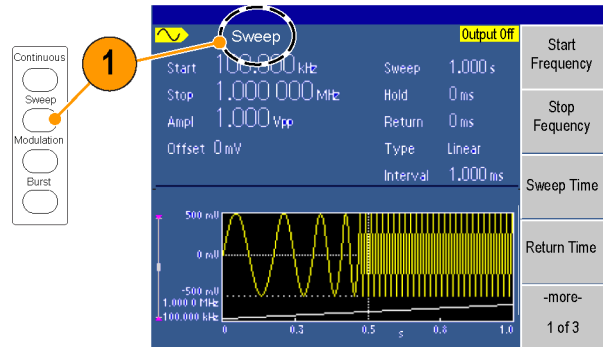

2. You can specify the start frequency, stop frequency, sweep time and return time from the sweep menu.

Return Time represents the amount of time from Stop Frequency to Start Frequency.

Push the -more- button to display the second sweep menu.

NOTE. If you want to return to the Sweep menu after selecting other menus, push the front-panel Sweep button again.

3. In this page, you can set the parameters for center frequency, frequency span, hold time and select the sweep type.

Hold time represents the amount of time that the frequency must remain stable after reaching the stop frequency.

Push the -more- button to display the second sweep menu.

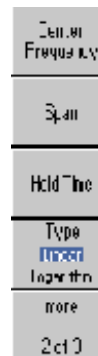

4. In this page, you can select the sweep mode (Repeat or Trigger) and trigger source.

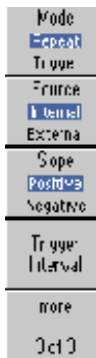

5. This is a sample oscilloscope screen. The top is a sample of a sweep waveform.
6. This is a trigger output signal.

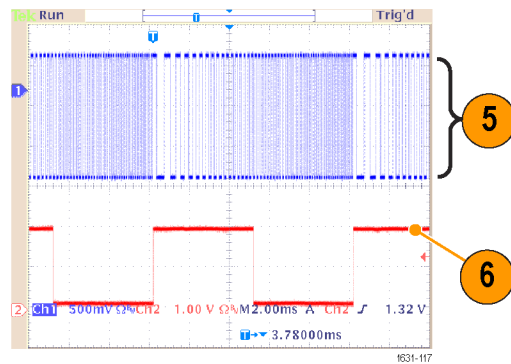

Sweep frequency facts

- If a start frequency is lower than a stop frequency, the instrument sweeps from the low frequency to the high frequency.
- If a start frequency is higher than a stop frequency, the instrument sweeps from the high frequency to the low frequency.
- Once the sweep is selected, the frequency is swept from the sweep start to the sweep stop frequencies.

Modulate a waveform

To output an AM waveform

1. Select a waveform and then push the front-panel Modulation button.
In this example, use sine waveform as an output waveform (carrier waveform).

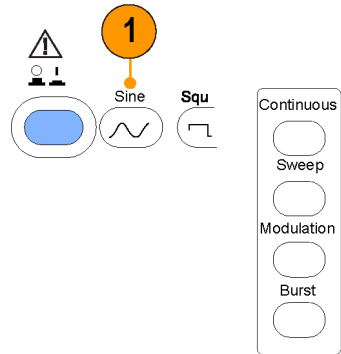

NOTE. You cannot select Pulse, Noise, or DC as a carrier waveform.

2. Push the top bezel button to display the modulation selection menu.
Select AM as the modulation type.



3. Select modulation source.
4. Set modulation frequency.
5. Select modulation shape.
6. Set modulation depth.

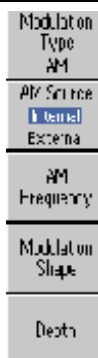

7. This is an example amplitude modulation waveform displayed on an oscilloscope screen.

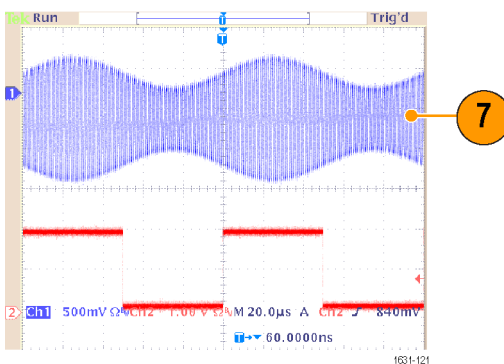

Modulation waveform facts and formulas

- You can output frequency modulation or phase modulation waveforms in the same way.
- You can select an internal or external signal as an AM source. If you select an external source and set the modulation depth to 120%, the output will be at the maximum amplitude when a $\pm 1 V_{p-p}$ signal is applied to the rear panel EXT MODULATION INPUT connector.
- You can select a modulation shape from the internal memory or USB memory.
- You cannot select Pulse, Noise, or DC as a carrier waveform.
- The following equations show the output amplitude of AM, FM, and PM modulation (in this example, sine waveform is used for carrier waveform and modulation waveform):

$$\text{AM: Output}(V_{p-p}) = \frac{A}{2.2} \left(1 + \frac{M}{100} \sin(2\pi f_m t) \right) \sin(2\pi f_c t)$$

$$\text{FM: Output}(V_{p-p}) = A \sin(2\pi (f_c + D \sin(2\pi f_m t)) t)$$

$$\text{PM: Output}(V_{p-p}) = A \sin(2\pi f_c t + 2\pi \frac{P}{360} \sin(2\pi f_m t))$$

| | |
|----------------------|---------|
| Carrier amplitude | A[Vp-p] |
| Carrier frequency | fc [Hz] |
| Modulation frequency | fm [Hz] |
| Time | t [sec] |

| | |
|---------------------|------------|
| AM Modulation depth | M [%] |
| FM Deviation | D [Hz] |
| PM Deviation | P [degree] |

- The following table shows relationship between modulation depth and maximum amplitude for AM modulation waveform (internal modulation source is selected):

| Depth | Maximum amplitude |
|-------|-----------------------|
| 120% | $A (V_{p-p})$ |
| 100% | $A (V_{p-p}) * 0.909$ |
| 50% | $A (V_{p-p}) * 0.682$ |
| 0% | $A (V_{p-p}) * 0.455$ |

To output an FSK waveform

Frequency Shift Keying modulation is a modulation technique that shifts the output signal frequency between two frequencies: the carrier frequency and Hop frequency. The AFG2021 generates a phase continuous FSK signal.

1. Follow the steps described in the *To output an AM waveform* procedure to display the modulation type selection submenu. (See page 53.)
In this example, select FSK as the modulation type.
2. The FSK parameter setting screen is displayed.
Select Internal or External as FSK source.
3. If you select Internal, you can set the FSK Rate.
If you select External, the FSK Rate is ignored.
4. Set Hop Frequency.
Carrier waveform frequency shifts to the Hop frequency with the specified FSK rate, and then returns to the original frequency.

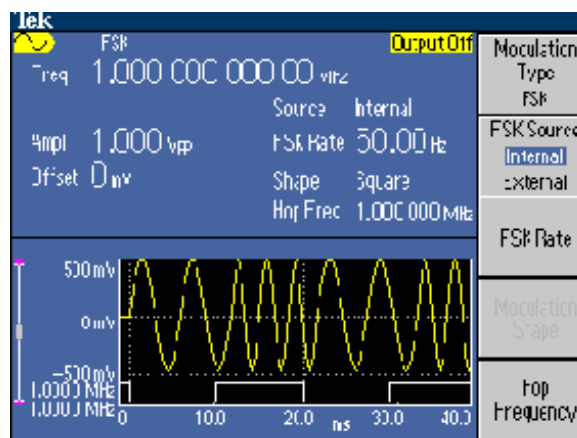

To output a PWM waveform Follow these steps to output a PWM waveform.

1. Push the front-panel Pulse button.
2. Push the Pulse Parameter Menu bezel button to display the pulse parameter setting screen.



3. Push the front-panel Modulation button to display the PWM parameter setting screen. Select the PWM source.
4. Set the PWM frequency.
5. Select the Modulation Shape.
6. Set the Deviation (pulse width deviation).

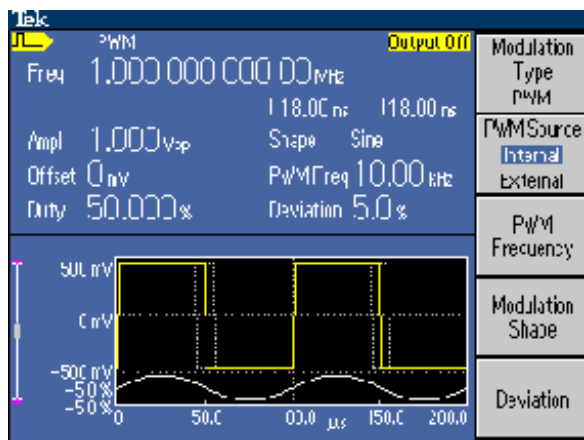

NOTE. Refer to the Motor speed control by pulse-width modulation for an application example of pulse-width modulation. (See page 82.)

Trigger out

The Trigger Output signal settings for the instrument are available from the mode selection menus. You can choose from the following trigger output selections:

1. Connect the front-panel Trigger Output connector and the external trigger input connector of the oscilloscope. The Trigger Output connector provides the trigger signal for oscilloscopes.

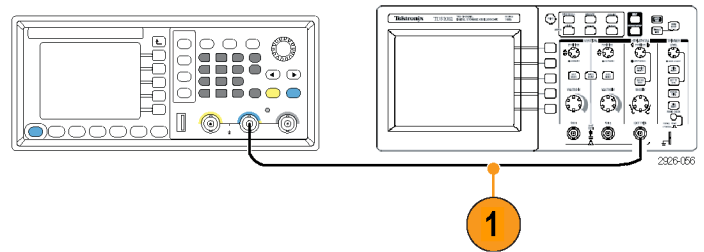

2. Continuous mode: The trigger output is a square waveform and the rising edge at the start of each waveform period. When an output frequency is higher than 4.9 MHz, some restrictions are applied. See the Quick Tips below.

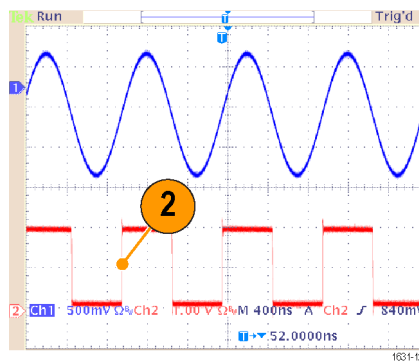

3. Sweep mode: When the Repeat or Trigger sweep mode and internal trigger source are selected, the trigger output is a square waveform and the rising edge at the start of each sweep.

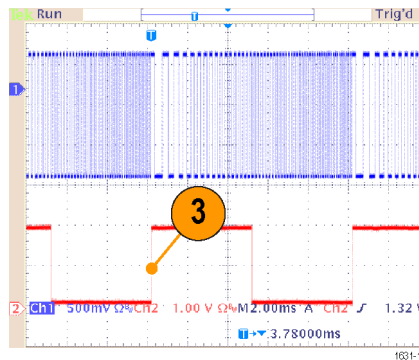

4. Modulation mode:
 When internal modulation source is selected, the trigger output is a square waveform of the same frequency as the modulating signal.
 When an external modulation source is selected, the trigger output is disabled.

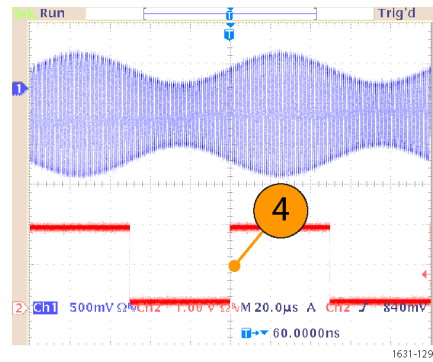

5. Burst Mode: When internal trigger source is selected, the trigger output is a square waveform and the rising edge at the start of each burst period.
 When an external trigger source is selected, the trigger output is high during the time the trigger input is high.

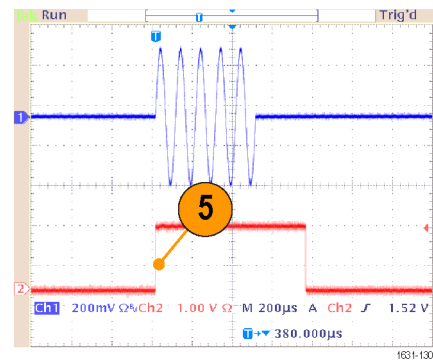

When a setting frequency of an output waveform is higher than 4.9 MHz, a divided frequency that is lower than 4.9 MHz is output from the Trigger Out. See the table below:

| Set frequency of output waveform (MHz) | Trigger output frequency (MHz) |
|--|--------------------------------|
| ~4.900 000 000 00 | Fs |
| 4.900 000 000 01 to 14.700 000 000 0 | Fs/3 |
| 14.700 000 000 1 to 20.000 000 000 0 | Fs/5 |

NOTE. When the instrument outputs a modulation waveform, the Trigger Output signal cannot be output if you select External as the modulation source.

Set up load impedance

The output impedance of the instrument is 50 Ω. If you connect a load other than 50 Ω, the displayed Amplitude, Offset, and High/Low values will be different from the output voltage. To make the displayed values the same as the output voltage, you need to set the load impedance. The load impedance is applied to the amplitude, offset, and high/low level settings. To set the load impedance, use the Output Menu.

1. From the top menu, push the Output Menu bezel button.
2. Push Load Impedance to display the Load Impedance submenu.

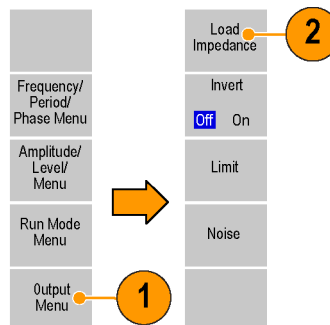

3. To adjust the load impedance, select Load.
4. You can set the load impedance to any value from 1 Ω to 10 kΩ.
5. When the load impedance is set to other than 50 Ω, the set value is displayed in the output status.

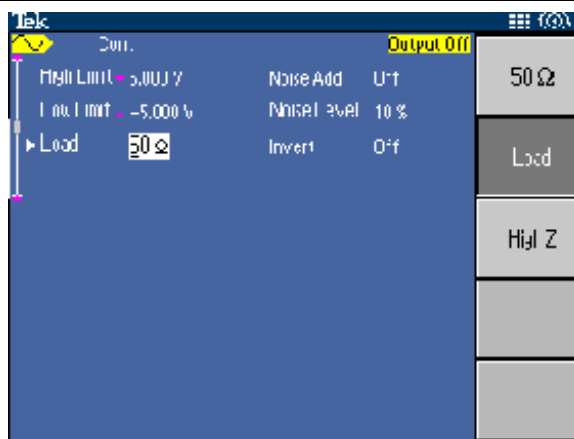

NOTE. When dBm is specified for output amplitude units, the amplitude units setting is automatically changed to Vpp if you select high impedance.

Add noise

To add the internal noise signal to a waveform, use the Output Menu.

1. Push the front-panel Sine button

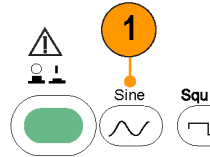

2. Push the Output Menu bezel button.
3. Push the Noise bezel button.

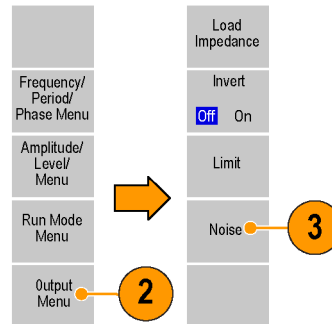

4. The Noise Add submenu is displayed. Push Noise Add to select On. To adjust the noise level, push Noise Level. Use the general purpose knob or the numeric keypad to enter the value.

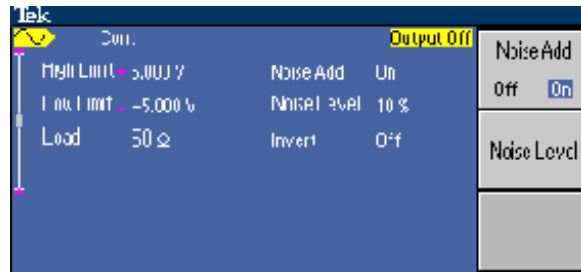

NOTE. When you set Noise Add to On, the amplitude of output signal is reduced to 50%.

5. This is a waveform before adding noise.

6. This is a waveform after adding noise.

To avoid overflow by noise addition, the amplitude of the output signal is automatically halved.

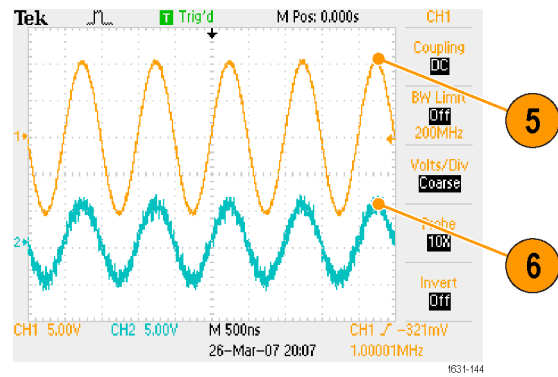

7. Push the front-panel Channel On/Off button so that the output is on and the LED is lit. The Output Status is changed from output status message will change to Noise.



NOTE. An internal noise generator (digital) is used to add noise.

Reference clock

The instrument can use an internal or external clock reference signal. When the external clock reference input is activated, the rear panel Ext Ref Input connector is used as the input for an external reference signal. The instrument is synchronized by this signal.

The following procedure shows you how to set up the instrument to use an external signal. Use of the internal signal does not require a connection to the rear-panel input.

1. Connect a reference signal from a signal source to the Ext Ref Input connector on the rear panel of the AFG2021.

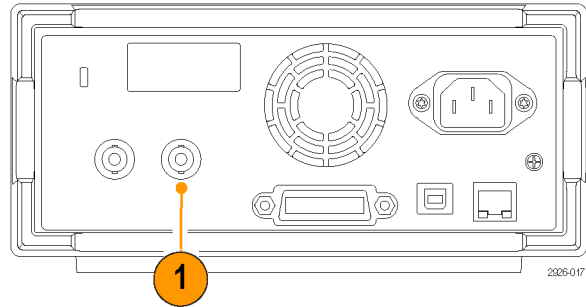

2. Push the front-panel Utility button.
3. Push the System bezel button.

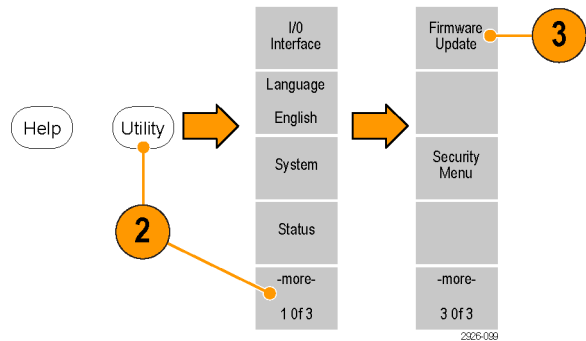

4. Push the Clock Ref bezel button to toggle between Internal and External.



Synchronous operation

To synchronize multiple instruments, use the Utility menu. The following image shows the correct setup. Some documentation may also refer to the synchronous operation as master-slave operation.

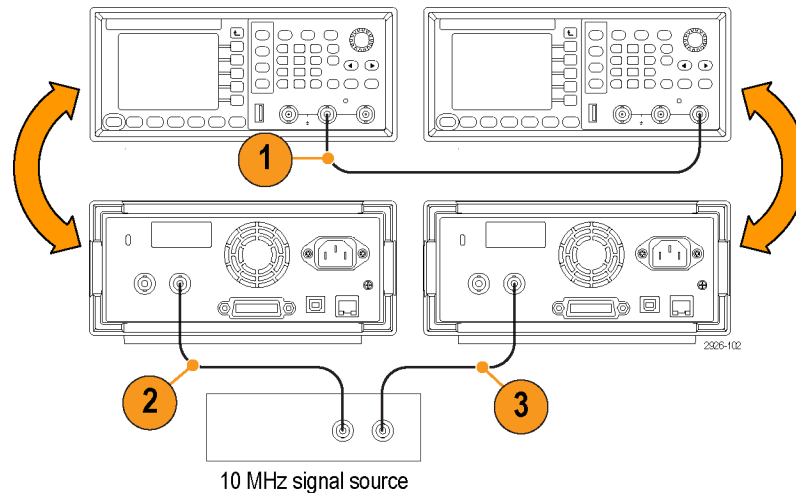

1. Use a BNC cable to connect the front-panel Trigger Output of one instrument (master) to the Trigger Input of another instrument (slave). The master unit sends a trigger signal to the slave unit.
2. Connect the rear panel Ext Ref Input (master) to a 10 MHz signal from another source.
3. Connect the rear panel Ext Ref Input (slave) to the 10 MHz signal source. This signal source controls the clock of the master and slave units.
4. Push the front-panel Utility button, and then push the System bezel button of the master unit to display the System menu.



USB memory

A USB memory connector, located on the front panel of the instrument, allows you to perform the following tasks:

- Save or recall user-defined waveforms to/from a USB memory device (See page 41, *Save/recall instrument setups.*)
- Save or recall setups to/from files on a USB memory device (See page 67, *Save/recall instrument setup.*)
- Update your instrument firmware (See page 13, *Update your instrument firmware.*)
- Save a screen image (See page 69, *Save a screen image.*)



CAUTION. *When you a USB memory device to the instrument, a caution message appears on the screen. Do not remove the USB memory device until the message disappears.*

If you remove the USB memory device while this caution message is displayed, it may cause damage to the instrument.

USB connector requirements

This instrument supports a USB memory with a FAT12, FAT16, or FAT32 file system.

Emissions may exceed the specification limit if a USB cable is placed in the front-panel USB memory connector. Use only appropriate USB memory devices.

Utility menu

Push the front-panel Utility button to display the Utility menu. The Utility menu provides access to utilities used by the instrument such as I/O interface, system related menus, diagnostics/calibration, and local language preferences.

1. Push the front-panel Utility button to display the Utility menu which has the following options.
2. **I/O interface** (See page 16, *Connect to a network.*)
3. **Language** (See page 9, *Select a local language.*)
4. **System related menus**, see step 6 and step 7.
5. Push the **Status** bezel button to display the instrument status.

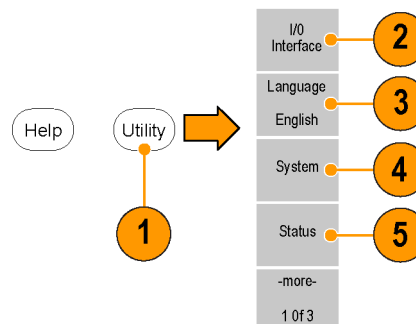

6. Push the System bezel button to display the System submenu. For **Trigger Out** information (See page 57.).
7. For **Clock Reference** information (See page 62.).
8. You can select the instrument power-on settings.
9. Executing the **Secure** function will erase all data except Mac Address, calibration data, and the instrument serial number.

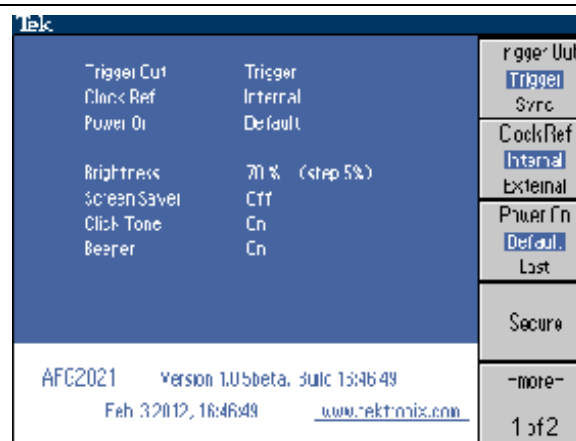

10. Push the -more- button to display the second page. Push Brightness to adjust the screen contrast.
11. Push Screen Saver to toggle the screen saver Off and On.
12. Push Click Tone to toggle the click tone Off and On.
13. Push Beeper to toggle the beep sound Off and On.

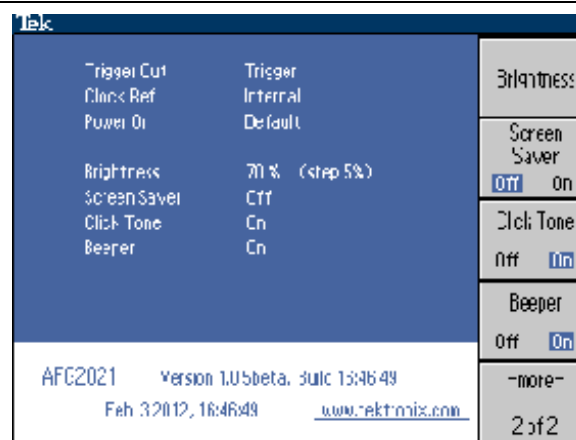

14. Push the top menu front-panel button to return to the previous menu. Push the -more- button to display the second page.

Diagnostics/
Calibrator

Backup/
Restore

15. For Backup/Restore, see step 16.

16. Push the Backup/Restore bezel button to display the Backup/Restore submenu. In this menu, you can back up a waveform data from internal memory to USB memory, or restore a waveform data from USB memory to internal memory.

Type
Setup
All

Backup
Internal →
USB Memory

Restore
Internal ←
USB Memory

Change
Directory

Make
Directory

17. Return to the Utility main menu. Push the -more- bezel button to display the third page. On this page, you can execute the instrument firmware update. (See page 13.)

Firmware
Update

Service
Menu

Security
Menu

18. **Security Menu** (See page 70.).

more
3 of 3

Save/recall instrument setup

You can save setups of the instrument as files in the internal memory or in an external USB memory device. Setup files saved to a USB memory device are saved with the extension TFS. You can recall the stored setups from a file in the internal memory or in a USB memory device.

1. Push the front-panel Save/Recall button to display the Save Menu.



2. To specify a memory location, select Internal or USB.
3. Use the general purpose knob to scroll files. Push Save to save a setting to Internal memory.

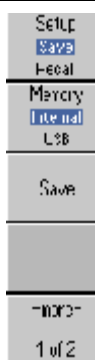

NOTE. A *Save As* menu option appears when you are saving to USB memory.

4. You can save a setup as a new file if you specify USB. Push Save As.



5. You can enter a file name in this screen. Use the general purpose knob to select a character. Push the Enter Character bezel button or the front-panel Enter key to enter the character.

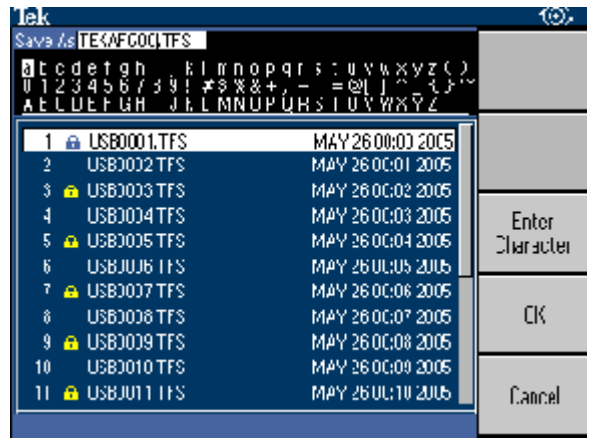

6. To recall a setup, push the Setup bezel button to select Recall.
7. Push the Recall bezel button.



NOTE. Output state is Off by default after reading a setup file.

Lock setup files

You can lock a setup file to avoid accidental overwrite. When a memory location is locked, a lock key icon will appear on the screen. To lock or unlock a setup file, push the Lock/Unlock bezel button located on the second page of the Save/Recall menu.

Erase a file

To erase a file, push the Erase bezel button located on the second page of the Save/Recall menu.

Save a screen image

You can save a screen image of the instrument to a USB memory. Do the following steps:

1. Insert a USB memory to the front-panel USB connector.

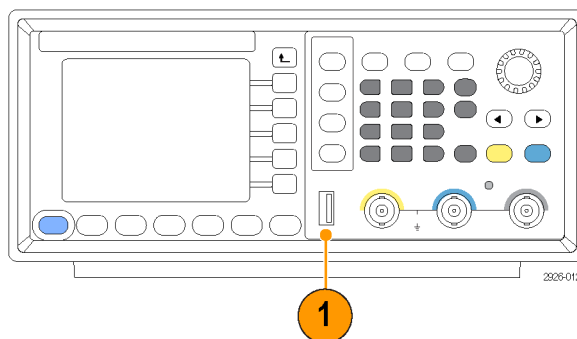

2. Set the display to show the screen you want to save as image. Then simultaneously push the two arrow keys underneath the general purpose knob on the front panel.
3. A message appears on the screen, indicating that the screen image was saved.

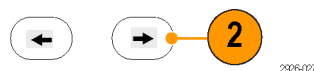

NOTE. Image files are saved in a folder named "TEK" in the USB memory device.

4. Push OK.

NOTE. Image files are saved as .BMP format. The instrument gives all files created by the instrument the default name TEK00nnn.BMP, where the nnn are placeholders for an automatic number sequence from 000 to 999.

Security menu

Use the Security menu to limit access to the Firmware Update and Service menus (refer to the Service manual for information about the service menu). From the Security Menu, you can set access protection and change passwords.

Access protection

In the **Access Protection** menu, you can set a password that must be entered for a firmware update to be implemented. Access protection is set to Off by default. To turn it on, do the following:

1. Push the front-panel Utility button to display the Utility menu, and then push the -more- bezel button twice.
2. Select Security Menu.

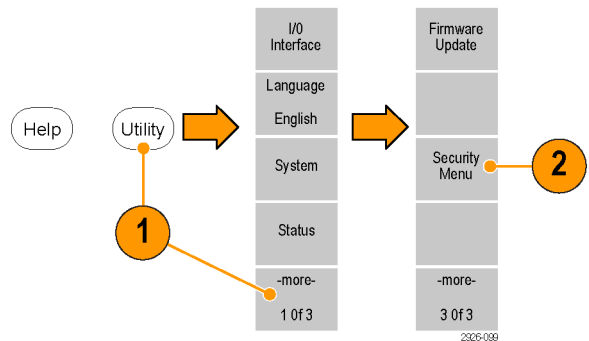

3. Select Access Protection to display the password input page.

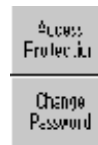

4. Enter your password. Use the general purpose knob to select the characters and push the Enter Character bezel button after each selection. As you enter the characters of your password, they are displayed as a series of asterisks (*****) on the password input page. If no specific password has been previously defined, use the default password DEFAULT.
5. Select OK to turn the access protection on.



NOTE. When Access Protection is on, the Change Password bezel button is disabled.

Change the password

Before the password is changed for the first time, the default password is DEFAULT. To change the password, do the following steps:

1. Select Security Menu from the Utility menu.
2. If the Access Protection is set to On, turn it off using the Access Protection menu. Otherwise, skip to step .

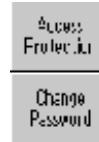

3. Select Change Password to display the password input page.
4. Enter your current password.
Use the general purpose knob to select the characters and push the Enter Character bezel button after each selection. Then select OK to display the New Password input page.

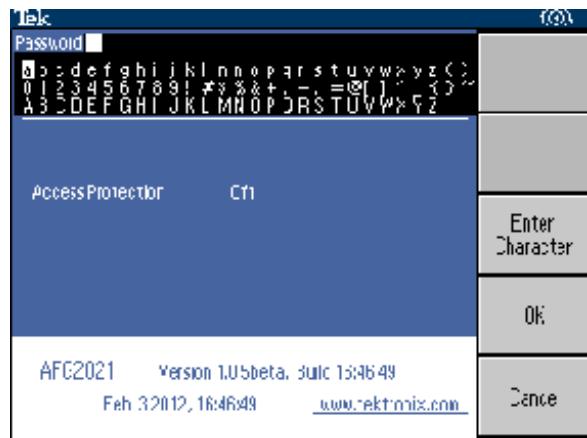

5. Enter a new password. Use the front-panel general purpose knob to select a character , and then push the Enter Character bezel button. You can also use the front-panel numeric keypad and the Enter button.

As you enter the characters of your new password, they are displayed on the screen. Check carefully to ensure you are entering the desired characters.

6. Select OK to activate the new password.

NOTE. A password must have at least four characters, and not more than 12 characters.



NOTE. To activate or deactivate the access protection, you must enter the password you set. If you forget the password, you must return the instrument to Tektronix to reset the password.

ArbExpress

ArbExpress is a Windows-based software for creating and editing waveforms for Tektronix AWG and AFG instruments. With ArbExpress, you can quickly and conveniently create the desired waveforms and send them to the instrument.

The following table and list describe the system requirements and general features.

System requirements

| | |
|-------------------------|--|
| OS Supported | Windows XP Professional or Windows 2000 or Windows 98/Me or Windows NT or Windows 7 (32-bit only) |
| Minimum PC Requirements | Pentium III 800 MHz and higher 256 MB RAM 300 MB free hard disk Microsoft Internet Explorer 5.01 and higher .NET Framework 1.1 Redistributable 800 x 600 Display resolution |
| TekVISA | Version 3.3.4.6 and above |

- Create waveforms from standard waveform templates
- Modify and transfer waveforms to perform DUT level tests
- Directly import waveforms from Tektronix oscilloscopes
- Send waveforms to AWG/AFG instruments directly from ArbExpress or MATLAB
- Math operations on waveforms

NOTE. You can use ArbExpress to transfer waveform data to the instrument. When you transfer waveform data (.tfw file), any part of the waveform outside of allowed limits in the AFG2021 will be automatically converted to be within the allowed range.

The following pages contain the screen interface and basic operating procedures for using ArbExpress. For more information on ArbExpress, refer to the ArbExpress online help.

Screen interface

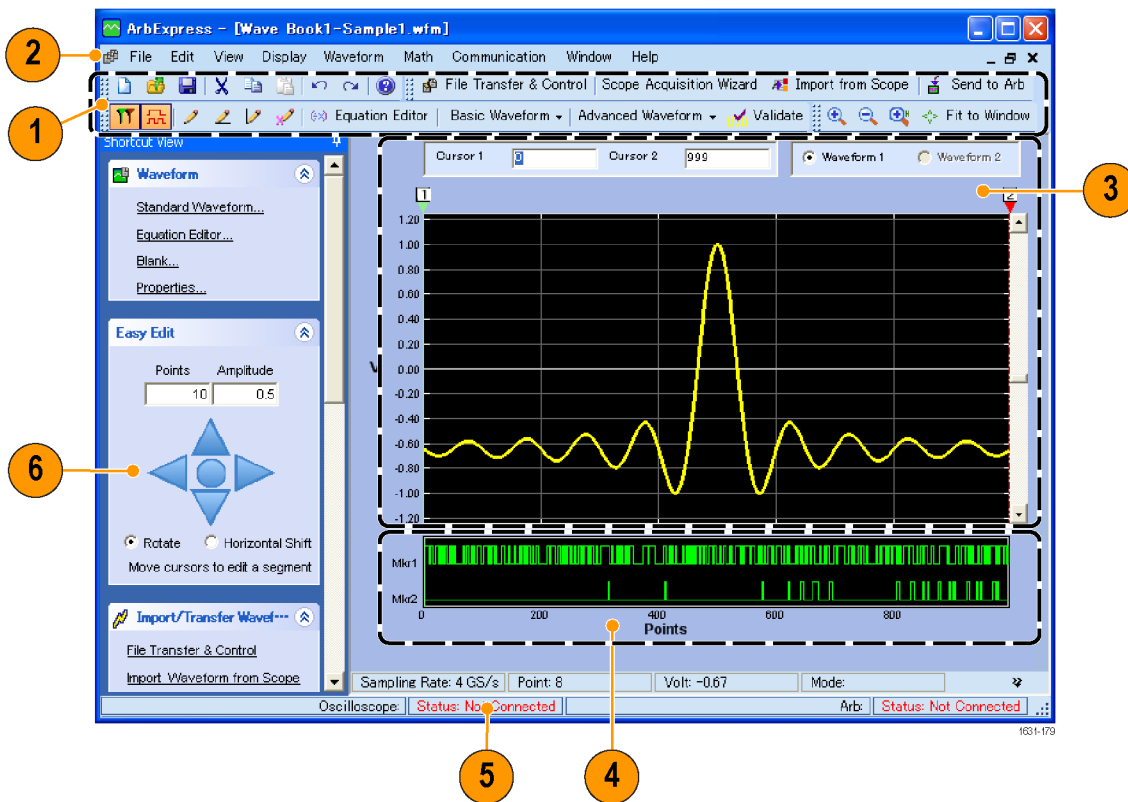

| Item | Description |
|------|---|
| 1 | Menu bar: The menu bar provides access to the application functions. When you select a menu item, the application displays the associated dialog box or the menu selection causes an immediate action. |
| 2 | Toolbar: The toolbar buttons provide instant access to most features without having to navigate through several menus. |
| 3 | Shortcut View: The Shortcut view occupies the left part of the display. Use the Shortcut view to quickly access various functions provided by the application. Refer to the ArbExpress online help for more information. |
| 4 | Status bar: The status bar, located below the waveform and marker display, shows information about the application and the waveform. |
| 5 | Waveform display area: When you create or open a waveform, it will be displayed in this area. |
| 6 | Marker area: Marker patterns appear in this area. You can toggle the display of markers by selecting Display > Marker from the menu bar. |

Basic operations

The following steps explain basic waveform creation and other useful functions that are available with ArbExpress.

1. To create a new waveform, use the File menu.
2. Blank sheet opens a blank sheet in the window with 1024 points waveform length. You can change the number of points using Properties... from the Waveform menu.

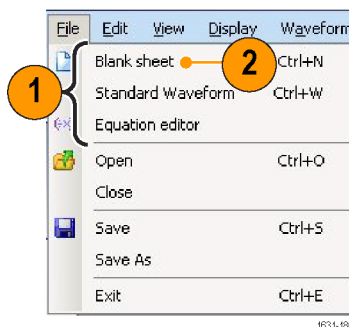

3. Use the Standard Waveform dialog box to create any of the standard waveforms that are available. Use Settings to select a desired waveform and instrument type.
4. Use Vertical to set the waveform vertical parameters.
5. Use Horizontal to set the waveform horizontal parameters.
6. Click Preview to view the waveform.

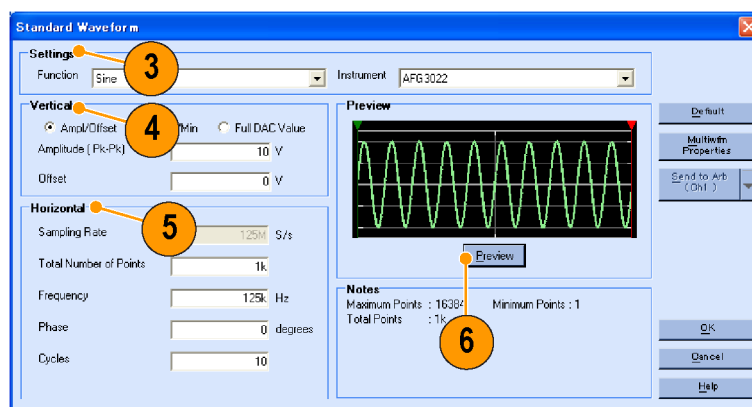

7. You can also use the Equation Editor to create a waveform. The application provides a set of sample equations that you can directly use or modify.
8. Use Command List to select the commands, functions, units, and operations.
9. Use Preview to view the waveform after the equation is compiled.

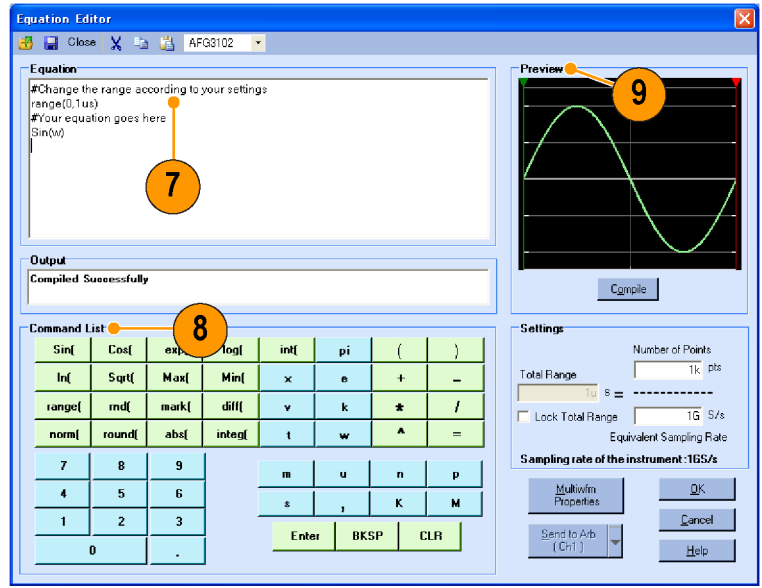

10. You can also use a waveform math tool. From the Math menu, select Waveform Math... to display the Waveform Math dialog box.
11. Select a math source from Waveform Library. Select Noise in this example.
12. Calculation results are displayed in the Resultant Waveform pane. This is an example of adding noise to a square waveform.

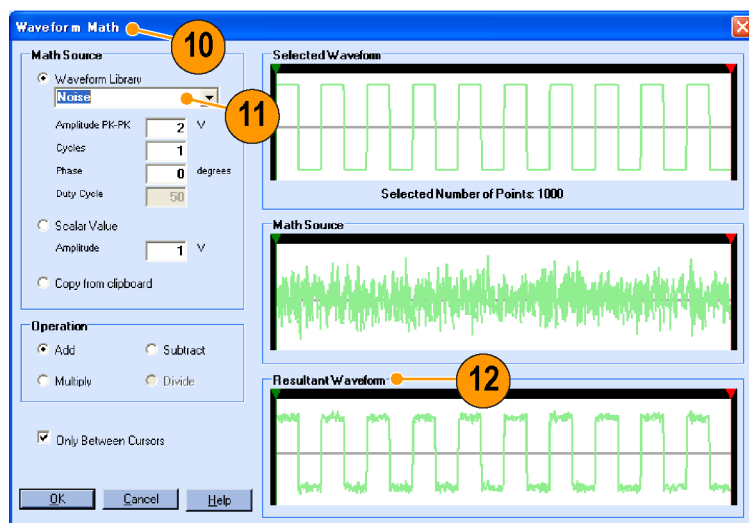

13. You can remotely control Tektronix AWG/AFG instruments using ArbExpress. From the Communication menu, select AWG/AFG File Transfer & Control... to display the dialog box.
14. Connected instruments are listed on the Arb List.
15. The Instrument Control pane appears only when an instrument is connected, otherwise it is hidden.

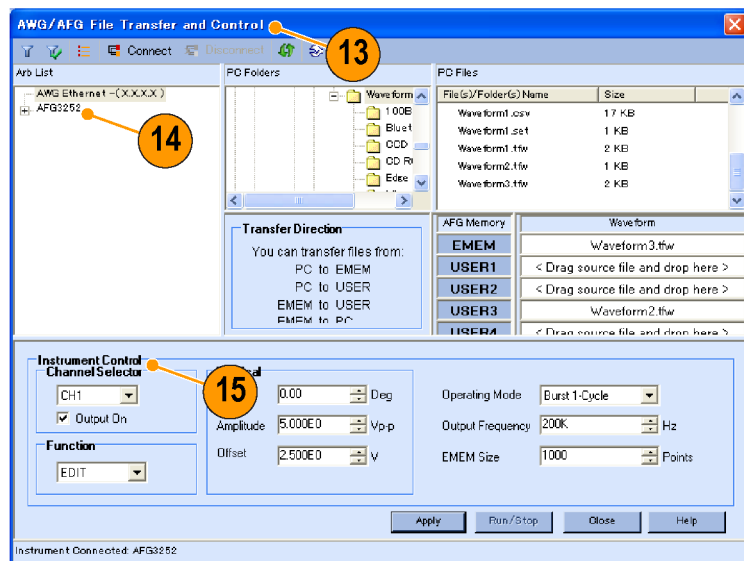

Using CSV format waveform data

ArbExpress allows you to convert a CSV (Comma Separated Value) format file, which is created by Microsoft Excel, to waveform data that is compatible with the instrument.

1. Create a CSV file to use with ArbExpress.
2. Enter point or time to this column.
3. Enter data to this column.

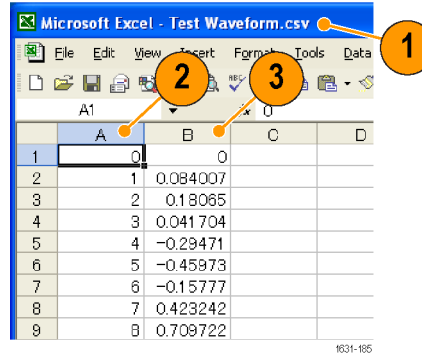

When you open a CSV file, a dialog box may appear to confirm the CSV file format.

4. This is an example of ArbExpress waveform display area after recalling CSV data.

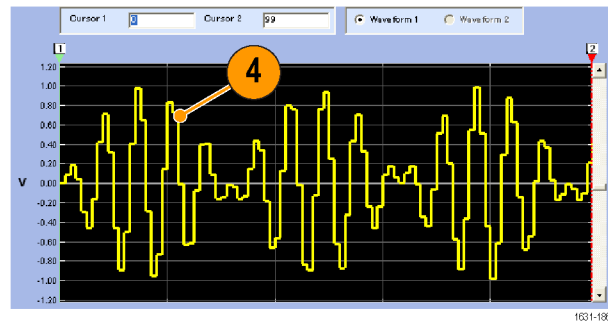

5. Save the waveform as the .tfw format.
Copy the waveform data to a USB memory and load the waveform in the arbitrary/function generator.

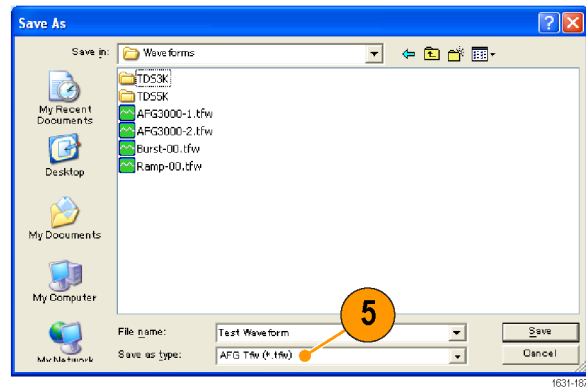

6. The AFG2021 outputs recalled waveform data. This is an example of the oscilloscope screen.

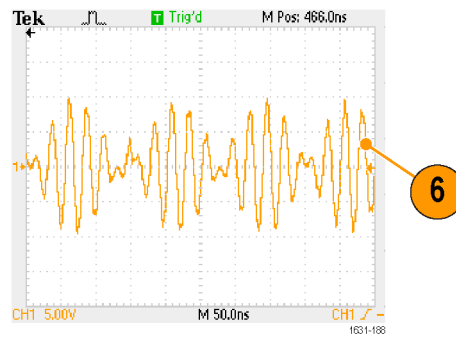

¹ Fs represents setting frequency of output waveform.

Application examples

This section contains a series of application examples. These simplified examples highlight the features of the instrument and give you ideas for using it to solve your own test problems.

Measurement of filter characteristics

Use the instrument sweep function to observe the frequency characteristics of the 50 Ω filter.

1. Connect the Channel Output of the instrument to the CH1 input of an oscilloscope with a BNC cable.
2. Connect a 50 Ω filter between the Channel Output and CH1 input of the oscilloscope.
3. Connect the Trigger Output of the instrument and the external trigger input connector of an oscilloscope.
Set the oscilloscope input impedance to 50 Ω .

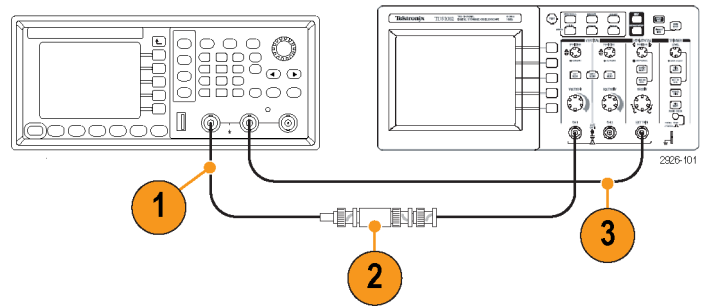

4. Select Sweep from Run Mode of the instrument and set the start frequency, stop frequency, and sweep time so that the waveform is shown in the graticule.
You can measure the frequency characteristics of the filter by sweep time and the oscilloscope time base.

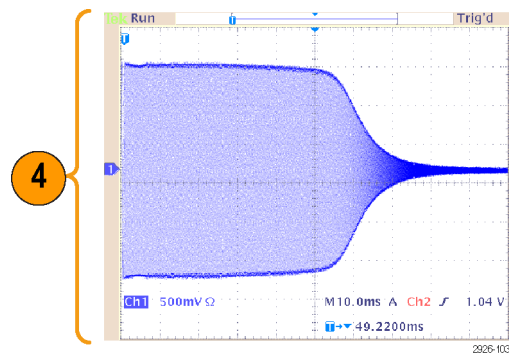

Motor speed control by pulse-width modulation

Pulse-width modulation is used for controlling the speed of a DC motor or the luminance of an LED (Light Emitting Diode). Use the instrument PWM function to control the DC motor speed.

1. Connect the instrument output and a DUT using a BNC-to-alligator clip adapter.

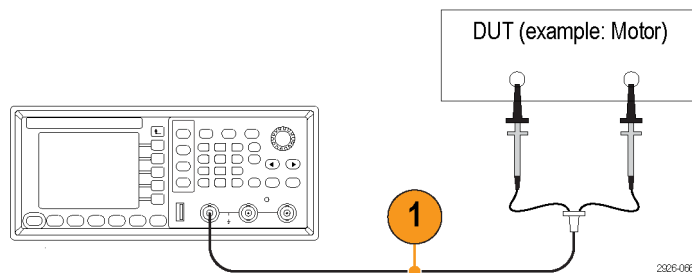

2. Push the front-panel Pulse button and the Modulation button, and then select PWM as a modulation type. Set the frequency to approximately 100 kHz.

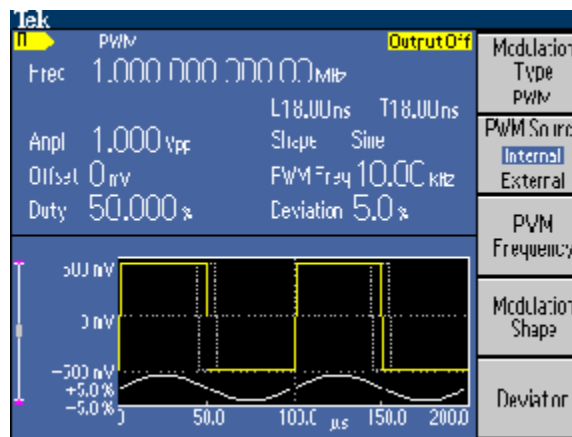

3. Connect the output to an oscilloscope. Confirm that a pulse-width modulation waveform is displayed on the oscilloscope screen. Select Pulse Duty and change the duty rate. Observe that the motor speed changes if you change the duty rate.

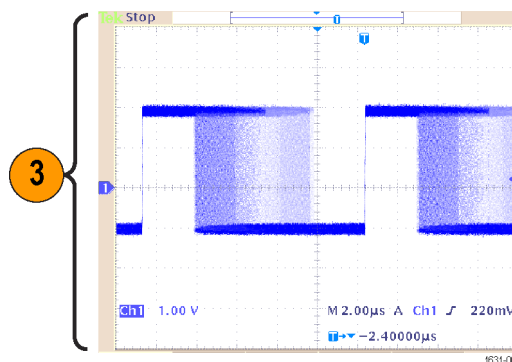

Carrier null (frequency modulation)

Use the instrument and spectrum analyzer to observe a carrier waveform of frequency modulation.

1. Select Sine as an output waveform and then select FM as the modulation type.
2. Set the waveform parameters as follows:
 - Carrier frequency: 1 MHz
 - Modulation frequency: 2 kHz

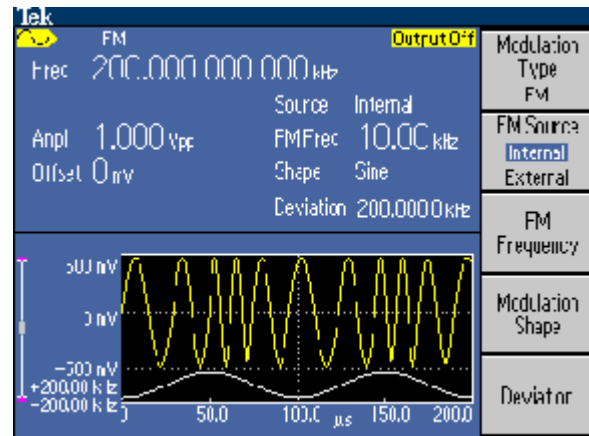

3. Change Deviation.
Set the deviation to 4.8096 kHz. It makes the carrier waveform null. Confirm that the carrier null can be observed on the spectrum analyzer.

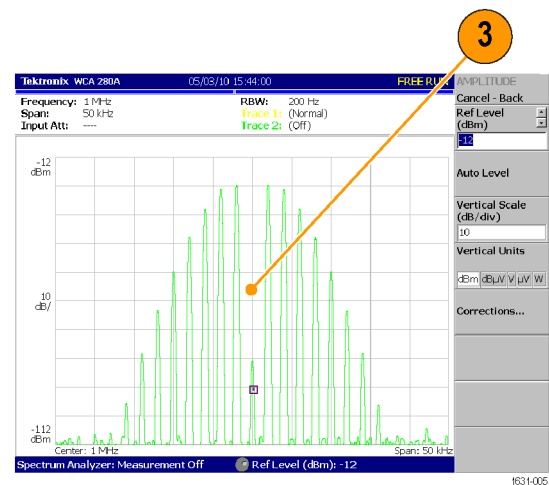

Characteristics

General

| Characteristic | Description |
|------------------------------------|--|
| Channels | 1 |
| Waveforms | Sine, Square, Pulse, Ramp, Noise, DC, Sin(x)/x, Gaussian, Lorentz, Exponential Rise, Exponential Decay, and Haversine |
| Sine Wave | 1 μ Hz to 20 MHz |
| Sine Wave in Burst Mode | 1 μ Hz to 10 MHz |
| Effective Maximum Frequency Out | 20 MHz |
| Amplitude Flatness (1 V_{p-p}) | |
| <5 MHz | ± 0.15 dB |
| 5 MHz to 20 MHz | ± 0.3 dB |
| Harmonic Distortion (1 V_{p-p}) | |
| 10 Hz to 20 kHz | < -70 dBc |
| 20 kHz to 1 MHz | < -60 dBc |
| 1 MHz to 10 MHz | < -50 dBc |
| 10 MHz to 20 MHz | < -40 dBc |
| THD | $< 0.2\%$ (10 Hz to 20 kHz, 1 V_{p-p}) |
| Spurious (1 V_{p-p}) | |
| 10 Hz to 1 MHz | < -60 dBc |
| 1 MHz to 20 MHz | < -50 dBc |
| Phase Noise, Typical | 20 MHz: < -110 dBc/Hz at 10 kHz offset, 1 V_{p-p} |
| Residual Clock Noise | -63 dBm |
| Square Wave | 1 μ Hz to 10 MHz |
| Rise/Fall Time | ≤ 18 ns |
| Jitter (RMS), Typical | < 500 ps |
| Ramp Wave | 1 μ Hz to 200 kHz |
| Linearity | $\leq 0.1\%$ of peak output at 10% to 90% of amplitude range |
| Symmetry | 0.0% to 100.0% |
| Pulse Wave | 1 mHz to 10 MHz |
| Pulse Width | 30.00 ns to 999.99 s |
| Resolution | 10 ps or 5 digits |
| Pulse Duty | 0.001% to 99.999% (Limitations of pulse duty width apply) |
| Edge Transition Time | 18 ns to $0.625 \times$ Pulse Period |
| Resolution | 10 ps or 4 digits |
| Lead Delay | |
| Range | Continuous Mode: 0 ps to Period Trigger/Gate Burst Mode: 0 ps to Period – [Pulse Width + 0.8 \times (Leading Edge Time + Trailing Edge Time)] |
| Resolution | 10 ps or 8 digits |
| Overshoot, Typical | $< 5\%$ |
| Jitter (RMS), Typical | < 500 ps |

| Characteristic | Description |
|---------------------------------------|---|
| Other Waveforms | 1 μ Hz to 200 kHz |
| Noise Bandwidth (-3 dB) | 20 MHz |
| Noise Type | White Gaussian |
| DC (into 50 Ω) | -5 V to $+5$ V |
| Arbitrary Waveforms | 1 mHz to 10 MHz |
| Arbitrary Waveforms in Burst Mode | 1 mHz to 5 MHz |
| Effective Analog Bandwidth (-3 dB) | 34 MHz |
| Nonvolatile Memory | 4 waveforms |
| Memory: Sample Rate | 2 to 128k: 250 MS/s |
| Vertical Resolution | 14 bits |
| Rise/Fall Time | ≤ 20 ns |
| Jitter (RMS) | 4 ns |
| Amplitude, 50 Ω Load | 10 m V_{p-p} to 10 V_{p-p} |
| Amplitude, Open Circuit | 20 m V_{p-p} to 20 V_{p-p} |
| Accuracy | $\pm(1\%$ of setting + 1 mV), (1 kHz sine waveform, 0 V offset, > 10 m V_{p-p} amplitude) |
| Resolution | 0.1 m V_{p-p} , 0.1 m V_{RMS} , 1 mV, 0.1 dBm, or 4 digits |
| Units | V_{p-p} , V_{RMS} , dBm (sine wave only) |
| Output Impedance | 50 Ω |
| Load Impedance Setting | Selectable: 50 Ω , 1 Ω to 10.0 k Ω , High Z (adjusts displayed amplitude according to selected load impedance) |
| Isolation | $< 42 V_{Peak}$ maximum to earth |
| Short-circuit Protection | Signal outputs are robust against permanent shorts against floating ground |
| External Voltage Protection | To protect signal outputs against external voltages use fuse adapter 013-0345-00 |
| DC Offset Range, 50 Ω Load | $\pm(5 V_{Peak} - \text{amplitude } V_{p-p}/2)$ |
| DC Offset Range, Open Circuit | $\pm(10 V_{Peak} - \text{amplitude } V_{p-p}/2)$ |
| Accuracy | $\pm(1\%$ of setting + 5 mV + 0.5% of amplitude (V_{p-p})) |
| Resolution | 1 mV |

Modulation**AM, FM, PM**

| Characteristic | Description |
|-------------------------------|--|
| Carrier Waveforms | All, including ARB, except Pulse, Noise, and DC |
| Source | Internal/External |
| Internal Modulating Waveform | Sine, Square, Ramp, Noise, ARB (AM: Maximum waveform length 4,096; FM/PM: Maximum waveform length 2,048) |
| Internal Modulating Frequency | 2 mHz to 50.00 kHz |
| AM Modulation Depth | 0.0% to +120.0% |
| Min FM Peak Deviation | DC |
| Max FM Peak Deviation | 10 MHz |

Frequency Shift Keying

| Characteristic | Description |
|-------------------------------|---|
| Carrier Waveforms | All, including ARB, except Pulse, Noise, and DC |
| Source | Internal/External |
| Internal Modulating Frequency | 2 mHz to 1.000 MHz |
| Number of Keys | 2 |

Pulse Width Modulation

| Characteristic | Description |
|-------------------------------|--|
| Carrier Waveform | Pulse |
| Source | Internal/External |
| Internal Modulating Waveform | Sine, Square, Ramp, Noise, ARB (Maximum waveform length 2,048) |
| Internal Modulating Frequency | 2 mHz to 50.00 kHz |
| Deviation | 0% to 50.0% of pulse period |

Sweep

| Characteristic | Description |
|--|--|
| Waveforms | All, including ARB, except Pulse, Noise, and DC |
| Type | Linear, Logarithmic |
| Sweep Time | 1 ms to 300 s |
| Hold/Return Time | 0 ms to 300 s |
| Max Total Sweep Time (Sweep + Hold + Return) | 300 s |
| Resolution | 1 ms or 4 digits |
| Total Sweep Time Accuracy, Typical | 0.4% |
| Min Start/Stop Frequency | All except ARB: 1 μ Hz ARB: 1 mHz |
| Max Start/Stop Frequency | Sine: 20 MHz Square: 10 MHz ARB: 10 MHz Others: 200 kHz |

Burst

| Characteristic | Description |
|--------------------------|--|
| Waveforms | All, including ARB, except Noise and DC |
| Type | Triggered, Gated (1 to 1,000,000 cycles or Infinite) |
| Internal Trigger Rate | 1 μ s to 500.0 s |
| Gate and Trigger Sources | Internal, External, Manual Trigger, and Remote Interface |

Auxiliary Input**Modulation Input**

| Characteristic | Description |
|-----------------|--|
| Input Range | All except FSK: ± 1 V full scale FSK: 3.3 V logic level |
| Impedance | 10 k Ω |
| Frequency Range | DC to 25 kHz (122 kS/s sample rate) |

External Triggered/Gated Burst Input

| Characteristic | Description |
|-----------------------|---|
| Level | TTL compatible |
| Pulse Width | 100 ns minimum |
| Slope | Positive/Negative selectable |
| Trigger Delay | 0.0 ns to 85.000 s |
| Resolution | 100 ps or 5 digits |
| Jitter (RMS), Typical | Burst: <500 ps (Trigger input to signal output) |

10 MHz Reference Input

| Characteristic | Description |
|------------------------------|---|
| Impedance | 1 k Ω , AC coupled |
| Required Input Voltage Swing | 100 mV _{p-p} to 5 V _{p-p} |
| Lock Range | 10 MHz ± 35 kHz |

Auxiliary Output**Trigger Output**

| Characteristic | Description |
|-----------------------|--|
| Level | Positive TTL level pulse into 1 k Ω |
| Impedance | 50 Ω |
| Jitter (RMS), Typical | 500 ps |
| Max Frequency | 4.9 MHz (4.9 MHz to 20 MHz: A fraction of the frequency is output) |

Common Characteristics

Remote Programming (GPIB, LAN 10BASE-T/100BASE-TX, USB 1.1, compatible with SCPI-1999.0 and IEEE 488-2 standards)

| Characteristic | USB | LAN*1 | GPIB*1 |
|---|-------|--------|--------|
| Function Change | 95 ms | 103 ms | 84 ms |
| Frequency Change | 2 ms | 19 ms | 2 ms |
| Amplitude Change | 60 ms | 67 ms | 52 ms |
| Select User ARB | 88 ms | 120 ms | 100 ms |
| Data Download Time for 4k Point ARB Waveform Data (8 KB), Typical | 20 ms | 84 ms | 42 ms |

*1 GPIB and LAN interfaces are only available on the instrument with Option GL.

General

| Characteristic | Description |
|-------------------------------------|--|
| Frequency Setting Resolution | 1 μ Hz or 12 digits |
| Phase (except DC, Noise, Pulse) | |
| Range | -360° to +360° |
| Resolution | Sine: 0.01° Other Waveforms: 0.1° |
| Internal Noise Add | When activated, output signal amplitude is reduced to 50% |
| Level | 0.0% to 50% of amplitude (V_{p-p}) setting |
| Resolution | 1% |
| Main Output | 50 Ω |
| Effective Frequency Switching Speed | 2 ms through remote control |
| Internal Frequency Reference | |
| Stability | All except ARB: ± 1 ppm, 0 °C to 50 °C ARB: ± 1 ppm, ± 1 μ Hz, 0 °C to 50 °C |
| Aging | ± 1 ppm per year |
| Power Source | 100 V to 240 V, 50 Hz to 60 Hz or 115 V, 400 Hz |
| Power Consumption | 60 W |
| Warm-up Time, Typical | 20 minutes |
| Power On Self Diagnostics, Typical | <10 s |
| Acoustic Noise, Typical | <50 dBA |
| Display | 3.5 in. Color TFT LCD |
| User Interface and Help Language | English, French, German, Japanese, Korean, Simplified and Traditional Chinese, Russian (User selectable) |

Physical Characteristics

Benchtop Configuration

| Dimension | mm | in. |
|-----------|-------|-------|
| Height | 104.2 | 4.10 |
| Weight | 241.8 | 9.52 |
| Depth | 419.1 | 16.50 |
| Weight | kg | lb. |
| Net | 2.87 | 6.3 |
| Shipping | 4.72 | 10.4 |

Environmental and Safety Characteristics

| Characteristic | Description |
|----------------|---|
| Temperature | |
| Operating | 0 °C to +50 °C |
| Nonoperating | -30 °C to +70 °C |
| Humidity | |
| Operating | $\leq 80\%$, +0 °C to +40 °C, noncondensing $\leq 60\%$, +40 °C to +50 °C, noncondensing |
| Nonoperating | 5% to 90%, <+40 °C, noncondensing 5% to 80%, $\geq +40$ °C to $\leq +60$ °C, noncondensing 5% to 40%, >+60 °C to $\leq +70$ °C, noncondensing |
| Altitude | |
| Operating | Up to 3,000 m (9,842 ft.) |
| Nonoperating | Up to 12,000 m (39,370 ft.) |
| EMC Compliance | EU Council Directive 2004/108/EC |
| Safety | UL61010-1; 2004 CAN/CSA C22.2 No. 61010-1; 2004 EN61010-1; 2001 IEC61010-1; 2001 |

Ordering Information

AFG2021

Arbitrary/Function Generator.

Includes: User Manual, Power Cord, USB Cable, CD-ROM with Programmer Manual, Service Manual, Labview and IVI Drivers, CD-ROM with ArbExpress® Software, NIST-traceable Calibration Certificate.

Please specify power cord and local language for user manual when ordering.

Configuration Options

| Option | Description |
|---------|-------------------------|
| Opt. GL | GPIB and LAN interfaces |

Language Options

| Option | Description |
|----------|----------------------------|
| Opt. L0 | English manual |
| Opt. L1 | French manual |
| Opt. L2 | Italian manual |
| Opt. L3 | German manual |
| Opt. L4 | Spanish manual |
| Opt. L5 | Japanese manual |
| Opt. L6 | Portuguese manual |
| Opt. L7 | Simplified Chinese manual |
| Opt. L8 | Traditional Chinese manual |
| Opt. L9 | Korean manual |
| Opt. L10 | Russian manual |
| Opt. L99 | No manual |

Index

A

- Access Protection
 - Utility button security menu, 70
- Access protection 67
 - Connecting to a network, 16
- Access Protection 67
 - Firmware update, 14
- Add Noise, 60
- Amplitude, To change the units, 32
- Application examples
 - Frequency modulation, 83
 - Measurement of filter characteristics, 81
 - Pulse-width modulation, 82
- Arb button (front panel)
 - Recalling arbitrary waveforms, 41
- ArbExpress
 - screen interface, 74
- ArbExpress 69, 79
- ArbExpress 69, 73
 - Saving arbitrary waveform, 41
- ArbExpress ix, xi, 73
- ArbExpress ix, 69
 - Basic operations, 75

B

- Beeper
 - Utility menu, 65
- Bezel menu
 - screen interface, 23
- Burst waveform
 - generate, 47

C

- Carrier null, Application examples, 83
- Center frequency
 - sweep waveform, 50

- Changing the password, Security menu, 71
- Channel output On/Off, 33
- Chassis ground screw
 - rear panel, 33
- Click tone
 - Utility menu, 65
- Clock reference
 - external, 62
 - internal, 62
- Connect to a network
 - Ethernet, 16
- Connecting to a network 18
 - Language selection, 9
- CSV file, ArbExpress, 78

D

- DC
 - standard waveform, 28
- Default button, 7
- Default settings, 25
- Default setup, 24
- Default, Power on settings, 6

E

- Edit menu, 43
- Edit menu 38
 - Recalling waveform data, 43
- Editing arbitrary waveforms
 - example 1, 45
 - example 2, 46
- Environmental requirements, 4
- Equation Editor, ArbExpress, 76
- Equivalent output circuits, 21
- Erase
 - saved setup files, 41
- Erase setup files
 - Save/Recall menu, 68
- Ethernet 18
 - GPIO, 19
- Exponential decay
 - standard waveform, 28

- Exponential rise
 - standard waveform, 28
- EXT MODULATION INPUT connector
 - rear panel, 34
- EXT REF INPUT connector
 - rear panel, 34
- External reference input
 - rear panel, 62

F

- Fan vent
 - rear panel, 34
- Firmware updates, 13
- Firmware updates 15
 - Save a screen image, 69
- Floating ground, 11
- Formulas
 - modulation waveforms, 54
- Frequency span
 - sweep waveform, 50
- Front panel, 22
- Front panel controls
 - how to lock or unlock, 23
- Fuse adapter, Protect output circuits, 10

G

- Gated burst waveform
 - generate, 48
- Gaussian
 - standard waveform, 28
- General features, 1
- Generate a burst waveform, 47
- Generate a pulse waveform, 39
- Generate a pulse waveform 35
 - To generate a sine waveform, 35
- Generate a sine waveform, 35
- Generate an arbitrary waveform, 42
- Generate DC, 47
- Generate Noise, 47

- GPIB connector
 - rear panel, 33
- Graph display area
 - screen interface, 23
- H**
- Haversine
 - standard waveform, 28
- Help
 - how to access instrument, 38
 - instrument, 38
 - navigation, 38
- Hold time
 - sweep waveform, 50
- I**
- Instrument power-on and power-off, 5
- Instrument settings when powered-on, 6, 7
- L**
- LAN connector
 - rear panel, 33
- Language selection 11
 - Self test and self calibration, 7
- Last, Power on settings, 6, 7
- Level meter
 - screen interface, 23
- Lissajous patterns 75
 - Pulse-width modulation, 82
- Load impedance 22, 21, 59
- Lock front panel controls, 23
- Lock setup files
 - Save/Recall menu, 68
- Lock/unlock
 - saved setup files, 41
- Lock/Unlock button
 - Save/Recall menu, 68
- Lorentz
 - standard waveform, 28
- M**
- Main display area
 - screen interface, 23
- Master-slave operation, 63
- Measurement of filter characteristics
 - Application examples, 81
- Message display area
 - screen interface, 23
- Modify an arbitrary waveform, 43
- Modulate a waveform, 53
- Modulation waveform formulas
 - AM, 54
 - FM, 54
 - PM, 54
- N**
- Noise
 - standard waveform, 28
- Noise 56
 - screen interface, 23
- Number of Points, Edit menu, 43
- O**
- Operating requirements, 4
- Option buttons, 23
- Output menu
 - To add Noise, 60
- Output On/Off
 - channel, 33
- Output status
 - Noise, 60
- Output window, 21
- P**
- Parameter display area
 - screen interface, 23
- Password
 - Security menu, 71
- Power button, 5
- Power consumption, 4
- Power input
 - rear panel, 33
- Power off, 5
- Power on, 5
- Power supply requirements, 4
- Procedure
 - To adjust waveform parameters, 30
- Programmer Manual ix, xi, 20
- Protect output circuits, Fuse adapter, 10
- Protect your DUT, 12
- Pulse waveform formulas, 39
- Pulse-width modulation
 - Application examples, 82
- Pulse-width modulation 77
 - Sweep, 81
- R**
- Rear panel, 33
- Recalling waveform data 38
 - Saving waveform data, 44
- Recommended accessories, 3
- Reference signal, Internal or External, 62
- Remote control, ArbExpress, 77
- Return time
 - sweep waveform, 50
- Run Mode, 29
- S**
- Safety Summary, iv
- Save a screen image, 69
- Save a waveform
 - Save/Recall arbitrary waveform, 41
- Save/Recall arbitrary waveform 36
 - Save/Recall instrument setup, 67
- Save/Recall instrument setup, 67
- Save/Recall instrument setup 65
 - To generate an arbitrary waveform, 42
- Screen image
 - save, 69
- Screen interface, 23
- Screen interface 70
 - System requirements, 73
- Screen saver
 - Utility menu, 65
- Secure function
 - Utility menu, 65
- Security menu, 70

- Security menu 67
 - Firmware update, 16
 - Security slot
 - rear panel, 34
 - Selecting a local language, 9
 - Self calibration, 7
 - Self test and self calibration
 - synchronous operation, 63
 - Self test, Utility menu, 7
 - Set up load impedance, 59
 - Setups
 - Save and recall, 41
 - Side-menu buttons, 23
 - Sin(x)/x
 - standard waveform, 28
 - Soft keys, 23
 - Standard accessories, 2
 - Standard Waveform dialog box,
 - ArbExpress, 75
 - Standard waveforms, 26
 - Stop frequency
 - sweep waveform, 50
 - Sweep, 50
 - Sweep time
 - sweep waveform, 50
 - Sweep waveform
 - Application examples, 81
 - Synchronous operation, 63
 - Synchronous operation 60
 - Updating instrument firmware, 13
- T**
- TFS file, Saving instrument setup, 67
 - To adjust waveform parameters 31
 - To connect to a network, 16
 - To connect to a network 18
 - To generate a pulse waveform, 39
 - To generate a sine waveform 2
 - To generate an arbitrary waveform, 42
 - To generate an arbitrary waveform 37
 - To modify an arbitrary waveform, 43
 - To invert waveform 55
 - To protect your DUT, 12
 - To modify an arbitrary waveform 38
 - To output a PWM waveform, 56
 - To output a PWM waveform 49
 - To output an AM waveform, 53
 - To output an AM waveform 46
 - To output an FSK waveform, 55
 - To output an FSK waveform 48
 - To restore the default setup, 24
 - To protect your DUT 14
 - To set up load impedance, 59
 - To select a local language, 9
 - To select a waveform, 26
 - To select a waveform 28
 - To select Run Mode, 29
 - To select Run Mode 30
 - To sweep a waveform, 50
 - Trigger out, 57
 - Trigger output connector, 57
 - Triggered burst waveform generate, 48
- U**
- Unlock front panel controls, 23
 - USB connector requirements, 64
 - USB interface
 - rear panel, 16
 - USB memory, 64
 - USB memory 62
 - Firmware updates, 13
 - USB type B connector
 - rear panel, 33
 - Utility menu, 65
 - Utility menu 63
 - Access protection, 70
- V**
- Ventilation vent
 - rear panel, 34
 - Voltage units, Conversion table of Vp-p, Vrms, and dBm, 32
- W**
- Waveform display area
 - screen interface, 23
 - Waveform Math dialog box,
 - ArbExpress, 77
 - Waveform parameter, how to change, 30
 - Waveforms
 - Save and recall, 41