



# PRESETTABLE BCD/DECADE UP/DOWN COUNTER

## PRESETTABLE 4-BIT BINARY UP/DOWN COUNTER

The SN54/74LS192 is an UP/DOWN BCD Decade (8421) Counter and the SN54/74LS193 is an UP/DOWN MODULO-16 Binary Counter. Separate Count Up and Count Down Clocks are used and in either counting mode the circuits operate synchronously. The outputs change state synchronous with the LOW-to-HIGH transitions on the clock inputs.

Separate Terminal Count Up and Terminal Count Down outputs are provided which are used as the clocks for a subsequent stages without extra logic, thus simplifying multistage counter designs. Individual preset inputs allow the circuits to be used as programmable counters. Both the Parallel Load (PL) and the Master Reset (MR) inputs asynchronously override the clocks.

- Low Power . . . 95 mW Typical Dissipation
- High Speed . . . 40 MHz Typical Count Frequency
- Synchronous Counting
- Asynchronous Master Reset and Parallel Load
- Individual Preset Inputs
- Cascading Circuitry Internally Provided
- Input Clamp Diodes Limit High Speed Termination Effects

CONNECTION DIAGRAM DIP (TOP VIEW)

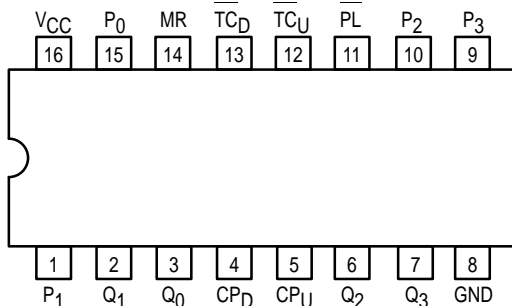

NOTE:  
The Flatpak version has the same pinouts (Connection Diagram) as the Dual In-Line Package.

**PIN NAMES**

CP <sub>U</sub>	Count Up Clock Pulse Input
CP <sub>D</sub>	Count Down Clock Pulse Input
MR	Asynchronous Master Reset (Clear) Input
PL	Asynchronous Parallel Load (Active LOW) Input
P <sub>n</sub>	Parallel Data Inputs
Q <sub>n</sub>	Flip-Flop Outputs (Note b)
TC <sub>D</sub>	Terminal Count Down (Borrow) Output (Note b)
TC <sub>U</sub>	Terminal Count Up (Carry) Output (Note b)

NOTES:

- a. 1 TTL Unit Load (U.L.) = 40 μA HIGH/1.6 mA LOW.  
 b. The Output LOW drive factor is 2.5 U.L. for Military (54) and 5 U.L. for Commercial (74) Temperature Ranges.

**LOADING (Note a)**

	HIGH	LOW
CP <sub>U</sub>	0.5 U.L.	0.25 U.L.
CP <sub>D</sub>	0.5 U.L.	0.25 U.L.
MR	0.5 U.L.	0.25 U.L.
PL	0.5 U.L.	0.25 U.L.
P <sub>n</sub>	0.5 U.L.	0.25 U.L.
Q <sub>n</sub>	10 U.L.	5 (2.5) U.L.
TC <sub>D</sub>	10 U.L.	5 (2.5) U.L.
TC <sub>U</sub>	10 U.L.	5 (2.5) U.L.

**SN54/74LS192**  
**SN54/74LS193**

**PRESETTABLE BCD/DECADE  
UP/DOWN COUNTER**  
**PRESETTABLE 4-BIT BINARY  
UP/DOWN COUNTER**  
**LOW POWER SCHOTTKY**

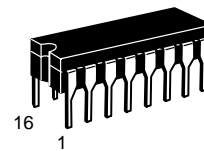

**J SUFFIX**  
CERAMIC  
CASE 620-09

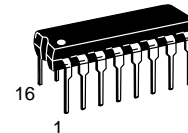

**N SUFFIX**  
PLASTIC  
CASE 648-08

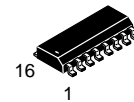

**D SUFFIX**  
SOIC  
CASE 751B-03

**ORDERING INFORMATION**

SN54LSXXXJ	Ceramic
SN74LSXXXN	Plastic
SN74LSXXXD	SOIC

**LOGIC SYMBOL**

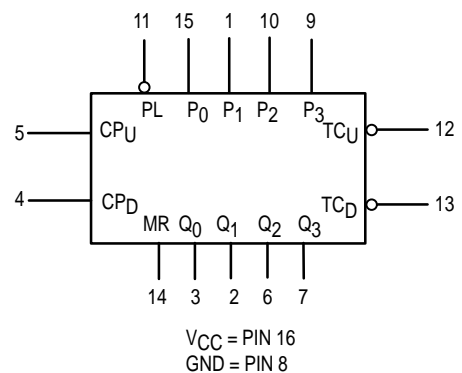

# SN54/74LS192 • SN54/74LS193

## STATE DIAGRAMS

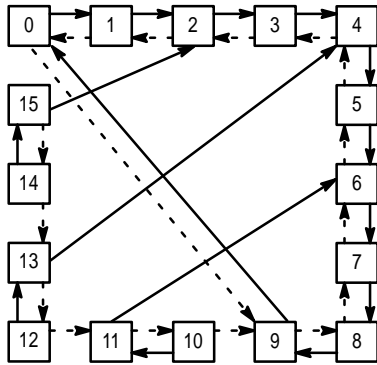

LS192

### LS192 LOGIC EQUATIONS FOR TERMINAL COUNT

$$\overline{TC_U} = Q_0 \cdot Q_3 \cdot \overline{CP_U}$$

$$TC_D = Q_0 \cdot Q_1 \cdot Q_2 \cdot Q_3 \cdot CP_D$$

### LS193 LOGIC EQUATIONS FOR TERMINAL COUNT

$$\overline{TC_U} = Q_0 \cdot Q_1 \cdot Q_2 \cdot Q_3 \cdot \overline{CP_U}$$

$$TC_D = Q_0 \cdot Q_1 \cdot Q_2 \cdot Q_3 \cdot CP_D$$

COUNT UP ————  
COUNT DOWN - - - - -

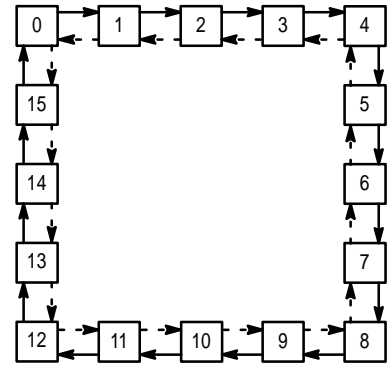

LS193

## LOGIC DIAGRAMS

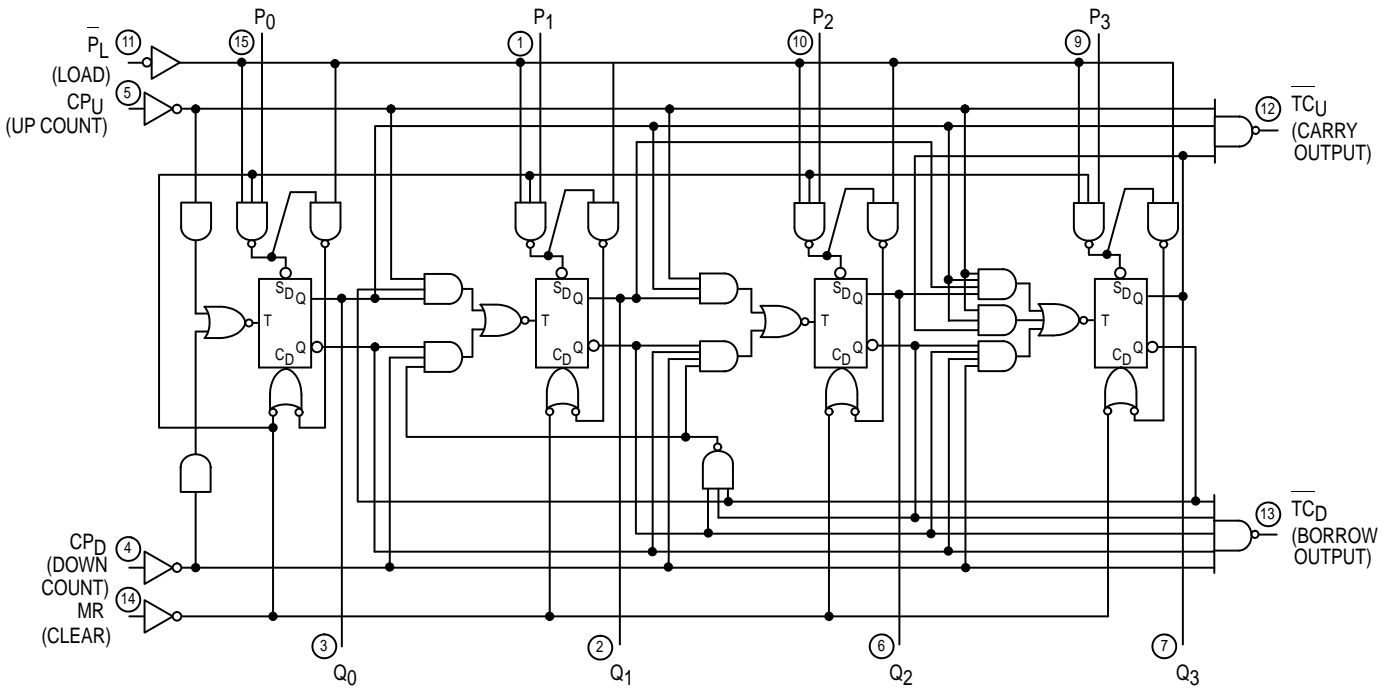

LS192

V<sub>CC</sub> = PIN 16  
GND = PIN 8  
○ = PIN NUMBERS

# SN54/74LS192 • SN54/74LS193

## LOGIC DIAGRAMS (continued)

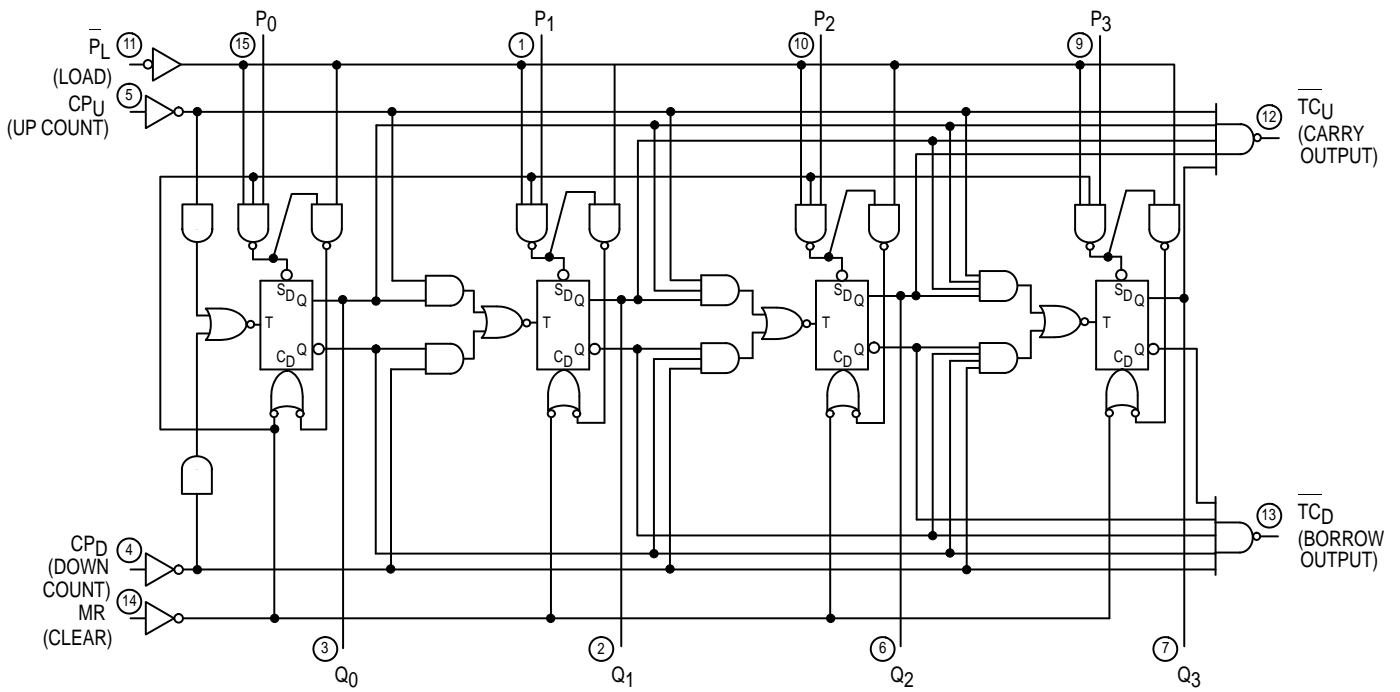

LS193

V<sub>CC</sub> = PIN 16  
 GND = PIN 8  
 ○ = PIN NUMBERS

# SN54/74LS192 • SN54/74LS193

## FUNCTIONAL DESCRIPTION

The LS192 and LS193 are Asynchronously Presettable Decade and 4-Bit Binary Synchronous UP/DOWN (Reversible) Counters. The operating modes of the LS192 decade counter and the LS193 binary counter are identical, with the only difference being the count sequences as noted in the State Diagrams. Each circuit contains four master/slave flip-flops, with internal gating and steering logic to provide master reset, individual preset, count up and count down operations.

Each flip-flop contains JK feedback from slave to master such that a LOW-to-HIGH transition on its T input causes the slave, and thus the Q output to change state. Synchronous switching, as opposed to ripple counting, is achieved by driving the steering gates of all stages from a common Count Up line and a common Count Down line, thereby causing all state changes to be initiated simultaneously. A LOW-to-HIGH transition on the Count Up input will advance the count by one; a similar transition on the Count Down input will decrease the count by one. While counting with one clock input, the other should be held HIGH. Otherwise, the circuit will either count by twos or not at all, depending on the state of the first flip-flop, which cannot toggle as long as either Clock input is LOW.

The Terminal Count Up ( $\overline{TC_U}$ ) and Terminal Count Down ( $\overline{TC_D}$ ) outputs are normally HIGH. When a circuit has reached the maximum count state (9 for the LS192, 15 for the LS193), the next HIGH-to-LOW transition of the Count Up Clock will cause  $\overline{TC_U}$  to go LOW.  $\overline{TC_U}$  will stay LOW until  $CP_U$  goes HIGH again, thus effectively repeating the Count Up Clock, but delayed by two gate delays. Similarly, the  $\overline{TC_D}$  output will go LOW when the circuit is in the zero state and the Count Down Clock goes LOW. Since the TC outputs repeat the clock waveforms, they can be used as the clock input signals to the next higher order circuit in a multistage counter.

Each circuit has an asynchronous parallel load capability permitting the counter to be preset. When the Parallel Load (PL) and the Master Reset (MR) inputs are LOW, information present on the Parallel Data inputs ( $P_0, P_3$ ) is loaded into the counter and appears on the outputs regardless of the conditions of the clock inputs. A HIGH signal on the Master Reset input will disable the preset gates, override both Clock inputs, and latch each Q output in the LOW state. If one of the Clock inputs is LOW during and after a reset or load operation, the next LOW-to-HIGH transition of that Clock will be interpreted as a legitimate signal and will be counted.

MODE SELECT TABLE

MR	PL	CP <sub>U</sub>	CP <sub>D</sub>	MODE
H	X	X	X	Reset (Asyn.)
L	L	X	X	Preset (Asyn.)
L	H	H	H	No Change
L	H	┐	H	Count Up
L	H	H	┘	Count Down

L = LOW Voltage Level

H = HIGH Voltage Level

X = Don't Care

┐ = LOW-to-HIGH Clock Transition

# SN54/74LS192 • SN54/74LS193

## GUARANTEED OPERATING RANGES

Symbol	Parameter		Min	Typ	Max	Unit
V <sub>CC</sub>	Supply Voltage	54 74	4.5 4.75	5.0 5.0	5.5 5.25	V
T <sub>A</sub>	Operating Ambient Temperature Range	54 74	-55 0	25 25	125 70	°C
I <sub>OH</sub>	Output Current — High	54, 74			-0.4	mA
I <sub>OL</sub>	Output Current — Low	54 74			4.0 8.0	mA

## DC CHARACTERISTICS OVER OPERATING TEMPERATURE RANGE (unless otherwise specified)

Symbol	Parameter	Limits			Unit	Test Conditions	
		Min	Typ	Max			
V <sub>IH</sub>	Input HIGH Voltage	2.0			V	Guaranteed Input HIGH Voltage for All Inputs	
V <sub>IL</sub>	Input LOW Voltage	54		0.7	V	Guaranteed Input LOW Voltage for All Inputs	
		74		0.8			
V <sub>IK</sub>	Input Clamp Diode Voltage		-0.65	-1.5	V	V <sub>CC</sub> = MIN, I <sub>IN</sub> = -18 mA	
V <sub>OH</sub>	Output HIGH Voltage	54	2.5	3.5	V	V <sub>CC</sub> = MIN, I <sub>OH</sub> = MAX, V <sub>IN</sub> = V <sub>IH</sub> or V <sub>IL</sub> per Truth Table	
		74	2.7	3.5	V		
V <sub>OL</sub>	Output LOW Voltage	54, 74		0.25	0.4	V	I <sub>OL</sub> = 4.0 mA V <sub>CC</sub> = V <sub>CC</sub> MIN, V <sub>IN</sub> = V <sub>IL</sub> or V <sub>IH</sub> per Truth Table
		74		0.35	0.5	V	
I <sub>IH</sub>	Input HIGH Current			20	μA	V <sub>CC</sub> = MAX, V <sub>IN</sub> = 2.7 V	
				0.1	mA	V <sub>CC</sub> = MAX, V <sub>IN</sub> = 7.0 V	
I <sub>IL</sub>	Input LOW Current			-0.4	mA	V <sub>CC</sub> = MAX, V <sub>IN</sub> = 0.4 V	
I <sub>OS</sub>	Short Circuit Current (Note 1)	-20		-100	mA	V <sub>CC</sub> = MAX	
I <sub>CC</sub>	Power Supply Current			34	mA	V <sub>CC</sub> = MAX	

Note 1: Not more than one output should be shorted at a time, nor for more than 1 second.

## AC CHARACTERISTICS (T<sub>A</sub> = 25°C)

Symbol	Parameter	Limits			Unit	Test Conditions
		Min	Typ	Max		
f <sub>MAX</sub>	Maximum Clock Frequency	25	32		MHz	V <sub>CC</sub> = 5.0 V C <sub>L</sub> = 15 pF
t <sub>PLH</sub> t <sub>PHL</sub>	$\overline{CP_U}$ Input to TC <sub>U</sub> Output		17 18	26 24	ns	
t <sub>PLH</sub> t <sub>PHL</sub>	$\overline{CP_D}$ Input to TC <sub>D</sub> Output		16 15	24 24	ns	
t <sub>PLH</sub> t <sub>PHL</sub>	Clock to Q		27 30	38 47	ns	
t <sub>PLH</sub> t <sub>PHL</sub>	$\overline{PL}$ to Q		24 25	40 40	ns	
t <sub>PHL</sub>	MR Input to Any Output		23	35	ns	

## SN54/74LS192 • SN54/74LS193

### AC SETUP REQUIREMENTS ( $T_A = 25^\circ\text{C}$ )

Symbol	Parameter	Limits			Unit	Test Conditions
		Min	Typ	Max		
$t_W$	Any Pulse Width	20			ns	$V_{CC} = 5.0\text{ V}$
$t_s$	Data Setup Time	20			ns	
$t_h$	Data Hold Time	5.0			ns	
$t_{rec}$	Recovery Time	40			ns	

### DEFINITIONS OF TERMS

**SETUP TIME ( $t_s$ )** is defined as the minimum time required for the correct logic level to be present at the logic input prior to the PL transition from LOW-to-HIGH in order to be recognized and transferred to the outputs.

**HOLD TIME ( $t_h$ )** is defined as the minimum time following the PL transition from LOW-to-HIGH that the logic level must be maintained at the input in order to ensure continued recogni-

tion. A negative HOLD TIME indicates that the correct logic level may be released prior to the PL transition from LOW-to-HIGH and still be recognized.

**RECOVERY TIME ( $t_{rec}$ )** is defined as the minimum time required between the end of the reset pulse and the clock transition from LOW-to-HIGH in order to recognize and transfer HIGH data to the Q outputs.

# SN54/74LS192 • SN54/74LS193

## AC WAVEFORMS

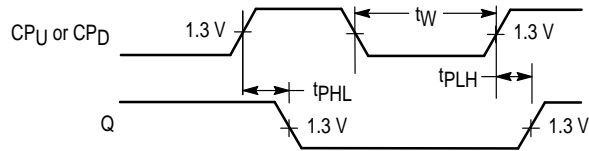

Figure 1

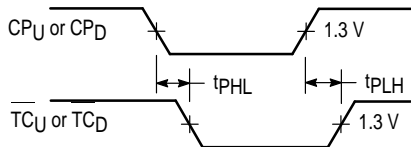
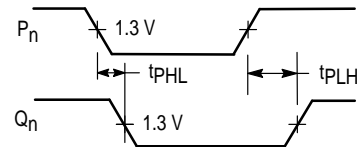

Figure 2



NOTE: PL = LOW

Figure 3

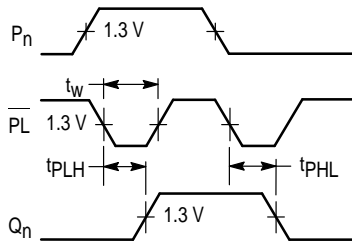

Figure 4

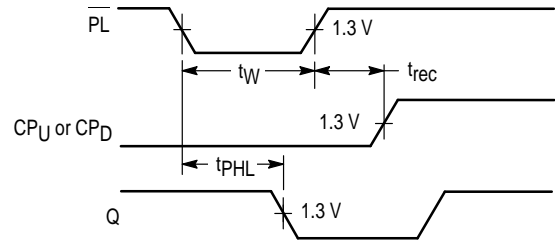
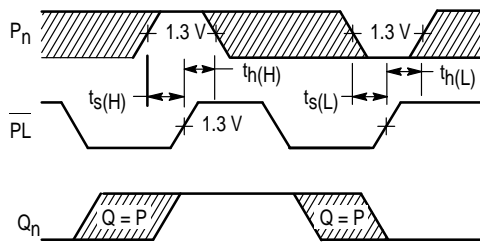

Figure 5



\* The shaded areas indicate when the input is permitted to change for predictable output performance

Figure 6

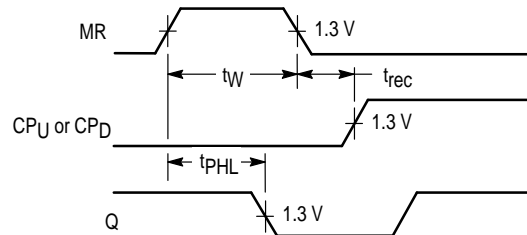

Figure 7