



575 Series Pulse Generator Operating Manual



Version 5.6

Berkeley Nucleonics Corp.
2955 Kerner Blvd.
San Rafael, CA 94901
(415) 453-9955 phone
(415) 453-9956 fax
www.berkeleynucleonics.com

1 Table of Contents

1	Table of Contents	1-2
2	Introduction	2-6
	Technical Support	2-6
	Warranty	2-6
	Package Contents	2-6
3	Safety Issues	3-7
4	Front Panel Overview	4-8
	575 Front Panel	4-8
	Display Layout and Indicators	4-8
	Description of Front-Panel Area	4-8
5	Pulse Concepts and Pulse Generator Operations	5-10
	Counter Architecture Overview	5-10
	System Timer Functions	5-10
	Channel Timer Functions	5-11
	Digital Output Multiplexer	5-11
	Dependent & Independent Timing Events	5-11
	Navigating the 575 Front Panel	5-12
	Selecting Menus	5-12
	Selecting Menu Items	5-12
	Numeric Input Mode	5-12
	Entering Non-Numeric Parameters	5-12
	Alphanumeric Input Mode	5-13
	Enabling System Output	5-13
	Enable/Disable Channel Output	5-13
	Rearming the Channel Timers	5-13
	Setting Pulse Timing Parameters	5-14
	Setting Pulse Output Parameters	5-14
	Using the Output Multiplexer	5-14
	Setting System Internal Rate Parameters	5-14
6	575 Menu Structure	6-16
	System Mode Menus (FUNC + MODE key)	6-16
	Setting System Mode of Operation	6-16
	Channel Menus (A, B, C, D, E, F, G, or H key)	6-16
	Timing Menu	6-16
	Output Configuration Menu	6-16
	Mode Menu	6-17
	Wait Menu	6-17
	Enabling Channel Output	6-17
	Setting the Channel Timing Parameters	6-17
	Setting Pulse Configuration Output Type	6-17
	Setting Channel Mode of Operation	6-17
	Delaying the Start of Channel Output	6-18
	Advanced Channel Menus (FUNC + A, B, C, D, E, F, G or H key)	6-18
	Multiplexer Menu	6-18

Configuring the Channel Multiplexer	6-18
Channel Gate Menu	6-18
Setting the Sync Source	6-18
Setting Channel Gate Control	6-18
Clocks/Rate Menus (FUNC + RATE key)	6-19
Internal Reference Menu.....	6-19
Setting the Internal Reference Source and Rate	6-19
Reference Out Menu	6-20
Setting the Output Reference	6-20
Trigger Menus (TRIG key).....	6-20
Enabling System Trigger	6-20
Gate Menus (GATE key).....	6-20
Standard Gate Menu	6-20
Enabling System Gate.....	6-21
System Configuration Menus (FUNC + SYSTEM key)	6-21
Communication Interface Menu	6-21
Setting System Communication Parameters.....	6-21
User Options Menu 1	6-21
Setting Keypad Parameters	6-21
User Options Menu 2	6-22
Setting the Auto Start Mode	6-22
Setting the Display Decimal Mark.....	6-22
Setting the Display Brightness.....	6-22
Store Menu (FUNC + STORE key).....	6-22
Storing a Configuration.....	6-22
Recall Menu (FUNC + RECALL key).....	6-23
Recalling System Configurations	6-23
Counter Menu (FUNC + AUX1 key)	6-23
Using the Counter Function.....	6-23
Information Menus (FUNC + 0 key)	6-23
Information Menu A	6-23
Information Menu B	6-23
7 Operating the 575	7-24
Quick Start - Normal Internal Rate Generator Operation.....	7-24
Quick Start - Normal External Trigger Operation	7-24
System Timer Overview	7-25
To Use Continuous Mode	7-25
To Use Single Shot Mode.....	7-25
To Use System Burst Mode Function.....	7-25
To Use System Duty Cycle Function.....	7-26
Channel Timer Overview.....	7-26
To Use Channel Normal Mode Function.....	7-26
To Use Channel Single Shot Function.....	7-27
To Use Channel Burst Mode Function	7-27
To Use the Channel Duty Cycle Function	7-27
To Use the Channel Gating Function.....	7-28

External Input Overview	7-28
To Generate a Pulse on Every Trigger Input	7-28
To Generate a Burst of Pulses on Every Trigger Input.....	7-29
To Start a Continuous Stream of Pulses Using the External Trigger	7-29
To use the External Gate to Control the System.....	7-30
8 Programming the 575	8-31
Personal Computer to Pulse Generator Communication	8-31
RS232 Interface Overview.....	8-31
USB Interface Overview	8-32
GPIB Interface Overview	8-32
Ethernet Interface Overview	8-32
Programming Command Types and Format.....	8-33
Line Termination	8-33
IEEE 488.2 Common Command Format.....	8-33
SCPI Command Format.....	8-34
SCPI Command Keywords	8-34
SCPI Command Format.....	8-34
SCPI Keyword Separator	8-34
SCPI Optional Keywords.....	8-35
SCPI Specific and Implied Channel	8-35
SCPI Parameter Types	8-35
Error Codes	8-35
Programming Examples.....	8-36
575 INSTRument Commands (SCPI Command Summary).....	8-37
575 System PULSe[0] Commands (SCPI Command Summary).....	8-38
575 Channel PULSe[n] Commands (SCPI Command Summary)	8-39
575 SYSTem Commands (SCPI Command Summary)	8-40
575 DISPlay Commands (SCPI Command Summary)	8-41
IEEE 488.2 Common Commands.....	8-41
INTERNAL RATE GENERATOR.....	A-1
PROGRAMMABLE TIMING GENERATOR	A-1
SYSTEM EXTERNAL TRIGGER/GATE INPUT(S).....	A-1
MODULE SPECIFICATIONS.....	A-2
TTL/ADJUSTABLE DUAL CHANNEL OUTPUT MODULE (Standard).....	A-2
TRIGGER INPUT	A-3
GATE INPUT	A-3
OPTICAL OUTPUTS.....	A-3
OPTICAL INPUTS.....	A-3
EXTERNAL CLOCK IN/OUT	A-3
GENERAL.....	A-3
OUTPUT MODULES	A-4
Standard	A-4
Optional.....	A-4
INPUT MODULES	A-4
Standard	A-4
Optional.....	A-4

System Options	A-4
Safety Marking Symbols.....	B-5
COM Overview.....	C-8
GPIB Interface	C-8
Ethernet Interface.....	C-8
IP Address and Raw TCP/IP Connection	C-8
Determining IP Address.....	C-8
DT15 Overview	D-10
DT15 Menus	D-10
Trigger 1 Menu (TRIG key)	D-10
Enabling System Trigger	D-10
Trigger 2 Menu (GATE key) *	D-10
DT15 SCPI Command Summary.....	D-11
DT15 IEEE 488.2 Command Summary	D-11
AT35 Description.....	E-12
AT35 Specifications.....	E-12
TZ50 Overview	F-13
TZ50 Specifications	F-13
TTL/CMOS Mode	F-13
Adjustable Mode.....	F-13
Increment Overview.....	G-14
Increment Menus	G-14
System Mode Menu 1 Extensions (FUNC + MODE key)	G-14
System Mode Menu 2 Extensions (FUNC + MODE key)	G-14
Setting System Increment Modes of Operation	G-14
Advanced Channel Menu Increment Extension (FUNC + channel key).....	G-15
Setting the Channel Increment Parameters	G-15
Increment SCPI Command Summary.....	G-15
Increment Initialization and Reset (FUNC + CLR).....	G-15
Increment Specifications.....	G-15
AT45 Option Overview	H-17
AT45 Protection Error Messages.....	H-17
Module Errors	H-17
System Limit Error	H-17
Voltage Change Timing.....	H-17
AT45 Channel Menus	H-17
Channel Output Configuration Menu	H-17
AT45 SCPI Command Extension Summary.....	H-18
AT45 Specifications.....	H-18

2 Introduction

This manual is a reference designed to familiarize you with the Berkeley Nucleonics 575 series pulse generator and is arranged so that you can easily find the information you're looking for. Generally, each topic has its own section and no section assumes that you've read anything else in the manual.

Technical Support

For questions or comments about operating the 575 -- our technical staff can be reached via one of the following methods:

- Phone: (415) 453-9955
- Fax: (415) 453-9956
- Online: www.berkeleynucleonics.com

Warranty

In addition to a 30-day money back guarantee, the 575 has a two-year limited warranty from the date of delivery. This warranty covers defects in materials and workmanship. Berkeley Nucleonics will repair or replace any defective unit. Contact us for information on obtaining warranty service.

Package Contents

The box you receive should contain the following:

- 575 Pulse Generator
- AC Power Cord
- Disc that includes
 - Operating Manual
 - Software Drivers
 - Communication Software

Contact Berkeley Nucleonics (415) 453-9955 if any parts are missing.

3 Safety Issues

Normal use of test equipment presents a certain amount of danger from electrical shock because testing must be performed where exposed voltage is present. An electrical shock causing 10 milliamps of current to pass through the heart will stop most human heartbeats. Voltage as low as 35 V (DC or RMS AC) should be considered dangerous and hazardous since it can produce a lethal current under certain conditions. Higher voltages pose an even greater threat because such voltage can easily produce a lethal current. Your normal work habits should include all accepted practices that will prevent contact with exposed high voltage, and steer current away from your heart in case of accidental contact with a high voltage. You will significantly reduce the risk factor if you know and observe the following safety precautions:





- If possible, familiarize yourself with the equipment being tested and the location of its high-voltage points. However, remember that high voltage may appear at unexpected points in defective equipment.
- Do not expose high voltage needlessly. Remove housing and covers only when necessary. Turn off equipment while making test connections in high-voltage circuits. Discharge high-voltage capacitors after shutting down power.
- When testing AC powered equipment, remember that AC line voltage is usually present on power input circuits, such as the on-off switch, fuses, power transformer, etc.
- Use an insulated floor material or a large, insulated floor mat to stand on, and an insulated work surface on which to place equipment. Make certain such surfaces are not damp or wet.
- Use the time-proven “one hand in the pocket” technique while handling an instrument probe. Be particularly careful to avoid contact with metal objects that could provide a good ground return path.
- Never work alone. Someone should always be nearby to render aid if necessary. Training in CPR first aid is highly recommended.

4 Front Panel Overview

575 Front Panel

Display Layout and Indicators

A 4 line x 20 character vacuum fluorescent display module displays parameters and status information. The status information is located in the upper-left corner of the display, between the two brackets. There are four enunciators:

-  A vertical arrow indicates there are additional pages to the current menu.
-  An alternating hollow and then solid circle indicates the unit is actively generating pulses, or armed and waiting for an external trigger.
-  A musical note indicates the function key has been pressed.
-  In external oscillator operation, a question mark indicates the internal pll is not yet locked with the external clock signal.

The upper-right side of the display contains the title of the currently displayed menu. The rest of the display is used for system parameters. The display brightness may be adjusted, allowing the instrument to be used under various lighting conditions.

Description of Front-Panel Area

Keypads

Three keypad areas provide fast access to various menus and easy editing of system parameters.

- Channel Keypad Provides one touch access to the menus for setting up the channel parameters. Pressing the appropriate letter will display the parameters for the corresponding channel. Example: Pressing the **A** key will access the Channel A menus.
- Arrow Keypad The up (**UP**) and down (**DOWN**) arrow keys are used to increment/decrement the current parameter (indicated by the blinking cursor). The position of the cursor controls the step size for each increment. The

right (**RIGHT**) and left (**LEFT**) arrow keys moves the cursor to different positions within the current parameter. The **NEXT** key selects the next parameter in the currently displayed menu.

- **Numeric Keypad** Allows numbers and alphanumeric values to be entered. When entering alphanumeric values, pressing a key will display the first letter shown on the key. The yellow **FUNC** key allows the keys to select the yellow functions.

Repeated key presses will toggle through all the letters, both upper and lower case, shown on the keycap. To enter two letters which appear on the same keycap, select the first character, then use the right arrow to shift to the next position and enter the next letter. When data entry is complete the **ENTER** key must be pressed.

Rotary Adjustment Knob

As an alternative to the Arrow Keypad, the Rotary Adjustment Knob may be used to adjust the current parameter. The step size is controlled by the position of the cursor; however turning the knob faster will increase the step size. Pushing the knob will perform functions similar to the **NEXT** key and switch to the next parameter in the currently displayed menu.

Second Level Menus (Function Key)

The second level menus (indicated in yellow above certain keys) are accessed through the use of the yellow function (**FUNC**) key. Pressing the **FUNC** key once and then pressing the desired menu key will display the specified second level menu. Pressing the **FUNC** key twice in succession will put the unit into “Function Lock” mode, where the second level menus can be accessed without repeatedly pressing the **FUNC** key. Pressing the **FUNC** key a third time will exit “Function Lock” mode.

5 Pulse Concepts and Pulse Generator Operations

Counter Architecture Overview

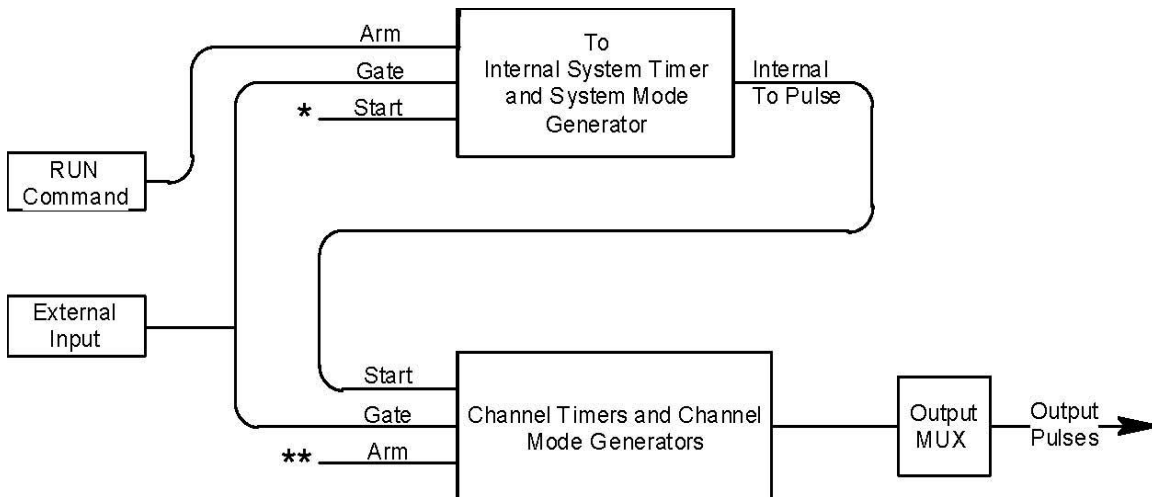

*Start source is: **RUN/STOP** key in Internal Modes
External input in External Trigger modes
*TRG command via Serial/GPIB access

**Channels are armed by the RUN button. In single shot and burst modes channels may be rearmed by pressing the RUN button.

System Timer Functions

The System Timer functions as a non-retriggerable, multi-vibrator pulse generator. This means that once started, depending on the mode, the timer will produce pulses continuously. Before pulses can be generated, the timer must be armed and then receive a start pulse. Arming the counter is done by pressing the **RUN/STOP** key. With external trigger disabled, the **RUN/STOP** key also generates the start command for the counter. With external trigger enabled, the external trigger provides the start pulse. In either case, once started, the counter operation is determined by the System Mode Generator. Standard modes include:

- Continuous Once started T_0 pulses are generated continuously.
- Single Shot One T_0 pulse is generated for each start command.
- Burst 'n' T_0 pulses are generated for each start command.
- Duty Cycle Once started T_0 pulses cycle on and off continuously.

The T_0 pulses are distributed to all of the start inputs of the Channel Timers and Mode Generators

Channel Timer Functions

The Channel Timer functions as a non-retriggerable, delayed, one shot pulse generator. This means that the timer will only generate one delayed pulse for every start pulse received. Once the channel timer has started counting, additional start pulses will be ignored until the pulse has been completed (non-retriggerable). The start pulse for each channel is provided by the internal T_0 pulse generated by the Internal System Timer. Whether or not a pulse is generated for each T_0 pulse is determined by the Channel Mode Generator. Standard modes include:

- Normal A pulse is generated for each T_0 pulse.
- Single Shot One pulse is generated at the first T_0 pulse, after which output is inhibited.
- Burst A pulse is generated for each T_0 pulse, 'n' times, after which output is inhibited.
- Duty Cycle 'n' pulses are generated for each T_0 pulse after which the output is inhibited for 'm' times. The cycle is then repeated.

Different modes may be selected for each output, allowing a wide variety of output combinations. Each output may also be independently disabled or gated (using the external gate input).

Digital Output Multiplexer

The outputs of the Channel Timers are routed to a set of multiplexers. This allows routing of any or all Channel Timers to any or all of the unit outputs. In the normal mode of operation, the output of the T_n Channel Timer is routed to the T_n output connector. As an example, if a double pulse is required on Channel A output, one can multiplex the Channel A timer with the Channel B timer adjusting each timer to provide the necessary pulses.

Dependent & Independent Timing Events

The 575 allows the user to control the relationship between the Channel Timers by setting the sync source for each timer. Independent events are all timed relative to the internal T_0 start pulse. Dependent events may be linked together by setting the sync source to the controlling event. This allows the instrument to match the timed events and adjustments can be made in one event without detuning the timing between it and a dependent event.

Navigating the 575 Front Panel

Selecting Menus

Parameters are grouped in menus, selectable using menu keys. To select the output channel parameters press the letter key corresponding to the desired channel. To select second level menus press the **FUNC** key and then the key corresponding to the desired function. To select advanced channel menus press the **FUNC** key followed by the desired channel key. Menus may include a number of different pages with each page containing up to four parameters. The status block in the upper-left corner of the display shows a vertical arrow if the current menu contains additional pages. To select the next page, press the channel button again or select the same second level menu by pressing the **FUNC** key and the channel/menu key again.

Selecting Menu Items

Within a menu, the blinking cursor indicates the current menu item for editing. The **NEXT** key or pressing the adjustment knob will select a different menu item.

Numeric Input Mode

When the current item is numeric, the system enters the Numeric Input Mode. In this mode data may be edited in one of three ways. Using the arrow keypad, the left (**LEFT**) and right (**RIGHT**) arrow keys are used to select a digit to edit. The selected digit blinks to identify itself as the active digit. The **UP** and **DOWN** arrow keys are then used to increment or decrement this digit. Alternately, after using the **LEFT** and **RIGHT** arrow keys to select an active digit, the adjustment knob may be used to increment and decrement this digit. The adjustment knob features speed dependent resolution. Slow rotation will increment or decrement the active digit by one. As you increase the speed of rotation, the parameter will be 10 to 1000 times faster depending on the speed.

An additional entry mode is using the numeric keypad. Enter the number, including decimal point using the numeric keypad. Complete the number using the **ENTER** key. To clear number entry and/or start over press the clear key (**CLR**). Pressing the **CLR** key a second time will exit the numeric keypad mode and restore the original number.

The last entry mode is a modified form of scientific notation. The **FUNC** button acts as $10^$ in this case. Type in the value followed by **FUNC** then the number button that represents the power desired. For example 64us is entered as 6, 4, **FUNC**, and then 6.

Entering Non-Numeric Parameters

When the current item is non-numeric, the **UP** and **DOWN** arrow keys are used to select among different options for the parameter. The adjustment knob may also be used to change the selection. If the item is an on-off toggle, the **UP** arrow

(CW adjustment knob) enables the item and the **DOWN** arrow (CCW adjustment knob) disables the item.

Alphanumeric Input Mode

When the current item is alphanumeric, the system enters the Alphanumeric Input Mode. In this mode, data is entered using the alphanumeric keypad. Pressing a key will display the first letter shown on the keypad. Repeated key presses will toggle through all the letters, both upper and lower case, shown on the key cap. To enter two letters which appear on the same key cap, select the first character, then use the right arrow to shift to the next position and enter the next letter. The Left and Right arrow keys may be used to position the cursor to edit any character. When data entry is complete, the **ENTER** key must be pressed. The keys contain the following characters:

- 1 1 2 3 4 5 6 7 8 9 0
- 2 A B C a b c 2
- 3 D E F d e f 3
- 4 G H I g h i 4
- 5 J K L j k l 5
- 6 M N O m n o 6
- 7 P Q R S p q r s 7
- 8 T U V t u v 8
- 9 W X Y Z w x y z 9
- 0 0 1 2 3 4 5 6 7 8 9
- . . , # \$ % & ? • -- + * / space

Enabling System Output

The **RUN/STOP** key is used to arm the system. With external trigger disabled, the key will arm and start pulse output. With external trigger enabled, the key will arm the pulse generator. Pulse output then starts after the first valid trigger input. Pressing the **RUN/STOP** key a second time disables the pulse generator.

Enable/Disable Channel Output

At the top of each channel menu page is a parameter to enable or disable the output of the channel. Each channel may be individually enabled or disabled. An illuminated channel key indicates that the channel is enabled.

Rearming the Channel Timers

In the channel single shot mode and burst mode, the Channel Timers may be rearmed after completing the initial output by pressing the **FUNC** key followed by the **RUN/STOP** key. If there are channels currently running in normal mode, single shot and burst channels can be re-armed without affecting the timing on normal mode channels by pressing function **RUN/STOP**.

Setting Pulse Timing Parameters

Pulses are defined by a delay, from their sync or start pulse to the active edge, and a width.

Wid: Sets the width of the active portion of the pulse.
Dly: Sets the delay from the sync source to the start of the pulse.

NOTE: If $Wid + Dly + 75\text{ ns}$ (hardware reset time) $> T_0$ Period, the correct pulse width will be generated but at a slower rate.

Setting Pulse Output Parameters

There are three basic types of outputs available on the 575: (a) TTL/CMOS compatible outputs; (b) adjustable amplitude outputs; (c) optical outputs.

Out: Selects between TTL/CMOS mode and Adjustable mode when both are available on a single output.
Pol: Sets the voltage polarity of the pulse, active high or active low. Note: All outputs are positive - negative voltages are not supported.
Ampl: In adjustable mode, it sets the unloaded output voltage. The actual output voltage will depend on the load impedance. For example: If the load is 50 ohms, the output will be 50% of the stated voltage.

Using the Output Multiplexer

Each output channel includes a multiplexer which allows routing any or all of the timer outputs to the physical output. This allows double pulses and other complex pulse trains to be generated. Only timing parameters are multiplexed together, not amplitudes.

Mux: -HGFEDCBA-
 -00000101-

The multiplexer is represented by an “n” bit binary number as shown above. “n” is the number of channels. Each bit represents a channel timer, which is enabled by setting the bit to one. In the above example, timers A and C are combined on the current output.

Setting System Internal Rate Parameters

The internal T_0 period controls the fundamental output frequency of the system. Each channel may operate at submultiples of the fundamental frequency using their duty cycle mode.

Source: Sets the reference source for the internal T Period.
Per: Sets the internal T Period.

To set the system Internal Rate - press the yellow **FUNC** key, then press the **RATE** key, and then use the dial or number pad to specify the T_0 Period.

6 575 Menu Structure

System Mode Menus (FUNC + MODE key)

MODE: Continuous	MODE: Single Shot	MODE: Burst	MODE: Duty Cycle
		#/Burst	#/On
			#/Off

Setting System Mode of Operation

The **MODE** menu sets the T₀ system timer mode. The menu will show the extra set parameters (Burst, On & Off) only when they are appropriate.

- Mode: Selects the T₀ mode: Continuous, Single Shot, Burst or Duty Cycle mode.
- Burst: Sets the number of pulses to be generated when in Burst mode.
- On: Sets the number of pulses to be generated during each on cycle.
- Off: Sets the number of pulses to skip each during off cycle when in the Duty Cycle mode.

*NOTE: Any mode may be started by either the **RUN/STOP** key in the internal trigger mode or armed by the **RUN/STOP** key and started by an external trigger in the external trigger mode. In the single shot and burst modes, (internally triggered) the unit disarms itself at the end of the pulse train. Pressing the **RUN/STOP** key after the unit has been disarmed will generate a new pulse train.

Channel Menus (A, B, C, D, E, F, G, or H key)

Timing Menu

Channel Enable
Sync Source
Pulse Width
Delay

Output Configuration Menu

Channel Enable	Channel Enable	Channel Enable	Channel Enable	Channel Enable
Output Type: TTL/CMOS	Output Type: Adjustable	Output Type: Optical	Output Type: High Z	Output Type: Low Z
Polarity	Polarity	Polarity	Polarity	
	Output Level		Output Level	Output Level

Mode Menu

Channel Enable	Channel Enable	Channel Enable	Channel Enable
Mode: Normal	Mode: Single Shot	Mode: Burst	Mode: Duty Cycle
			#/On Pulses
		#/Burst Pulses	#/Off Pulses

Wait Menu

Channel Enable
#/Wait Pulses

Enabling Channel Output

At the top of each of the channel menu pages is a parameter to enable or disable the channel. Each channel may be individually controlled. When enabled, the channel key will illuminate.

Setting the Channel Timing Parameters

To define a pulse requires two parameters: the delay to the active edge and the width of the pulse.

- Wid: Sets the channel pulse width.
Dly: Sets the channel delay until the active edge.

Setting Pulse Configuration Output Type

The 575 supports two types of outputs: a high speed TTL/CMOS compatible output and for applications which require different voltage levels or higher current, an adjustable voltage output. The pulses can also be defined to be active high or active low.

- Out: Selects the output mode; TTL/CMOS, Adjustable, Optical, High Impedance (Hi Z), or Low Impedance (Lo Z)
Pol: Sets the pulse polarity, active high or active low.
Ampl: Sets the output voltage level when in the Adjustable mode.

Setting Channel Mode of Operation

Each channel may be set independently to operate in one of four modes: normal, single shot, burst, or duty cycle (within the CHANNEL menus):

- Mode: Selects the mode for the current channel. Additional parameters are provided for the burst mode and the duty cycle mode.
Brst: Sets the number of pulses in the burst mode to generate before inhibiting output.

- On: Sets the number of pulses to generate before inhibiting output in Duty Cycle Mode.
- Off: Sets the number of pulses to inhibit before repeating the On Cycle in Duty Cycle Mode.

Delaying the Start of Channel Output

Within any channel mode, the output of the channel can be delayed using the wait parameter (within the CHANNEL menu):

- Wait: Sets the number of T₀ pulses to wait until enabling the channel output.

Advanced Channel Menus (FUNC + A, B, C, D, E, F, G or H key)

Multiplexer Menu

-HGFE DCBA-
Multiplexed Channels

Configuring the Channel Multiplexer

To define which channels are fed into the channel multiplexer, the corresponding bit for the desired channel to add should be set to 1. All desired omitted channels should have the corresponding bit set to 0.

- Mux: Enable/disable bit field.

Channel Gate Menu

Channel Enable	Channel Enable	Channel Enable
Ch Gate Mode: (Gate Menu)	Ch Gate Mode: Pulse Inhibit	Ch Gate Mode: Output Inhibit
	Logic Level	Logic Level

Setting the Sync Source

Although each channel receives its start pulse from the internal T₀ pulse, the start pulse can be assigned such that the delay entered is relative to the T₀ pulse or any other channel pulse. This allows dependent events to link. The unit will not allow a circular chain of sync sources that would result in a channel triggering itself. The delay entered is relative to the selected sync source.

- Sync Source: Selects the channel sync source.

Setting Channel Gate Control

When the global gate is set (Chan Menu), the channel can then use the gate input with independent behavior from other channels.

Gate: Enables the GATE input for the channel by setting the method of output control used with the gating function.

Logic: Sets the logic level used with the gating function, either active high or active low.

“Pulse Inhibit” method

The gate prevents the channel from being triggered by the channel’s trigger source pulse. If a pulse has already started when the gate disables the channel, the pulse will continue normal output but will not restart on the next trigger pulse.

“Output Inhibit” method

The gate leaves the base triggering alone and enables/ disables the output directly.

Clocks/Rate Menus (FUNC + RATE key)

Internal Reference Menu

Source: System Osc	Source: 10MHz Ext	Source: 20MHz Ext	Source: 25MHz Ext	Source: 40MHz Ext
T ₀ Period	T ₀ Period	T ₀ Period	T ₀ Period	T ₀ Period

Source: 50MHz Ext	Source: 80MHz Ext	Source: 100MHz Ext
T ₀ Period	T ₀ Period	

Setting the Internal Reference Source and Rate

Source: Selects the internal or external clock source from which the unit will operate.

To: Sets the T₀ period which determines the fundamental output frequency of the unit.

Reference Out Menu

Ref Out: T ₀ Pulse	Ref Out: 100MHz	Ref Out: 50MHz	Ref Out: 33.33MHz	Ref Out: 25MHz
T ₀ Period	T ₀ Period	T ₀ Period	T ₀ Period	T ₀ Period

Ref Out: 20MHz	Ref Out: 16.67MHz	Ref Out: 14.2857MHz	Ref Out: 12.5MHz	Ref Out: 11.11MHz
T ₀ Period	T ₀ Period	T ₀ Period	T ₀ Period	T ₀ Period

Ref Out: 10MHz
T ₀ Period

Setting the Output Reference

Ref Out: Selects the frequency of the output reference for syn-chronizing with external system components.

Trigger Menus (TRIG key)

Mode: Disabled	Mode: Triggered
	Threshold Level
	Trigger Edge

Enabling System Trigger

Enable the use of the TRIG input by the system timer as a trigger source.

Mode: Selects between disabling/enabling the trigger mode.
Level: Sets the trigger threshold. Edge: Selects between rising and falling edges as the trigger source when a trigger mode is enabled.

Gate Menus (GATE key)

Standard Gate Menu

Mode: Disabled	Mode: Pulse Inhibit	Mode: Output Inhibit	Mode: (Chan Menu) *
	Threshold Level	Threshold Level	Threshold Level
	Logic Level	Logic Level	

* Gate Mode is controlled on a per channel basis from the [Advanced Channel Gate Menu](#)

Enabling System Gate

Enables the use of the GATE input as a trigger inhibit or output control for all channels simultaneously, or on a per channel basis.

Mode: Selects between disabling the GATE inputs and method of output control
Level: Sets the gating threshold.
Logic: Sets the active logic level.

System Configuration Menus (FUNC + SYSTEM key)

Communication Interface Menu

Interface: RS232	Interface: USB	Interface: GPIB *	Interface: Ethernet *
Baud Rate		Address	
Echo			

* Instrument must be equipped with the Extended Communications Option.
(Visit www.berkeleyelectronics.com for more details).

Setting System Communication Parameters

The 575 comes with a standard RS232 serial port and USB port. The unit will not respond to computer commands unless these ports are properly configured.

Interface: RS232, USB, GPIB (optional), Ethernet (optional)
Baud Rate: Selects the baud rate for the selected interface.
Echo: Selects whether to echo characters back to the host computer or not. Address: Sets the GPIB address.

User Options Menu 1

Key Rate
Key Volume
Knob Volume

Setting Keypad Parameters

The rate at which a key will repeat itself when held down may be set. This can be used to provide a controlled rate at which a parameter is incremented. In addition, the volume of the beep can be controlled for both the keypad and the adjustable knob.

Key Rate: Sets the rate at which the keys will repeat when held down.
Key Vol: Sets the beep volume for the keypad.
Knob Vol: Sets the beep volume for the Rotary Knob.

Recall Menu (FUNC + RECALL key)

Configuration #
Name
Help Line

Recalling System Configurations

Use the following procedure to recall a stored or default system configuration:

- Enter the Recall Menu (**FUNC + RECALL**).
- Select a configuration number.
- From the Recall Menu, press the recall key sequence (function + recall).

*Note: Configuration 0 is the factory default setting.

Counter Menu (FUNC + AUX1 key)

Counter Enable	Counter Enable		
T Counts	T Counts		
	G Counts *		
Help Line	Help Line		

* Enabled when the Trigger Mode is set to Dual Trigger operation (Instrument must be equipped with the Dual Trigger Option. Visit www.berkeleyelectronics.com for more details).

Using the Counter Function

The Counter function counts the number of T_0 pulses output by the system clock. When the unit is operated in system single shot mode, the T_0 count reflects the number of incoming trigger pulses.

Information Menus (FUNC + 0 key)

Information Menu A

Model Number
Serial Number
Firmware Ver.
FPGA Ver.

Information Menu B

FW ID #
GA ID #
Module IDs
Instr. Options

The Information Menus provide all of the pertinent version numbers and serial numbers for the unit. This information should be readily available when contacting customer service for troubleshooting help.

7 Operating the 575

Quick Start - Normal Internal Rate Generator Operation

The 575 has a powerful set of functions providing a number of modes of operation for the internal or “System” rate generator (T_0). Most of these functions can be ignored if a simple continuous stream of pulses is required. Starting from the default settings, which can be restored by recalling configuration 0, the following parameters need to be set:

Pulse Width, Delay	Enter the Channel menus by pressing the letter key. Enter the required pulse width and delay. Repeat for each output channel.
T_0 Period	Enter the Rate menu by pressing the FUNC key and then the RATE key. Set the desired pulse period. Note that in general, the pulse delay plus the pulse width, plus a 75ns hardware reset constant, for any channel must be less than the T_0 period.
Start	Press the RUN/STOP key to start generating pulses.
Stop	Press the RUN/STOP key a second time to stop generating pulses.

Quick Start - Normal External Trigger Operation

To generate a single pulse for every external trigger event, based on the default configuration 0, the following parameters need to be set:

System Mode	Enter the System Mode menu by pressing the FUNC key and then the MODE key. Select Single Shot mode.
Trig	Enter the Trigger menu by pressing the TRIG key. Select Triggered.
Level	Press the NEXT key until the Level parameter is highlighted. Set the trigger threshold voltage to approximately 50% of the trigger signal amplitude.
Edge	Press the NEXT key until the Edge parameter is highlighted. Set the instrument to trigger off the rising edge or falling edge as desired.

Pulse Width, Delay	Enter the Channel menus by pressing the letter key. Enter the required pulse width and delay. Repeat for each output channel.
Start	Press the RUN/STOP key to start/arm the instrument. The 575 will now generate a pulse for every valid trigger.
Stop	Press the RUN/STOP key a second time to stop/dis-arm the instrument (i.e. to stop generating pulses).

System Timer Overview

For internal operation, the 575 contains a timer and mode generator which generates an internal T_0 clock that is used to trigger all the channel timers. System modes are controlled via the MODE menu.

To Use Continuous Mode

The RUN/STOP button starts and stops a continuous pulse stream at the rate specified by the Rate menu. This corresponds to the normal output mode for most pulse generators.

To generate a continuous stream of pulses:

- within the system Mode menu
Mode Select Continuous for the system mode.
- within the Rate menu
Source Select the system oscillator or the external clock in frequency.
- Period Set the desired period.

Pressing the **RUN/STOP** key will now generate a stream of T_0 pulses at a rate specified by the period parameter.

To Use Single Shot Mode

To generate a single pulse with every press of the **RUN/STOP** key:

- within the system Mode menu
Mode Select Single Shot for the system mode.

Pressing the **RUN/STOP** key will now generate a single pulse.

To Use System Burst Mode Function

The RUN/STOP button generates a stream of “n” T_0 pulses, where “n” is specified by the Burst parameter. The rate is specified in the Rate menu.

Pressing the RUN/STOP button while the burst is in process will stop the output. After the burst has been completed, pressing the RUN/STOP button will generate another burst. T_0 generate a burst of pulses:

- within the system Mode menu
- Mode: Select the Burst mode.
- Burst: Set the number of pulses to produce in the burst.

To Use System Duty Cycle Function

The RUN/STOP button starts a continuous pulse stream which oscillates on for the “n” pulses and off for “m” pulses, where “n” and “m” are specified by the On and Off parameters, respectively. The rate is specified in the Rate Menu. To generate a stream of pulses which oscillates on for ‘n’ pulses and off for ‘m’ pulses:

- within the system Mode menu
- Mode: Select the Duty Cycle mode.
- On: Set the number of pulses to produce during the on cycle.
- Off: Set the number of pulses to skip during the off cycle.

- within the Rate menu
- Source: Select the system oscillator or the external clock in frequency.
- Period: Set desired Period.

Channel Timer Overview

The output of each channel is controlled by two timers to generate the delay timing and the pulse width. All channels are simultaneously triggered, depending on the system mode, by the internal T_0 pulse, the external trigger, or a trigger provided by the operating software. A given channel may or may not generate a pulse depending on its own channel mode as described below.

When one channel is generating a continuous stream of pulses, a user can trigger a single shot or burst of pulses on another channel without interrupting the continuous stream by pressing the **FUNC** and the **RUN/STOP** key.

To Use Channel Normal Mode Function

The Normal mode generates a continuous stream of pulses at a rate determined by the system timer:

- within the Channel menus
- Enable: Select Enable to enable channel output.
- Dly: Set the desired delay.
- Wid: Set the desired pulse width.

Mode: Select the Normal mode.
Pressing the **RUN/STOP** key will now generate a continuous stream of pulses.

To Use Channel Single Shot Function

The Single Shot mode generates a single pulse every time the **RUN/STOP** key is pressed. If the unit is in the active state, (i.e. channels which are set to the Normal mode are producing pulses), pressing the **FUNC** key and **RUN/STOP** key will reset the Single Shot counters and generate one pulse in sync with the other channels running in the Normal mode. To use the Single Shot mode:

- within the Channel menus
- Enable: Select "Enabled" to enable channel output.
- Delay: Set the desired delay.
- Width: Set the desired pulse width.
- Mode: Select the Single shot mode.

To Use Channel Burst Mode Function

The Burst mode generates a burst of pulses every time the **RUN/STOP** key is pressed. If the unit is in the active state, (i.e. channels which are set to the Normal mode are producing pulses), pressing the **FUNC - RUN/STOP** key sequence will reset the Burst counters and generate a new set of pulses in sync with the other channels running in the Normal mode. **FUNC - RUN/STOP** will not affect T_0 pulse status. To use the Burst mode:

- within the Channel menus
- Enable: Select "Enabled" to enable channel output.
- Delay: Set the desired delay.
- Width: Set the desired pulse width.
- Mode: Select the Burst mode.
- #/Burst: Set the number of pulses to produce in the burst.

To Use the Channel Duty Cycle Function

To generate a stream of pulses which oscillates on for 'n' pulses and off for 'm' pulses:

- within the Channel menus
- Enable: Select "Enabled" to enable channel output.
- Delay: Set the desired delay.
- Width: Set the desired pulse width.
- Mode: Select the Duty Cycle mode.
- On Cycle: Set the number of pulses to produce during the on cycle.
- Off Cycle: Set the number of pulses to skip during the off cycle.

**Note: Older Berkeley Nucleonics pulse generators had a divide-by-n function. The duty cycle mode is a more general case. To reproduce the divide-by-n*

function, set the on cycle to 1 and set the off cycle to (n-1), where “n” is the divide-by-n factor.

To Use the Channel Gating Function

Each channel may use the external input to gate or control its output. The gate controls the triggering of the channel. To use the gate, set the following parameters

- within the Channel menu

Mode: In Gate Menu must be set to Channel Menu.

Channel Gate: Select “Pulse Inh” or “Output Inh”.

Logic: Select active high or active low.

In the “Pulse inhibit” method, the gate prevents the channel from being triggered by the channel’s trigger source pulse. If a pulse has already started when the gate disables the channel, the pulse will continue normal output but will not restart on the next pulse. In the “Output inhibit” method, the gate leaves the base triggering alone and enables/disables the output directly. Output pulses will immediately cease when the gate signal is removed

External Input Overview

The external inputs may be used to trigger the unit or to gate the system or channel timers. When using a trigger input, the external input acts as a system start pulse. Depending on the system mode, the result of a trigger input can be either a single pulse, a burst of pulses or the start of a stream of pulses.

To Generate a Pulse on Every Trigger Input

To generate a pulse on every external trigger received, set the following parameters:

- within the Mode menu

Mode: Select the Single Shot mode.

- within the Trigger menu

Mode: Select Triggered mode.

Level: Set the trigger threshold level.

Edge: Select which edge, rising or falling, to trigger on.

Pressing the **RUN/STOP** key will arm the unit. Once the unit is armed, it will generate a T_0 pulse for every external trigger received. Pressing the **RUN/STOP** key will disarm the unit. This mode corresponds to the normal external trigger mode found on most other pulse generators.

To Generate a Burst of Pulses on Every Trigger Input

To generate a burst of pulses for every external trigger received set the following parameters:

- within the Mode menu

Mode: Select the Burst mode.

Burst: Set the number of pulses to generate in each burst.

- within the Rate menu

To: Set the period between pulses.

- within the Rate menu

Source: Select the system oscillator or an external clock in frequency.

To: Set the period between pulses.

- within the Trigger menu

Mode: Select Triggered mode.

Level: Set the trigger threshold level.

Edge: Select which edge, rising or falling, to trigger on.

Pressing the **RUN/STOP** key will arm the unit. Once the unit is armed, it will generate a set of pulses for every external trigger received. The unit is reset at the end of a burst and will generate another set of pulses upon receiving a new trigger. Triggers that occur in the middle of a burst are ignored. Pressing the **RUN/STOP** key will disarm the unit.

To Start a Continuous Stream of Pulses Using the External Trigger

The external trigger may be used to start the unit generating pulses:

- within the Mode menu

Mode: Select the Continuous mode.

- within the Rate menu

Source: Select the system oscillator or an external clock in frequency.

To: Set the period between pulses.

- within the Trigger menu

Mode: Select the Trigger mode.

Level: Set the trigger threshold level.

Edge: Select which edge, rising or falling, to trigger on.

Pressing the **RUN/STOP** key will arm the unit. Once the unit is armed, it will begin generating pulses after an external trigger is received. Triggers

that occur after the pulses start are ignored. Pressing the **RUN/STOP** key a second time will disarm the unit.

To use the External Gate to Control the System

The external gate may be used to control the output of the unit. To gate the system timer:

- within the Mode menu

Mode: Select the desired mode.

- within the Rate menu

Source: Select the system oscillator or an external clock in frequency.

Per: Set the period between pulses.

- within the Gate menu

Mode: Select "Pulse Inh" or "Output Inh".

Level: Set the gate threshold level.

Logic: Select active high or active low.

Pressing the **RUN/STOP** key will arm the unit. Once the unit is armed, it will begin generating pulses whenever the external gate input is in the active state. Pressing the **RUN/STOP** key a second time will disarm the unit.

8 Programming the 575

Personal Computer to Pulse Generator Communication

The 575 ships standard with an RS232 serial and USB interface. Ethernet and GPIB interfaces are available as an option. All menu settings can be set and retrieved over the computer interface using a simple command language. The command set is structured to be consistent with the Standard Commands for Programmable Instruments. Although due to the high number of special features found in the 575, many of the commands are not included in the specification. The syntax is the same for all interfaces. The amount of time required to receive, process, and respond to a command at a Baud rate of 115200 is approximately 10 ms. Sending commands faster than 10 ms may cause the unit to not respond properly. It is advised to wait until a response from the previous command is received before sending the next command.

WARNING: When communicating with the unit (USB, Serial or Ethernet), avoid sending any commands that include the “*” character as the unit is booting up. This may result in an undesired lockup of the instrument.

RS232 Interface Overview

The serial port is located on the back of the 575 and uses a 9-pin D-type connector with the following pinout (as viewed from the back of the unit):

1	No Connection
2	Tx - Transmit (to computer)
3	Rx - Receive (from computer)
4	DTR - Connected to pin 6
5	Ground
6	DSR - Connected to pin 4
7	RTS - Connected to pin 8
8	CTS - Connected to pin 7
9	No Connection

The serial port parameters should be set as follows:

Baud Rate	4800, 9600 19200, 38400, 57600, 115200*
Data Bits	8
Parity	None
Stop Bits	1

*The default baud rate for the RS232 is 115200.

USB Interface Overview

The USB interface is standard on the 575. Before this type of communication can be used, the appropriate drivers must be installed on the personal computer (pc). These drivers are included on the CD that was shipped with your unit. Please contact Berkeley Nucleonics or visit www.berkeley-nucleonics.com for updated installation files and instructions.

USB communication is achieved by using a mapped (virtual) COM port on the PC. The driver installation executable will obtain an unused COM port number, install the USB drivers, and make that COM port number available for typical RS232 communication to the pulse generator. HyperTerminal or other common software may be used.

When communicating through the mapped COM port over USB, the baud rate for the communication port used by the USB chip must match the baud rate for the COM port on the PC. Access to the USB port baud rate is done using the SCPI command “:SYSTEM:COMMunicate:SERial:USB <baud rate>” command. This parameter can be accessed via any communication method. The default baud rate for USB is 38400.

USB communication notes:

- The correct drivers must be installed on the personal computer before communication can be accomplished via USB.
- The BAUD rates on the PC and on the pulse generator must match for successful communication.
- The USB port’s BAUD rate on the pulse generator can be set using the SCPI command “:SYSTEM:COMMunicate:SERial:USB <baud rate>” where <baud rate> can be:
 - 4800
 - 9600
 - 19200
 - 38400 (default)
- USB 1.0 specification is used. The USB cable can be removed without “unplugging” the device in the operating system environment.
- Echo functionality is not available on the USB port.

GPIB Interface Overview

A GPIB interface is optional on the 575. Refer to [Appendix C](#) for more information.

Ethernet Interface Overview

An Ethernet interface is optional on the 575. Refer to [Appendix C](#) for more information.

Programming Command Types and Format

The 575 Pulse Generator uses two types of programming commands: IEEE 488.2 Common Commands and Standard Commands for Programmable Instruments (SCPI). The format is the same for all interfaces. HyperTerminal (in Windows) or any other generic terminal program may be used to interactively test the commands using the RS232 interface. The format of each type is described in the following paragraphs.

Line Termination

The pulse generator uses text-style line terminations. When a command is sent to the unit, the firmware is programmed to read characters from a communication port until it reads the line termination sequence.

The command string is parsed and executed after reading these characters. These characters are the “carriage return” and “linefeed”. They are ASCII character set values 13 and 10 respectively (hex 0x0D and 0x0A). All command strings need to have these characters appended.

When the pulse generator responds to a command, whether it is a query or a parameter change, it also appends its return strings with these characters. Coded applications could use this behavior to know when to stop reading from the unit. However, if the “echo” parameter is enabled, there will be two sets of line terminators, one following the echoed command string, and one following the pulse generator’s response.

Note: The pulse generator will echo commands on the DB9 serial port only.

The pulse generator responds to every communication string. If the communication string is a query, the unit responds with the queried response (or error code) followed by the line terminators. If the communication string is a parameter change, the response is “ok” (or error code) followed by the line terminators. For this reason, it is not recommended that multiple commands be stacked together into single strings as is common with some other types of instruments. It is recommended that the coded application send a single command in a string and follow immediately by reading the response from the unit. Repeat this sequence for multiple commands.

IEEE 488.2 Common Command Format

The IEEE 488.2 Common Commands control and manage generic system functions such as reset, configuration storage and identification. Common commands always begin with the asterisk (*) character and may include parameters. The parameters are separated from the command mnemonic by a space character. For Example:

```
*RST<cr><lf>  
*RCL 1<cr><lf>
```

*IDN?<cr><lf>

SCPI Command Format

SCPI Command Keywords

The commands are shown as a mixture of upper and lower case letters. The upper case letters indicate the abbreviated spelling for the command. You may send either the abbreviated version or the entire keyword. Upper and/or lower case characters are acceptable.

For example, if the command keyword is given as POLarity, then POL and POLARITY are both acceptable forms; truncated forms such as POLAR will generate an error; polarity, pol, and PolAriTy are all acceptable as the pulse generator is not case sensitive.

SCPI Command Format

SCPI commands control and set instrument specific functions such as setting the pulse width, delay and period. SCPI commands have a hierarchical structure composed of functional elements that include a header or keywords separated with a colon, data parameters, and terminators. For example:

SCPI Format

```
:PULSE1:STATE ON<cr><lf>
:PULSe1:WIDTh 0.000120<cr><lf>
:PULSe:POL NORMAl<cr><lf>
```

Any parameter may be queried by sending the command with a question mark appended. For example:

- QUERY FORMAT

```
:PULSE1:STATE?<cr><lf>
    Will return:  1<cr><lf>

:PULSE1:WIDT?<cr><lf>
    Will return:  0.000120000<cr><lf>

:PULSE1:POL?<cr><lf>
    Will return:  NORM<cr><lf>
```

SCPI Keyword Separator

A colon (:) must always separate one keyword from the next lower-level key-word. A space must be used to separate the keyword header from the first parameter. If more than one parameter is used, you must separate subsequent parameters with a comma.

SCPI Optional Keywords

Optional keywords and/or parameters appear in square brackets ([]) in the command syntax. Note that the brackets are not part of the command and should not be sent to the pulse generator. When sending a second level key-word without the optional keyword, the pulse generator assumes that you intend to use the optional keyword and responds as if it had been sent.

SCPI Specific and Implied Channel

Some commands, such as PULSe, allow specifying a channel with an optional numeric keyword suffix. The suffix will be shown in square brackets [1 / 2]. The brackets are not part of command and are not to be sent to the pulse generator. The numeric parameters correspond to the following channels: 0 = T₀, 1 = ChA, 2 = ChB, etc. Only one channel may be specified at a time.

If you do not specify the channel number, the implied channel is specified by the :INSTrument:SElect command or the last referenced channel.

After power-up or reset (*RST) the instrument default is channel #1.

SCPI Parameter Types

The following parameter types are used:

<numeric value>	Accepts all commonly used decimal representation of numbers including optional signs, decimal points, and scientific notation: 123, 123e2, -123, -1.23e2, .123, 1.23e-2, 1.2300E-01.
<boolean value>	Represents a single binary condition that is either true or false. True is represented by a 1 or ON; false is represented by a 0 or OFF. Queries return 1 or 0.
<identifier>	Selects from a finite number of predefined strings.

Error Codes

The unit responds to all commands with either:
ok<cr><lf> or ?n<cr><lf>

Where "n" is one of the following error codes:

- 1 Incorrect prefix, i.e. no colon or * to start command.
- 2 Missing command keyword.
- 3 Invalid command keyword.
- 4 Missing parameter.
- 5 Invalid parameter.
- 6 Query only, command needs a question mark.
- 7 Invalid query, command does not have a query form.
- 8 Command unavailable in current system state.

Programming Examples

Example 1)

20 ms pulse width, 2.3 ms delay, 10 Hz, internal trigger, continuous operation.

:PULSE1:STATE ON<cr><lf>	enables channel A
:PULSE1:POL NORM<cr><lf>	sets polarity to active high
:PULSE:WIDT 0.020<cr><lf>	sets pulse width to 20 ms
:PULSE1:DELAY 0.0023<cr><lf>	sets delay to 2.3 ms
:PULSE0:MODE NORM<cr><lf>	sets system mode to continuous
:PULSE0:PER 0.1<cr><lf>	sets period to 100 ms (10 Hz)
:PULSE0:TRIG:MODE DIS<cr><lf>	disables the external trigger

To start the pulses use either of the following commands:

:PULSE0:STATE ON<cr><lf>	starts the pulses
:INST:STATE ON<cr><lf>	alternate form to start pulses

Example 2)

25 μ s pulse width, 0 delay, external trigger, one pulse for every trigger.

:PULSE1:STATE ON<cr><lf>	enables channel A
:PULSE1:POL NORM<cr><lf>	sets polarity to active high
:PULSE:WIDT 0.000025<cr><lf>	sets pulse width to 25 μ s
:PULSE1:DELAY 0<cr><lf>	sets delay to 0
:PULSE0:MODE SING<cr><lf>	sets system mode to single shot
:PULSE:TRIG:MODE TRIG<cr><lf>	sets system to external trigger
:PULS:TRIG:LEV 2.5<cr><lf>	sets trigger level to 2.5 v
:PULS:TRIG:EDGE RIS<cr><lf>	set to trigger on rising edge

To arm the instrument in external gate mode, use either of the following commands:

:PULSE0:STATE ON<cr><lf>	arms the instrument
:INST:STATE ON<cr><lf>	alternate form if T ₀ is currently selected

A software generated external trigger can be generated by using the following command:

*TRG<cr><lf>	generates a software external trigger
--------------	---------------------------------------

575 INSTRument Commands (SCPI Command Summary)

Keyword	Parameter	Comments
:INSTRument		Subsystem. Supports treating each channel as a logical instrument.
:CATalog?		Query only. Returns a comma-separated list of the names of all channels. A two channel instrument would return: T0,CHA,CHB.
:FULL?		Query only. Returns a comma-separated list of the names of all channels and their associated number. A two channel instrument would return: T ₀ , 0, CHA, 1, CHB, 2.
:COMMands?		Query only. Returns an indented list of all SCPI commands.
:NSElect	0-8	Selects a channel using the channel's numeric value. All channel specific commands will refer to the selected channel.
:SElect	T0,CHA,CHB,CHC,CHD, CHE,CHF,CHG,CHH	Selects a channel using the channel's identifier string. All subsequent channel specific commands will refer to the selected channel.
:STATe	0/1 or ON/OFF	Enables/Disables the selected channel output. If T ₀ is selected all output is affected. Enabling T ₀ is the same as pressing the RUN button.

575 System PULSe[0] Commands (SCPI Command Summary)

Keyword	Parameter	Comments
:PULSe[0]		Subsystem. Contains commands to control the output pulse generation. Commands without suffix refer to the currently selected logical instrument. See INSTRUMENT subsystem.
:COUNter		Subsystem. Contains commands to define the Counter function.
:STATe	0/1 or ON/OFF	Enables/Disables the counter function.
:CLear	TCNTS/GCNTS	Clears the designated counter. Standard units only have the Trigger counter.
:COUNts	TCNTS/GCNTS	Queries the number of counts for the specified input. Standard units only have the Trigger counter.
:STATe	0/1 or ON/OFF	Enables / Disables the output for all channels. Command is the same as pressing the RUN/STOP button.
:PERiod	100ns-5000s	Sets the T ₀ period.
:MODE	NORMal / SINGLE / BURSt / DCYCLE	Sets the T ₀ mode.
:BCounter	1-9,999,999	Burst Counter. Number of pulses to generate in the Burst mode.
:PCounter	1-9,999,999	Pulse Counter. Number of pulses to generate during on cycle of the Duty Cycle mode.
:OCounter	1-9,999,999	Off Counter. Number of pulses to inhibit output during the off cycle of the Duty Cycle mode.
:ICLock	SYS / EXT10 / EXT20 / EXT25 / EXT40 / EXT50 / EXT80 / EXT100	Sets Source for the internal rate generator. System Clock or External Source ranging from 10MHz to 100MHz.
:OClock	T0 / 10 / 11 / 12 / 14 / 16 / 20 / 25 / 33 / 50 / 100	Sets external clock output. T ₀ Pulse or 50% duty cycle TTL output from 10MHz to 100MHz.
:GATE		Subsystem. Contains the commands to define the Gate function.
:MODE	DISabled / PULSe / OUTPut / CHANnel	Sets Global Gate Mode. Disable, pulse inhibit, output inhibit, channel.
:LOGic	LOW / HIGH	Sets Channel Gate logic level. Active low or active high.
:LEVel	.20V - 15V	Sets the gate threshold. Value is in volts with a range of .20 to 15 Volts.
:TRIGger		Subsystem. Contains the commands to define the Trigger function.
:MODE	DISabled / TRIGgered	Sets Trigger Mode. Disable or TRIG (enable).
:LOGic	RISing / FALLing	Selects which edge (rising or falling) to use as the trigger signal.
:LEVel	.20V - 15V	Sets the Trigger Threshold. Value is in volts, with a range of .20 to 15 Volts.

575 Channel PULSe[n] Commands (SCPI Command Summary)

Keyword	Parameter	Comments
:PULSe [1 / 2 / n]		Subsystem. Contains commands to control the output pulse generation. Valid suffix range depends on the number of channels (ChA = 1, ChB = 2, etc). Command without suffix refers to the currently selected logical instrument. See INSTRument subsystem.
:STATe	0/1 or ON/OFF	Enables/Disables the output pulse for selected channel.
:WIDTh	10ns - 999.9999999975s	Sets the width or duration of the output pulse.
:DELay	- 999.9999999975s - 999.9999999975s	Sets the time from the start of the T ₀ period to the first edge of the pulse.
:SYNC	TO, CHA, CHB, CHC, CHD, etc.	Selects the Sync source.
:MUX	0-255	Selects which timers are enabled as output for the current channel.
:POLarity	NORMal / COMPLement / INVERTed	Sets the polarity of the pulse. For NORMal operation the second nominal state is more positive than the first. COMPLement and INVERTed are aliases. For both, the second state is more negative than the first.
:OUTPut		Subsystem. Contains command to control output mode.
:MODE	TTL/ ADJUSTable/	Selects output Amplitude mode: TTL/CMOS, ADJUSTable.
:AMP	2.0V to 20V	Sets adjustable output level.
:CMODE	NORMal / SINGle / BURSt / DCYCLE	Channel Mode. Sets the channel pulse series output mode.
:BCOUNTER	1-9,999,999	Burst Counter. Sets the number of pulses to generate when channel is in the BURST mode.
:PCOUNTER	1-9,999,999	Pulse Counter. Sets the number of pulses to generate during the on cycle of the Duty Cycle Mode.
:OCOUNTER	1-9,999,999	Off Counter. Number of pulses to inhibit output during the off cycle of the Duty Cycle mode.
:WCOUNTER	0-9,999,999	Sets the number of T ₀ pulses to delay until enabling output.
:CGATE	DIS / PULS / OUTP	Sets Channel Gate Mode. Disable, pulse inhibit, output inhibit. (Global Gate Mode must be set to CHAN for this command to be available).
:CLOGic	LOW / HIGH	Sets Channel Gate Logic level. Active low or active high. (Global Gate Mode must be set to CHAN for this command to be available).

575 SYSTem Commands (SCPI Command Summary)

Keyword	Parameter	Comments
:SYSTem		
:STATe?		Query only. Returns the state of the machine: returns "1" if the machine is armed and/or generating pulses or "0" if the machine has been disarmed.
:BEEPer		Subsystem. Controls the audible beeper.
:STATe	0/1 or ON/OFF	Enables/disables the beeper.
:VOLume	0 - 100	Range is 0 to 100, Sets the volume of the beeper where 0 is off and 100 is maximum volume.
:COMMunicate		Subsystem. Controls the RS232 and GPIB interfaces.
:GPIB		Subsystem. Controls the physical configuration of the GPIB port.
:ADDRess	1-15	Sets the GPIB of the instrument.
:SERial		Subsystem. Controls the physical configuration of the RS232 port.
:BAUD	4800 / 9600 / 19200 / 38400 / 57600 / 115200 /	Sets the baud rate for both receiving and transmitting using the DB9 RS232 port.
:USB	4800 / 9600 / 19200 / 38400	Sets the baud rate for communication when using mapped comports for USB communication. Default value is 38400.
:ECHO	0/1 or ON/OFF	Enables/Disables transmission of characters received on the DB9 serial port.
:KLOCK	0/1 or ON/OFF	Locks the keypad.
:AUTorun	0/1 or ON/OFF	After power-up, unit will start generating pulses .automatically
:VERSion?		Query only. Returns SCPI version number in the form: YYYY.V ex. 1999.0
:SERN?		Query only. Returns the serial number.
:INFORmation?		Query only. Returns model, serial number, firmware version, and FPGA version numbers.
:NSID?		Query only. Returns firmware and FPGA identification numbers.
:CAPS	0/1 or ON/OFF	Forces unit to recognize commands only sent in capital letters. 1 turns on the feature - 0 disables the feature.

575 DISPlay Commands (SCPI Command Summary)

Keyword	Parameter	Comments
:DISPlay		Subsystem. Contains commands to control the display.
:MODe	0/1 or ON/OFF	Enables/Disables automatic display update. When true, front panel display is updated with serial command parameter changes. Setting to false decreases response time.
:UPDate?		Query only. Forces update of display. Use when mode is false.
:BRIGhtness	0-4	Controls intensity of display. Range is 0 to 4, where 0 is off and 4 is full intensity.
:ENABle	0/1 or ON/OFF	Enables/Disables the display and front panel lights. When Disabled the keylock is enabled to prevent parameter changes from the front panel.

IEEE 488.2 Common Commands

Keyword	Parameter	Comments
*IDN?	Identification Query	Queries the Pulse Generator Identification. The ID will be in the following format: manufacturer,model#,serial#,version#
*RCL	0-12	Restores the state of the Pulse Generator from a copy stored in local nonvolatile memory (0 through 12 are valid memory blocks).
*RST	Reset Command	Resets the Pulse Generator to the default state.
*SAV	1-12	Stores the current state of the Pulse Generator in local nonvolatile memory (1 through 12 are valid memory blocks).
*TRG	Trigger	Generates a software trigger pulse. Operation is the same as receiving an external trigger pulse.
*LBL	Setup Label	Query Form returns the label of the last saved or recalled configuration. Command Form sets the label string for the next "*SAV" command. String must be in double quotes, 14 characters max.
*ARM	Channel Trigger Reset	Resets channel triggers when channels are set to single shot or burst mode. Functions like pressing the function then run/stop button.

Appendix A - 575 Specifications

INTERNAL RATE GENERATOR

RATE (T_0 period)	0.0002 Hz to 20.000 MHz
RESOLUTION	10ns
ACCURACY	Same as timebase
JITTER	< 50 ps
SETTLING	1 period
BURST MODE	1 to 9,999,999 pulses
TIMEBASE	100 MHz, low jitter PLL
OSCILLATOR	50 MHz, 25ppm
SYSTEM OUTPUT MODES	Single pulse, burst, duty cycle, external gate/trigger
PULSE CONTROL MODES	Internal rate generator, external trigger/gate

PROGRAMMABLE TIMING GENERATOR

CHANNEL OUTPUT MODES	Single shot, burst, duty cycle, normal
CONTROL MODES	Internally triggered, externally triggered and external gate. Each channel may be independently set to any of the modes.
OUTPUT MULTIPLEXER	Timing of any/all channels may be multiplexed to any/all outputs.
WAIT FUNCTION	0 to 9,999,999 pulses
TIMEBASE	Same as internal rate generator
WIDTHS	
RANGE	10 ns-999.99999999975 s
ACCURACY	1 ns + 0.0001 x width
RESOLUTION	250 ps
DELAYS	
RANGE	0-999.99999999975 s
ACCURACY	1 ns + 0.0001 x delay
RESOLUTION	250 ps
PULSE INHIBIT DELAY	< 120 ns typical
OUTPUT INHIBIT DELAY	< 50 ns typical

SYSTEM EXTERNAL TRIGGER/GATE INPUT(S)

TRIGGER INPUT	
FUNCTION	Generate individual pulses, start a burst or continuous stream
RATE	DC to 1/ (200 ns + longest active pulse). Maximum of 5 MHz

SLOPE	Rising or Falling
GATE INPUT MODE POLARITY	Pulse inhibit or output inhibit Active high/active low

MODULE SPECIFICATIONS

TTL/ADJUSTABLE DUAL CHANNEL OUTPUT MODULE (Standard)

OUTPUT IMPEDANCE	50 ohm
------------------	--------

TTL/CMOS MODE

OUTPUT LEVEL	4.0 V typ into 1 kohm
RISE TIME	3 ns typ (10% - 90%)
SLEW RATE	> 0.5 V/ns
JITTER	50 ps RMS channel to channel

ADJUSTABLE MODE

OUTPUT LEVEL	2.0 to 20 VDC into 1 k ohm 1.0 to 10.0 VDC into 50 ohm
OUTPUT RESOLUTION	10 mV
CURRENT	200 mA typical, 400 mA (short pulses)
RISE TIME	15ns typ @ 20 V (high imp) 25ns typ @ 10 V (50 ohms) (10% - 90%)
SLEW RATE	>0.1 V/ns
OVERSHOOT	<100 mV + 10% of pulse amplitude

TRIGGER/GATE DUAL INPUT MODULE (Standard)

Standard dual channel input module, providing one trigger input and one gate input. May be used with the dual trigger firmware option to provide two independent trigger sources.

THRESHOLD	0.2 to 15 VDC
MAXIMUM INPUT VOLT.	60 V Peak
IMPEDANCE	1.2K ohm
RESOLUTION	10 mV

TRIGGER INPUT

SLOPE	Rising or Falling
JITTER	800 ps RMS
INSERTION DELAY	<160 ns
MINIMUM PULSE WIDTH	2 ns

GATE INPUT

POLARITY	Active High/Active Low
FUNCTION	Pulse Inhibit or Output Inhibit
CHANNEL BEHAVIOR	Global w/Individual Channel
PULSE INHIBIT DELAY	120 ns
OUTPUT INHIBIT DELAY	50 ns

OPTICAL OUTPUTS

WAVELENGTH	820 nm or 1300 nm
MAXIMUM SIGNAL RATE	5 MBd
MAXIMUM LINK DIST.	1.5 km
CONNECTOR TYPE	ST

OPTICAL INPUTS

WAVELENGTH	820 nm or 1300 nm
MAXIMUM SIGNAL RATE	5MBd
MAXIMUM LINK DIST.	1.5 km
CONNECTOR TYPE	ST
INSERTION DELAY	<300 ns
JITTER	<1.4 ns RMS

EXTERNAL CLOCK IN/OUT

CLOCK IN FREQUENCIES	10 MHz – 100 MHz user selectable in discrete values
THRESHOLD	2.3 V
MAX INPUT VOLTAGE	5.5 V
DUTY-CYCLE	50% (Recommended)
FREQUENCY JITTER	<10%
CLOCK OUT FREQUENCIES	To or Ref out (10 MHz – 100 Mhz) user selectable in discrete values

GENERAL

COMMUNICATIONS	USB/RS232
STORAGE	12 storage bins
DIMENSIONS	10.5" x 8.25" x 5.5"
WEIGHT	8 lbs
POWER	100 - 240 VAC 50/60 Hz <3A

FUSE

(Qty 2) 3.15A, 250 V Time-lag

OUTPUT MODULES

Standard

AT20 Dual channel, TTL/CMOS & Adjustable output module

Optional

L82 Dual channel, 820nm optical output module
L130 Dual channel, 1300nm optical output module
AT35 Dual channel, TTL/35 V high voltage output module
AT45 Dual channel, 45 V high and low impedance voltage output module (limited to 4 channels)
TZ50 Dual channel, high current TTL/CMOS (for driving 50 ohm loads) & adjustable output module
TZ35 Dual channel, high current TTL/CMOS (for driving 50 ohm loads) & 35V high voltage output module

INPUT MODULES

Standard

IA15 Dual channel, 1 trigger / 1 gate input module

Optional

IL82 Dual channel, 820nm optical input module
IL130 Dual channel, 1300nm optical input module

System Options

I Incrementing (provides automatic high speed incrementing / decrementing of delay and/or pulse width for each channel)
DT15 Dual Trigger Logic – provides additional trigger via gate input
COM Extended Communications – Adds Ethernet & GPIB
SRM Single Rackmount
DRM Dual Rackmount

*Other custom modules (LED drivers, higher voltages, current sources, and alternative input circuits) available, call with your request.

Appendix B - Safety Symbols

Safety Marking Symbols

Technical specifications including electrical ratings and weight are included within the manual. See the Table of Contents to locate the specifications and other product information. The following classifications are standard across all BNC Pulse Generator products:

- Indoor use only
- Ordinary Protection: This product is NOT protected against the harmful ingress of moisture.
- Class 1 Equipment (grounded type)
- Main supply voltage fluctuations are not to exceed +/-10% of the nominal supply voltage.
- Pollution Degree 2
- Installation (overvoltage) Category II for transient overvoltages
- Maximum Relative Humidity: <80% RH, non-condensing
- Operating temperature range of 0° C to 40° C
- Storage and transportation temperature of -40° C to 70° C
- Maximum altitude: 3000 m (9843 ft.)
- This equipment is suitable for continuous operation.

This section provides a description of the safety marking symbols that appear on the instrument. These symbols provide information about potentially dangerous situations which can result in death, injury, or damage to the instrument and other components.

Symbols Publications; Descriptions & Comments



IEC 417, No. 5031
Direct current - VDC may be used on rating labels.



IEC 417, No. 5032
Alternating current - For rating labels, the symbol is typically replaced by V and Hz as in 230V, 50Hz. DO NOT USE VAC.



IEC 417, No. 5033
Both direct and alternating current.



IEC 617-2 No. 02-02-06
Three-phase alternating current .



IEC 417, No. 5017

Earth (ground) terminal - Primarily used for functional earth terminals which are generally associated with test and measurement circuits. These terminals are not for safety earthing purposes but provide an earth reference point.



IEC 417, No. 5019

Protective conductor terminal - This symbol is specifically reserved for the protective conductor terminal and no other. It is placed at the equipment earthing point and is mandatory for all grounded equipment .



IEC 417, No. 5020

Frame or chassis terminal - Used for points other than protective conductor and functional earth terminals where there is a connection to accessible conductive terminals to advise the user of a chassis connection.



IEC 417, No. 5021

Equipotentiality - Used in applications where it is important to indicate to the operator that two or more accessible functional earth terminals or points are equipotential - More for functional rather than for safety purposes.



IEC 417, No. 5007

On (Supply) - Note that this symbol is a bar, normally applied in the vertical orientation. It is not the number 1.



IEC 417, No. 5008

Off (Supply) - Note that this symbol is a true circle. It is not the number 0 or the letter O.



IEC 417, No. 5172

Equipment protected by double insulation or reinforced insulation (equivalent to Class II if IEC 60536).



ISO 3864, No. B.3.6

Background colour - yellow; symbol and outline – black
Caution, risk of electric shock - Generally used only for voltages in excess of 1000 V. It is permissible to use it to indicate lower voltages if an explanation is provided in the manual. Colour requirements do not apply to markings on equipment if the symbol is molded or engraved to a depth or raised height of 0.5 mm, or that the symbol and outline are contrasting in colour with the background.



IEC 417, No. 5041

Background colour - yellow; symbol and outline – black
Caution, hot surface - Colour requirements do not apply to markings on equipment if the symbol is moulded or engraved to a depth or raised height of 0.5 mm, or that the symbol and outline are contrasting in colour with the background.



ISO 3864, No. B.3.1

Background colour - yellow; symbol and outline – black
Caution - (refer to accompanying documents) used to direct the user to the instruction manual where it is necessary to follow certain specified instructions where safety is involved. Colour requirements do not apply to markings on equipment if the symbol is moulded or engraved to a depth or raised height of 0.5 mm, or that the symbol and outline are contrasting in colour with the background.



IEC 417, No. 5268-a

In-position of bistable push control.



IEC 417, No. 5269-a

Out-position of bistable push control.

Appendix C - COM Option

COM Overview

The COM Option for the 575 includes a GPIB and an Ethernet interface in addition to the RS232 and USB interfaces included with the standard product. The command set is the same for the RS-232, USB, GPIB, and Ethernet. Different interfaces may be used at the same time. Responses will be made to the most recently used interface.

GPIB Interface

Also known as IEEE-488, a GPIB computer interface is optional on the 575. Before using this interface, the address must be set using the GPIB address menu item.

Ethernet Interface

The Ethernet module used is a “Digi Connect ME” module supplied by Digi Connectware, Inc. There are several ways to successfully communicate with the pulse generator over Ethernet. The two most popular methods are raw TCP/IP (such as LabView or programming with VISA libraries) and by mapping a PC COM port using the Digi Connectware’s “Realport Drivers”.

IP Address and Raw TCP/IP Connection

This document describes one of the most popular methods of setting up Ethernet communication for the Berkeley Nucleonics pulse generators. The method discussed is Raw TCP/IP communication.

The Ethernet module used in Berkeley Nucleonics pulse generators is a “Digi Connect ME” device manufactured by Digi International, Inc. It supports virtually all practical Ethernet communication methods. A set of utilities and documentation by Digi is included on the CD shipped with the pulse generator.

This discussion assumes that the Digi utilities included with your pulse generator and National Instruments VISA (version 3.3 in this procedure, see National Instruments’ website) are installed. The procedures discussed have been prepared using Windows XP service pack 2.

Determining IP Address

The Digi module has been reset to factory defaults before it left the manufacturing facility. In this mode, it is ready to be assigned an IP address by the local DHCP server. If a crossover cable is being used, the Ethernet device will assume a default IP address.

The Digi utility “Digi Device Discovery” can be used to determine the IP address that is currently assigned to the Ethernet module. Hit “Start, All Programs, Digi

Connect, Digi Device Discovery”. When the utility opens, it scans the LAN looking for Digi Ethernet modules. It may take a minute after plugging in or powering the Ethernet module before the LAN negotiates the connection with the Digi module. Hit “Refresh View” in the left column after a minute or so if the utility fails to see the unit when you start it. In some situations it is possible that the Windows Firewall will block the Digi Device Discovery from being able to see the unit. It is advisable to turn the Windows Firewall off while performing these tasks. When the utility sees the Digi device, it will display it in the list (Figure 1).

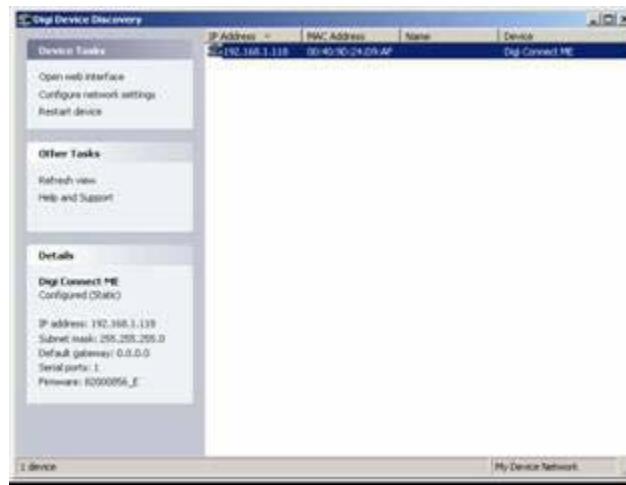

Figure 1: Digi Device Discovery utility displaying Digi module discovered on the LAN.

From this point, a web interface can be opened, allowing access to configuration options for the Digi module. If you are required to enter a username and password, they are as follows:

- Username: “root”
- Password: “dbps”

If a static IP address is desired, this change can be made from the web interface. Please note, however, that if the IP address is changed such that it is incompatible with the LAN, all communication including access to the module’s settings (including the IP address!) will no longer be possible over the LAN. If this happens, a crossover cable must be used to access the Digi module’s settings (again using Digi Device Discovery). Temporarily set the pc’s IP address to be compatible with the Digi module’s IP address to get the pc and pulse generator to ‘see’ each other over the crossover cable.

Appendix D - DT15 (Dual Trigger Option)

DT15 Overview

This module option allows the “Gate” input to function as a second trigger input. For consistency, the enabling menu for this option is located under the “Trig” menu structure. Once the dual trigger mode is enabled, both the “Gate” and “Trig” inputs can act as trigger inputs.

Adjustments for the “Gate” trigger input are located under the “Gate” menu structure. The voltage threshold level and trigger edge for the “Gate” input can be adjusted from this menu. The “Gate” trigger edge choice is only available when in dual trigger mode.

Once dual trigger functionality is enabled on the unit, each channel can be as-signed to either of the trigger inputs. The default trigger source for each channel is the “Trig” input. The trigger source selection is accessed in the secondary channel menus. To access this menu, first press the yellow “Func” button fol-lowed by the channel of interest. Continue to press “Func” then the channel button until the menu page with “Ch Gate:” and “TrigSrc:” appears. Use the “Next” button to place the cursor on the “TrigSrc” line and use the up/down arrows to change to the desired trigger source.

DT15 Menus

Trigger 1 Menu (TRIG key)

Mode: Disabled	Mode: Triggered	Mode: Dual Trig *
	Threshold Level	Threshold Level
	Trigger Edge	Trigger Edge

Enabling System Trigger

Enable the use of the TRIG input by the system timer as a trigger source.

- Mode: Selects between disabling/enabling the trigger mode(s).
- Level: Sets the trigger threshold. Edge: Selects between rising and falling edges as the trigger source when a trigger mode is enabled.

Trigger 2 Menu (GATE key) *

Mode: Disabled	Mode: Triggered	Mode: Dual Trig

	Threshold Level	Threshold Level
	Trigger Edge	Trigger Edge

*Only enabled when **TRIG** mode is set to “Dual Trig”. Functions as [Standard Gate Menu](#) when not in “Dual Trig” mode.

DT15 SCPI Command Summary

Keyword	Parameter	Comments
:PULSe [0]		Subsystem. Contains commands to control the output pulse generation. Commands without suffix refer to the currently selected logical instrument. See INSTRUMENT subsystem.
:TRIGger		Subsystem. Contains commands to define the Trigger function.
:MODE	DUAL	Sets the unit into dual trigger mode.
:PULSe[1/2/n]		Valid suffix range depends on the number of channels (ChA = 1, ChB = 2, etc).
:CTRIGger	GATE/TRIG	Sets which input is assigned to the channel trigger.

DT15 IEEE 488.2 Command Summary

Keyword	Command Name	Comments
*TTG	Trigger – Trigger Input	Generates a software trigger pulse for the TRIG input only. Operation is the same as receiving an external trigger pulse on the Trigger input.
*GTG	Trigger – Gate Input	Generates a software trigger pulse for the GATE input only. Operation is the same as receiving an external trigger pulse on the Gate input.

Appendix E - AT35 (35V Output Option)

AT35 Description

When the Adjustable Mode is enabled for this module, the outputs will provide an adjustable output from 5 volts to 35 volts. The pulse width can be set over the standard range of the unit, but the 35 volt output will self limit to approximately 4 μ s with some droop. There is no change to TTL output mode functionality with this module.

To maintain the highest possible rise time, care must be taken with cabling and termination. Low capacitance cable and 50 ohm termination will provide the fastest rise times without overshoot. Faster rise times can be achieved by increasing the termination resistance, but some overshoot is likely to occur. While the 35 volt output provides a fast, controlled rising edge, the pulse width and falling edge are not tightly controlled. Also, when using the 35V mode, the option will only function if the 'Polarity' is set for "Active High".

AT35 Specifications

Through a 50 ohm load at 200 Hz

Output	5 V – 35 V
Setpoint Resolution	10 mV
Rise Time	< 30 ns
Accuracy	500 mV
Max. Frequency (Internal & External)	4000 Hz

Appendix F - TZ50 (Impedance Matching Output Module)

TZ50 Overview

This module option allows a user to have a 50 Ohm load on the output while maintaining output amplitude of at least 4 Volts while in the TTL/CMOS mode. All other functionality of the module is the same as the AT20 modules, including output while using the Adjustable Mode Function of the channels.

TZ50 Specifications

TTL/CMOS Mode

Output Level	4.0 V typ into 50 Ohms
Rise Time	3 ns
Slew Rate	0.5 V/ns
Jitter - Channel to Channel	50 ps RMS

Adjustable Mode

Output Resolution	10 mV
Current	100 mA typ, 400 mA max (short pulses)
Slew Rate	0.1 V/ns

*Note: The TZ50 module has significant overshoot and ringing through high impedance (see figure below).

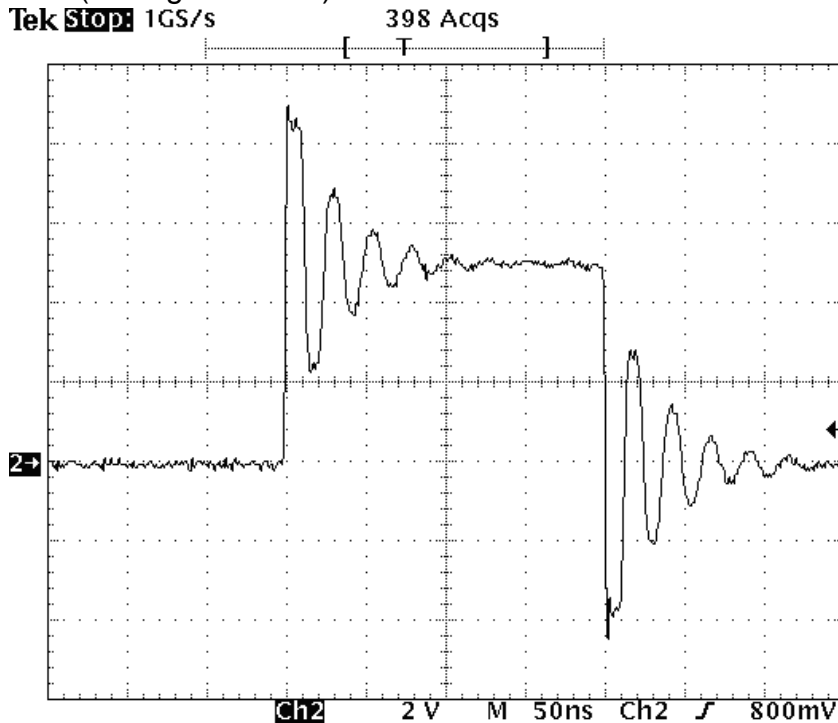

Appendix G - Increment Modes Option

Increment Overview

The System Increment modes are a pair of special modes, which allow the delay and width of each channel to be incremented at the end of a burst of pulses. Each channel is independent and each may be set with different initial values and different values for the step size for both the delay and the pulse width.

There are two incrementing modes, Increment and DC Increment. In the Increment mode, each start command or external trigger produces a burst of pulses. At the end of the burst the appropriate delays and pulse widths are incremented and the instrument is armed for the next start command. In the DC Increment (Duty Cycle) mode the output is starting as with the normal duty cycle mode. At the end of each cycle the delays and pulse widths are incremented. This continues for the number of cycles defined by the Cycles parameter. The modes are selected from the system mode menu. The step sizes are specified in the channel menus.

Increment Menus

System Mode Menu 1 Extensions (FUNC + MODE key)

MODE: BurstIncr	MODE: DCIncrement
	#/On
#/Burst	#/Off

System Mode Menu 2 Extensions (FUNC + MODE key)

MODE: BurstIncr	MODE: DCIncrement
	Cycles
T ₀ Period	T ₀ Period

Setting System Increment Modes of Operation

The **MODE** menu sets the T₀ system timer mode. The menu will show the extra set parameters (Burst, On & Off) only when they are appropriate.

- Mode: Selects the T₀ mode: Continuous, Single Shot, Burst or Duty Cycle mode.
- Burst: Sets the number of pulses to be generated when in Burst mode.
- On: Sets the number of pulses to be generated during each on cycle.

Off: Sets the number of pulses to skip each during off cycle when in the Duty Cycle mode.

Cycles: Sets the number of DC Increment Cycles to generate before completion.

To: Sets the T_0 period which determines the fundamental output frequency of the unit.

Advanced Channel Menu Increment Extension (FUNC + channel key)

Channel Enable
Increment Wid *
Increment Dly *

Setting the Channel Increment Parameters

To define a pulse requires two parameters: the delay to the active edge and the width of the pulse.

IncW: Sets the channel pulse width.

IncD: Sets the channel delay until the active edge.

Increment SCPI Command Summary

Keyword	Parameter	Comments
:PULSe[0]		Subsystem. Contains commands to control the output pulse generation. Commands without suffix refer to the currently selected logical instrument. See INSTRUMENT subsystem.
:MODE	BINCRement /	Sets the T_0 mode. Added parameters for Burst Increment and Duty Cycle Increment mode.
:CYCLE	<numeric value>	Sets the number of cycles to generate in Duty Cycle Increment mode.
:IRESet	1	Resets the width and delay increment parameters on all channels.
:PULSe[1/2/n]		Subsystem. Contains commands to control the output pulse generation. Valid suffix range depends on the number of channels (ChA-1, ChB-2, etc . . .). Command without suffix refers to the currently selected logical instrument. See INSTRUMENT's subsystem.
:IWIDTH	<numeric value>	Sets the pulse width increment step size.
:IDELay	<numeric value>	Sets the delay increment step size.

Increment Initialization and Reset (FUNC + CLR)

Pressing the **FUNC** key then **CLR** initializes the increment parameters and resets the delays and pulse widths to their initial conditions. This must be done after setting all the step parameters, but before generating any pulses.

Increment Specifications

Width Step Size -1.00 s to 1.00 s

Width Minimum Step 10 ns (-10 ns)

Width Step Resolution	250 ps
Width Incremented Range	10,000 s
Delay Step Size	-100 ms to 100 ms
Delay Minimum Step	10 ns (-10 ns)
Delay Step Resolution	250 ps
Delay Incremented Range	10,000 s

**Note: Any increment value between -10ns and 10ns will disable the increment function for that parameter.*

Update Rate	10 μ s + 30 μ s per active channel (1 Ch @ 25 kHz to 8 Ch @ 4 kHz)
-------------	--

Appendix H - AT45 Option (45 Volt Output)

AT45 Option Overview

For channels with AT45 output option, the maximum frequency is limited to 100 kHz. The pulse width can be set over the standard range of the unit with both active high and low outputs when set to high impedance mode. In low impedance mode, the pulse width is limited to a maximum of 10s and the active high output is no longer allowed. To maintain the highest possible rise time, care must be taken with cabling and termination. Low capacitance cable and 50 ohm termination will provide the fastest rise times without overshoot. The channel menu structure for the AT45 module changes are described in the table below (changes from standard outputs are in bold italics).

AT45 Protection Error Messages

When an AT45 module is present, the system performs self-checks to insure the module is not damaged when attempting to over-drive.

Module Errors

If a channel on any AT45 module is over-driven, the channel will disable itself and the system will indicate an error on the module. The error will not clear until the user presses **FUNC - PERIOD** key sequence to clear the error, or power cycles the instrument.

System Limit Error

The system will not allow the Lo Impedance enabled AT45 channels to exceed 150V total amplitude. If this situation occurs, the "Over-Driving Unit" error is displayed and the currently adjusting amplitude is reduced to the 150V enabled system limit.

Voltage Change Timing

The channels adjustable voltage changes very quickly when adjusting from a lower voltage to a higher voltage but changes slowly when changing from a higher voltage to a lower voltage. It takes approximately 30s to change from 45V to 3.0V so caution must be taken when adjusting the voltage to a lower voltage tolerant circuit.

AT45 Channel Menus

Channel Output Configuration Menu

Channel Enable	Channel Enable
Output Type: High Z	Output Type: Low Z
Polarity	
Output Level	Output Level

AT45 SCPI Command Extension Summary

Keyword	Parameter	Comments
:PULSe [1 / 2 / n]		Subsystem. Contains commands to control the output pulse generation. Valid suffix range depends on the number of channels (ChA = 1, ChB = 2, etc). Command without suffix refers to the currently selected logical instrument. See INSTRument subsystem.
:OUTPut		Subsystem. Contains command to control output mode.
:MODE	HIZ / LOZ	Selects output Amplitude mode: High Impedance or Low Impedance
:AMP	4 V – 45 V	Sets adjustable output level.
:MERRor	1	Command clears the last module error to allow the unit to generate pulses again. Query returns the last displayed error.

AT45 Specifications

Amplitude	4 V – 45 V
Resolution	20 mV
Accuracy	+/-1.5%
Rise Time	< 2 ns Typical 10%-90% (Low Z) < 9 ns Typical 10%-90% (High Z)
Fall Time	< 9 ns Typical 90%-10% (Low Z) < 7 ns Typical 90%-10% (High Z)
Frequency (Internal & External)	DC – 100 kHz
Overshoot	<35% Typical Allowed for Fast Rise Time
Polarity - High Z (>10k)	Active High or Active Low
Polarity - Low Z (50 Ohms)	Active High Only
Pulse Width - High Z (>10k)	10 ns to DC
Pulse Width - Low Z (50 Ohms)	10 ns to 10 s
Current (maximum)	35 mA (High Z @ 10 ms width) 900 mA (Low Z @ 10 ms width)

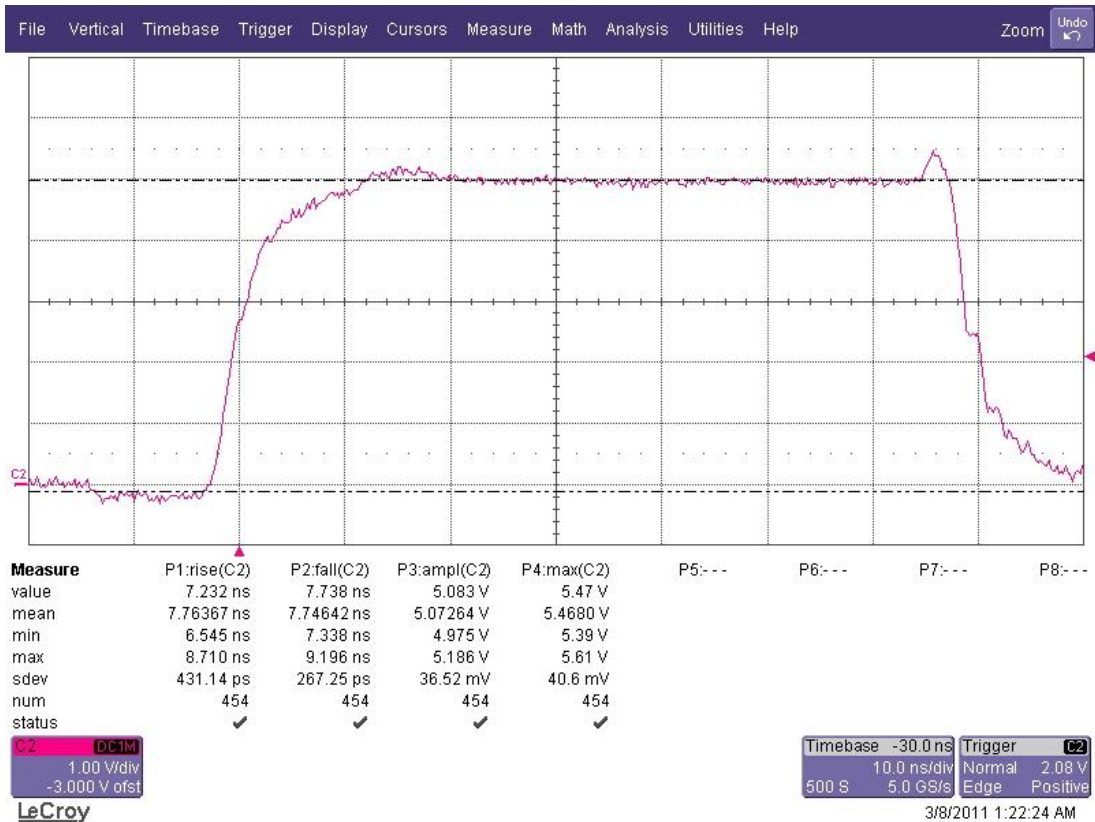

Figure 1 (High Z 5V)

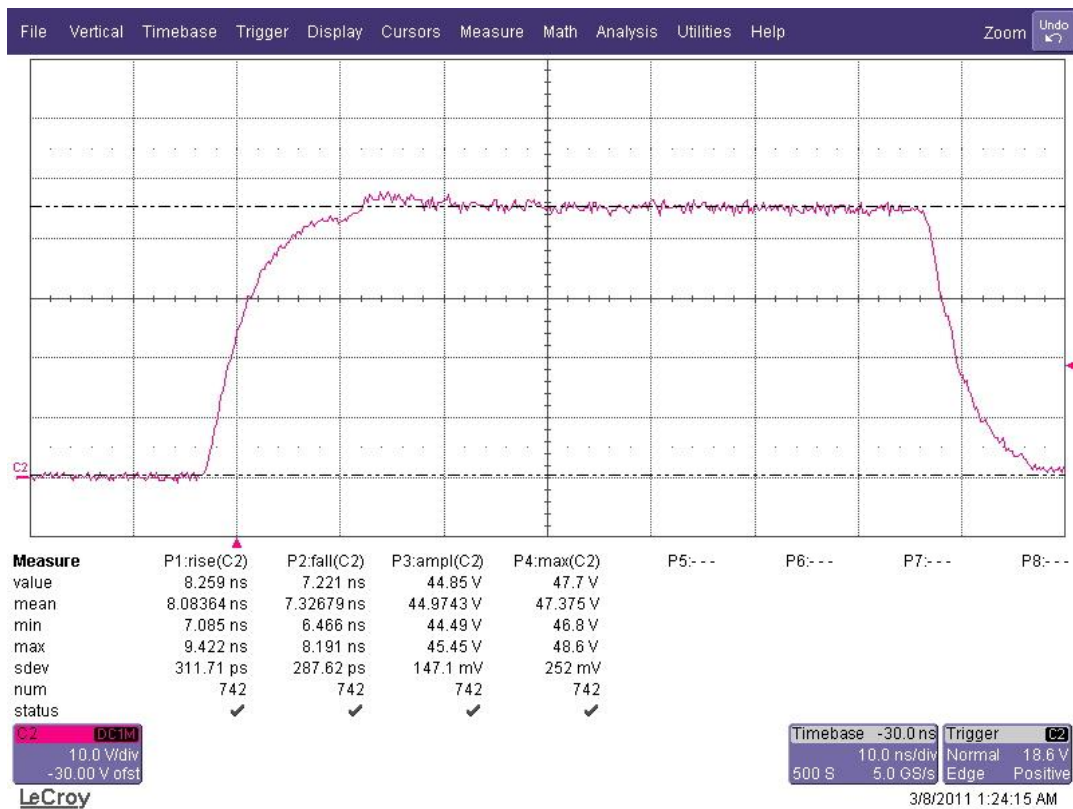

Figure 2 (High Z 45V)

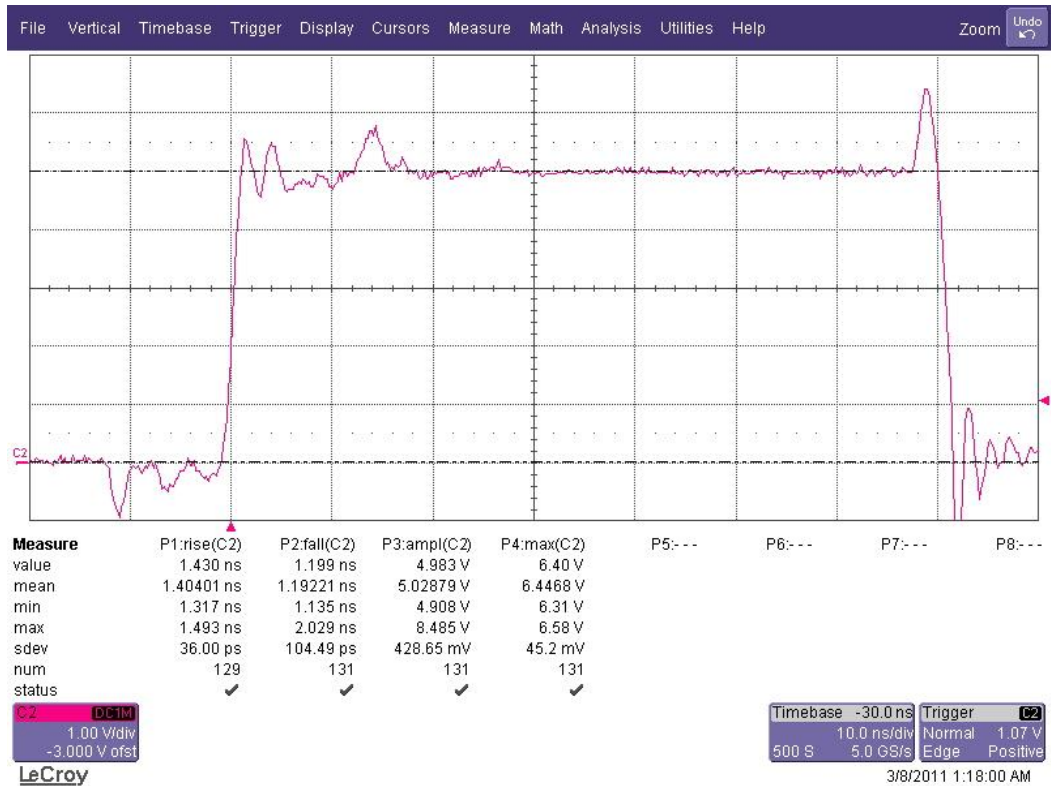

Figure 3 (Low Z 5V)

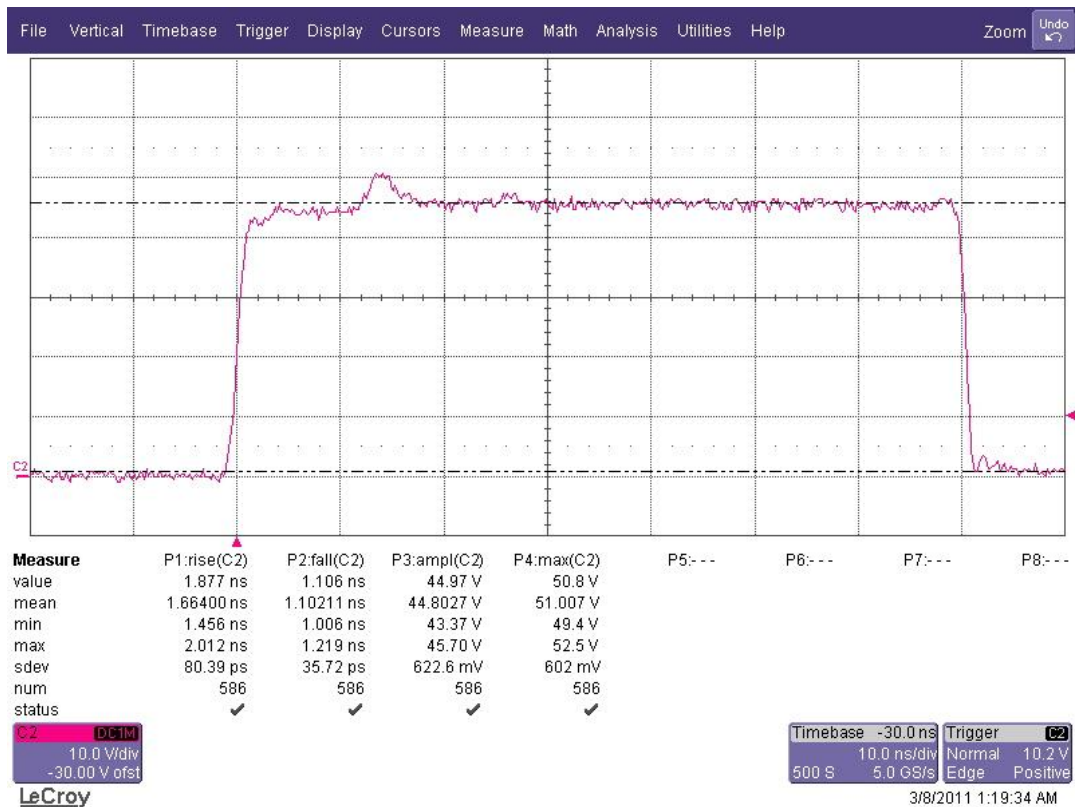

Figure 4 (Low Z 45V)

Rise time and overshoot are tuned for best response at low impedance (low Z)

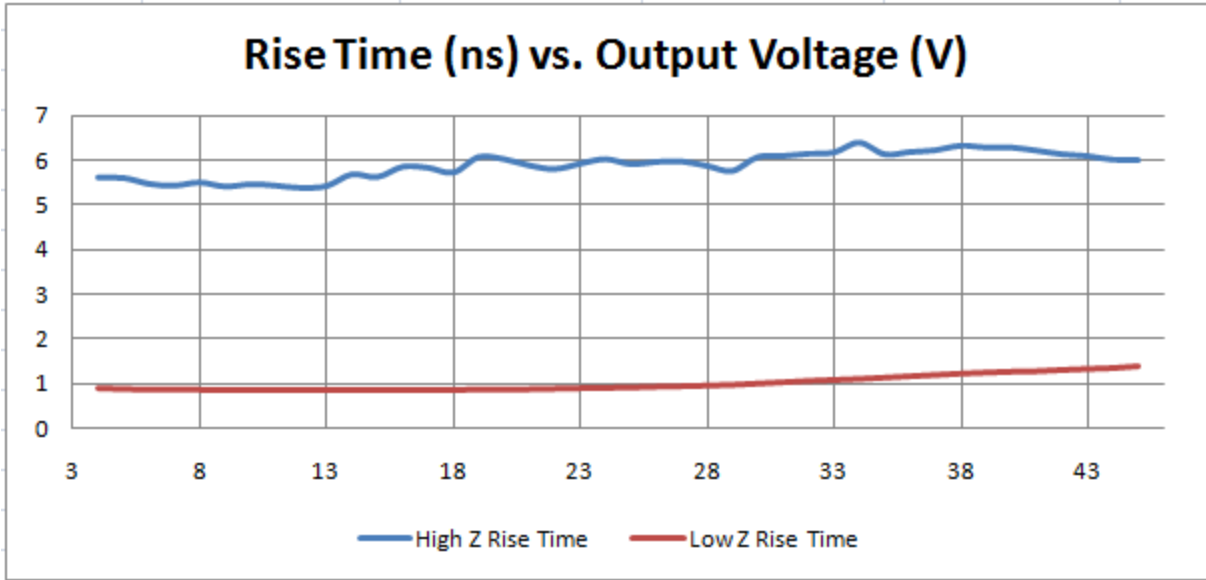

Figure 5 (Rise Time versus Output Voltage)

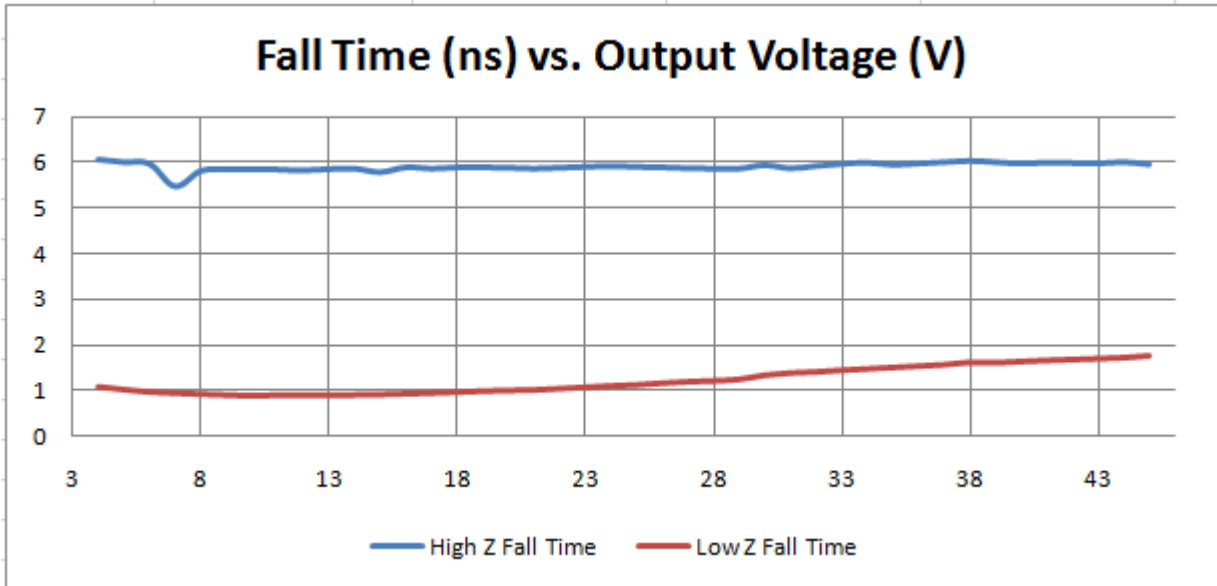

Figure 6 (Fall Time versus Output Voltage)

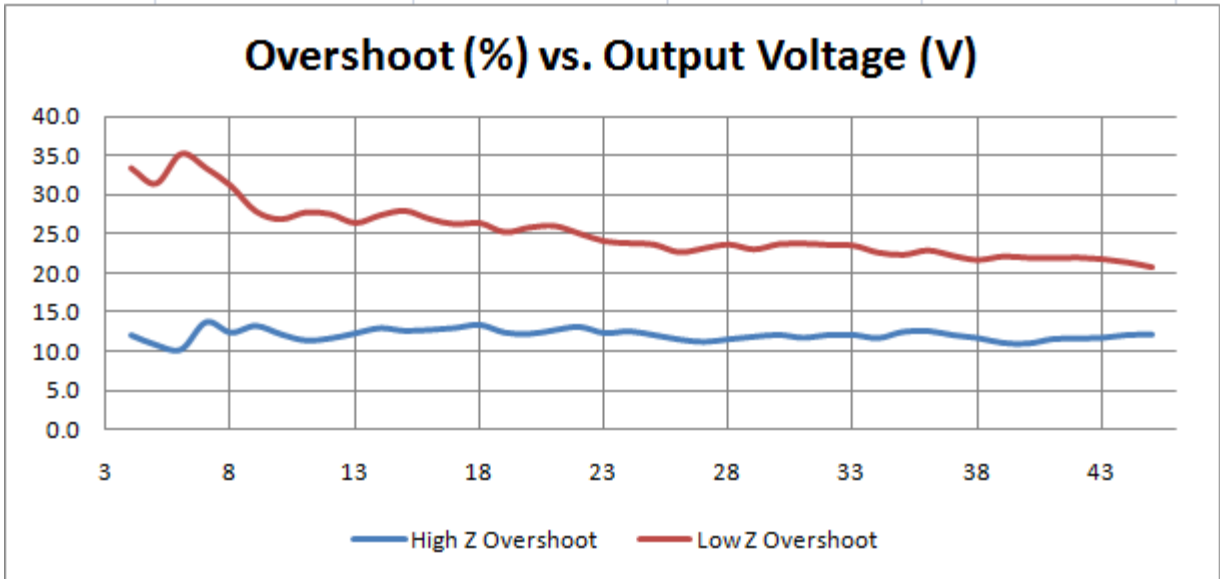

Figure 7 (Overshoot Versus Output Voltage)