

Introduction

We welcome ideas and criticisms of the manual. If you see an error or unclear writing, let your TA know, so that future students can benefit from an improved experience.

The Staff of Physics 109

Table of Contents

Table of Contents	2
Lab 1: Reflection and Refraction	6
Law of Reflection	6
Experiments	6
1. Angle of Reflection	6
2. How Large Does a Mirror Need to Be?	7
3. Location of Mirror Image	8
4. Corner Reflectors.....	8
5. Polarization by Reflection.....	8
Law of Refraction (Snell's Law)	8
Experiments	9
1. Index of Refraction.....	9
2. Reversibility	10
3. The Critical Angle.....	10
4. Total Internal Reflection.....	11
5. Dispersion	11
6. Light Passing through a Window Pane or Prism.....	11
Lab 2: Lenses	12
Equipment	13
Experiments	14
1. Focal Length.....	14
2. Magnification	14
3. Lens Formula.....	15
4. Depth of Field	16
5. Chromatic Aberration	16
6. Compound Lenses	17
Lab 3: Photography	18
Digital cameras vs. film cameras	18
Experiments	19
1. Setting up the Camera.....	19
2. Pixels	20
3. Focus	23
4. Exposure time	24
5. Aperture.....	25
6. ISO	26
7. Exposure vs. Aperture—Reciprocity.....	26
8. Exposure vs. Aperture—depth of field.....	27
9. Have fun!.....	28
Lab 4: Additive Color Mixing	29
Introduction	29
Equipment	30
Experiments	30
1. Hue, Saturation, and Brightness.....	30
2. White.....	30

3. Color Triangle or Chromaticity Diagram	30
4. Locating R, G, B on the Color Triangle.	31
5. Adding Two Primaries: Blue and Green.....	32
6. Red Added to Green; Red Added to Blue	32
7. Complementary Hues	32
8. Color Matching.....	33
9. Matching Pigments.....	33
Lab 5: Subtractive Color Mixing.....	34
Equipment	34
Experiments	35
Setting up the spectrophotometer:.....	35
1. Experiments With Filters:.....	36
2. Mixing Paint	37
3. Mixing pigments in acrylic paints: unequal parts of Y and M.....	38
4. Mixing unequal parts of M and C.....	38
Lab 6: Oscillators and Resonance.....	39
Oscillators	39
1. Spring Constant	39
Natural Frequency	40
Damped Oscillations	42
1. Observation of damping (without using computer).....	42
2. Careful measurement of damping time	43
Resonance	44
Resonance Curve	44
Buildup Time of Oscillation.....	46
Lab 7: Strings.....	47
Standing waves	47
Slinky Experiments.....	48
1. Frequencies of Modes	48
2. Pulse on Slinky.....	48
Experiments with String	49
1. Computer As Driver Control	50
2. Finding the Fundamental Mode	50
3. Higher Modes	50
4. The “Plucking Game”	51
5. Changing the Length of The String.....	51
6. Changing the Tension on the String.....	52
7. Changing the Mass Per Unit Length of the String	52
Lab 8: Pipes.....	53
Equipment	53
Experiments	54
1. Modes of the Pipe.....	54
2. Effect of Length and Diameter of the Pipe	54
3. Closed Pipes	55
4. Pipes with a Fingerhole.....	56
5. Rise and Decay of Pipe Oscillations	56
Lab 9: Musical Scales	57

Equipment	57
The Just Scale	58
1. Tuning Triads	58
2. Sensitivity to Tuning	58
3. The Black Keys of the Keyboard.....	59
4. The Missing Black Keys	59
5. Problems With the Just Scale	59
The Tempered Scale	59
Transposition	60
1. Major Scale.....	60
2. Minor Scale	61
Lab 10: Fourier Analysis and Musical Instruments	62
Fourier Synthesis	62
1. Two Sine Waves of the Same Frequency	62
2. Building a Square Wave from Sine Waves	64
3. Does One Hear Phase?	64
Fourier Analysis.....	65
1. Fourier Analysis of Sine Waves	65
2. Fourier Spectrum of the Square Wave	65
3. Fourier Analysis of Musical Instruments and the Voice: Introduction	65
1. The Voice	66
A. Source of Sound.....	66
B. Formant	67
C. Same Vowel — Different Pitch.....	67
D. Different Vowel — Same Pitch	67
2. Guitar	67
A. Why Frets?.....	68
B. Placement of Frets	68
C. Semitone Intervals on Guitar	68
3. Timbre of Bowed String — Violin.....	68
4. Piano Hammers	69
5. Wind Instruments I	70
A. Excitation Mechanism	72
B. Length of Pipe	72
6. Wind Instruments II.....	72
A. Natural Scale.....	72
B. Changing the Length of the Pipe with Valves	73
7. Tympani (Kettle Drum)	74
Appendix: Using the Oscilloscope	76

This page intentionally left blank.

Lab 1: Reflection and Refraction

Part 1: Reflection

To understand how images are formed when light is reflected from surfaces (mirrors), we need to know how the direction of light rays is changed by shiny surfaces, such as mirrors.

Law of Reflection

We want to find out in which direction a beam of reflected light comes off the reflecting surface. Figure 1 shows how we measure the direction of a light ray. The **incident beam** of light comes from one point of the object: if you look at yourself in a mirror, your face should be considered the object, and a particular point is the tip of your nose. You don't have to be right in front of the mirror for it to form an image of your face.

The **normal** is a line perpendicular to the mirror. We draw it at the point where the incident ray hits the mirror.

The **angle of incidence** is the angle between the **incident beam** and the **normal**. In the drawing, the angle of incidence is labeled i .

The **angle of reflection** is the angle between the **reflected beam** and the **normal**. In the drawing, the angle of reflection is labeled r .

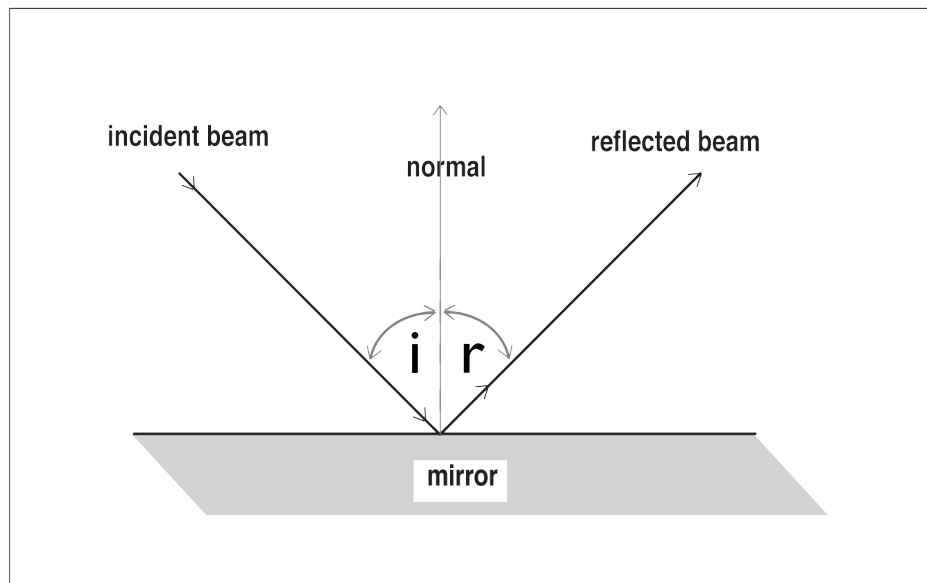

Figure 1

Experiments

1. Angle of Reflection

A small mirror is mounted on a platform labeled "Ray Table" that can be rotated. The Ray Table has angle markings that you can use to measure the angle of incidence and the angle of reflection for a beam of light.

The light beam is produced by placing a narrow slit in front of a light source.

- Move the light source so that the light beam coincides with the diameter line marked “normal” on the Ray Table (see Fig. 2).
- Place the mirror along the other diameter, marked “component,” so that the mirror is perpendicular to the incident light beam — this is referred to as “normal incidence.”
- Rotate the Ray Table so the incident ray is at 20° from the normal. Measure i and r .
- Vary i in regular steps, and at each step, measure r . In your notebook prepare a table to show how r changes when i is varied. Use a wide range of angles i , like this:

i	r
20°	?
⋮	⋮
70°	?

- State your conclusion.

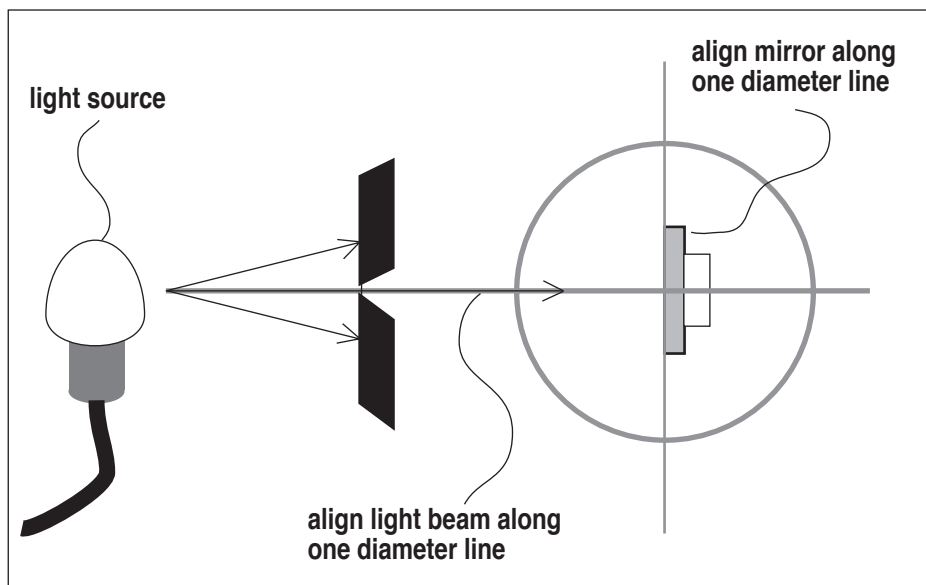

Figure 2

2. How Large Does a Mirror Need to Be?

- What is the smallest size mirror that allows you to see all of yourself head to toe? What size if you want to see your face — chin to top of head? Make a guess at the answer in your notebook.
- Now do an experiment to find out! Have your lab partner mark off the top and the bottom part of the mirror until the mirror is just the right size. Measure the height of the amount of mirror that you need, and compare to your height.
- Try to understand the answer in terms of the law of reflection.

3. Location of Mirror Image

- Look at the image of a marker in the semi-transparent mirror. Have your lab partner hold a second marker behind the mirror until it seems to be in the same place as the image of the first. Where is the image compared to the object?
- Move around and see if the image position changes when you move to different distances from the mirror.

4. Corner Reflectors

Astronauts have placed mirrors on the moon to reflect a laser beam from earth. If the angle of the mirror is ever so slightly off, the reflected light beam will miss the observer on earth. One solves this problem by using a "corner reflector."

- Look at the corner reflector in the lab. Change the angle between the mirrors. Can you figure out what the angle should be for the reflected beam to come back exactly parallel to the incident beam no matter how the beam is angled?

5. Polarization by Reflection

Light reflected from a glass plate or a shiny surface (the lake, a car hood, a linoleum floor) is polarized, which means that the electrical oscillations are primarily in one direction. Polaroid glasses cut out glare because they pass light only for certain directions of polarization.

- Go out into the hallway and look through a polaroid filter at the reflections of the ceiling lamps in the linoleum floor tiles. Slowly rotate the polaroid clockwise or counterclockwise for a full turn, and notice that for some orientations, the glare is much reduced.
- The polarization of the reflected light depends on the angle of reflection: there is one particular angle when a light is completely polarized. Try it! You should be able to find one lamp whose reflection disappears completely when you orient the polarizer the right way.

Part 2: Refraction

To understand how images are formed when light traverses a curved piece of transparent material (a lens), we need to know how the direction of light rays is changed by the transparent material.

Law of Refraction (Snell's Law)

When a light beam hits the surface of a transparent object, such as acrylic, glass, clean water or clear plastic, the light beam splits into two components. Part of the light is reflected, following the law of reflection you just studied, and another part of the light passes through the acrylic. One calls the light beam that passes through the acrylic the "refracted" ray, as opposed to the "reflected" ray that bounces back from the surface.

The light ray makes a kink when it passes through the surface. The angle of refraction is the angle the light ray inside the acrylic makes with the normal to the surface. We call this angle θ_2 . The angle of incidence is measured as we did above as the angle between the incoming light ray and the normal to the acrylic. We labeled it θ_1 .

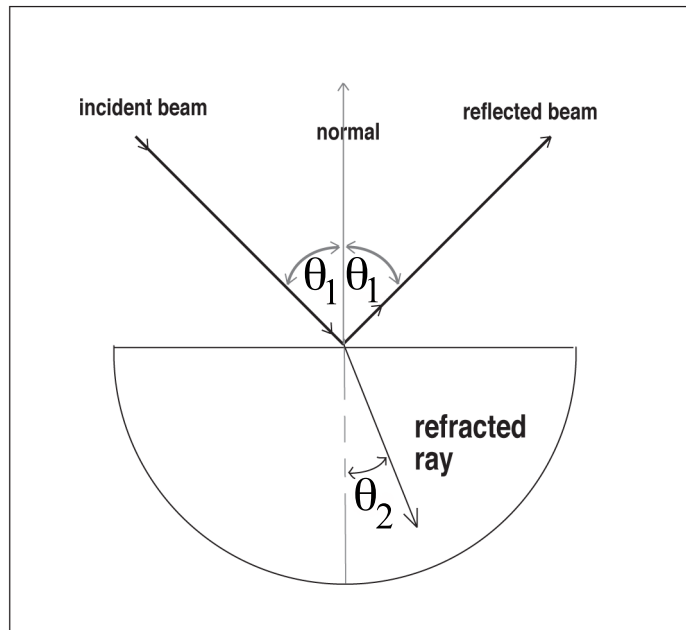

Figure 1

Experiments

1. Index of Refraction

- Place the half circle of transparent acrylic on the half-circle shape drawn on the Ray Table. Turn the Ray Table such that the light beam enters the acrylic in the center of the semicircle, as in Fig. 1.
- Make sure you are able to see the refracted ray of light clearly through the acrylic when viewed from the top.
- Turn the Ray Table to different positions, and each time, use the scale inscribed on the circumference of the Ray Table to measure the angle of incidence θ_1 and the angle of refraction θ_2 . Present the results as a table in your notebook. Provide space for five columns in your table.
- Use a calculator to calculate $\sin \theta_1$ and $\sin \theta_2$, and fill in the values in the table in your notebook.
- Finally, calculate $\sin \theta_1 / \sin \theta_2$ and enter the results in the last column.

The number you calculated in the last column of the table is called the ***index of refraction***. In your table of results, please note that there is no simple relationship between θ_1 and θ_2 , but there is a simple relationship between $\sin \theta_1$ and $\sin \theta_2$. This relation between the sines of the angles is called Snell's law.

$$\text{Snell's Law: } n_1 \sin \theta_1 = n_2 \sin \theta_2$$

Note that n is 1 for vacuum and air, and larger than 1 for all other materials, thus when light

goes from a less dense to a denser material the angle of refraction is smaller than the angle of incidence, thus the ray is kinked **toward the normal**.

The beauty of Snell's law is that once you know the indices of refraction of both materials, you can immediately predict the direction of the refracted light ray inside the second material, for example, in plastics such as acrylic, glass, or water, and for any for any angle of incidence θ_1 . Without knowing this relationship, it would not be possible to design, for instance, camera lenses — one needs to be able to predict how much a curved piece of glass kinks the light ray if one wants to figure out how to make a lens.

2. Reversibility

Snell's law applies to either direction of the light path — light coming in from air or light going out into air.

- Reverse the light path by turning the Ray Table half-way (i.e. 180°) around.
- Refer back to the table you made in Experiment 1, keeping in mind that now you start from acrylic and go into air, so the angle of incidence θ_1 is in acrylic, and the angle of refraction θ_2 is in air. Make the angle of incidence θ_1 the same as for one of your earlier θ_2 in the table — is the angle of refraction θ_2 the same as it was (θ_1) for the opposite direction of the light path?

If all went well, you found that the path of light is exactly the same for light traveling in either direction — if you took a photograph of the light path, you would not be able to tell whether the light traveled from air into the acrylic or from the acrylic into the air.

3. The Critical Angle

You may have figured out already why we are using a semi-circle of acrylic with the light traveling along a *radius* of the semi-circle: this way the light ray is perpendicular to the curved surface and therefore does not kink, which makes measuring the angles easier.

- Look at the light beam going through the semi-circle of acrylic and hitting the inside straight face: note that there is a reflected beam and a refracted beam.
- Turn the Ray Table and observe the intensity of the reflected beam as you change θ_1 . At a certain point, the refracted beam disappears and the reflected beam gets correspondingly brighter. The angle θ_1 at this particular point is called the "critical angle".

The term "critical angle" refers to the point where the refracted ray *just* disappeared — make θ_1 a little smaller and the refracted ray comes back. "Internal reflection" refers to the fact that the reflection is taking place on the *inner* surface of the acrylic.

- Measure the critical angle with your setup. Note that at the critical angle the refracted ray made an angle $\theta_2 = 90^\circ$ to the normal.
- Calculate the critical angle from Snell's law by setting $\theta_2 = 90^\circ$ and compare to the observed critical angle.

4. Total Internal Reflection

- Turn the Ray Table further while you observe the reflected ray inside the acrylic. What do you observe? When you go beyond the critical angle all the light is reflected, since none of the light can go out into refraction. This condition is referred to as total internal reflection. It happens for all angles θ_1 larger than the critical angle.

Above we talked about the critical angle — the complete expression for this angle is “critical angle of total internal reflection,” meaning that beyond this angle all the light is reflected, none is refracted.

5. Dispersion

- Rotate the Ray Table so that the angle of refraction θ_2 is almost 90° . The refracted beam shows the colors of the rainbow. It may help to hold a piece of paper in the path of the refracted beam to see the colors.

What we call “white light” is really made up of all colors of the rainbow, and each color has a slightly different index of refraction, i.e. a different kink angle. The colors spread out more as the angles get larger.

- Look at the sequence of colors: is blue light kinked more or less than red light? Does this mean that the index of refraction is larger or smaller for blue light?
- When we say that a material shows “dispersion,” we mean that different colors have a different index of refraction.

6. Light Passing through a Window Pane or Prism

- Use the block of clear acrylic (Figure 2) from the ray optics kit box to study what happens to light rays when they go through a sheet of acrylic or glass, such as a window pane.
- In your notebook, make a large drawing of a piece of acrylic with parallel faces, and a light ray entering the acrylic at a large angle. Draw the ray inside the acrylic and the ray coming out the other side. Use the law of refraction to relate the angles and write them in the drawing.
- Do the same for a prism (triangle of acrylic).
- Again place them such that you can clearly see the ray inside when viewed from the top.

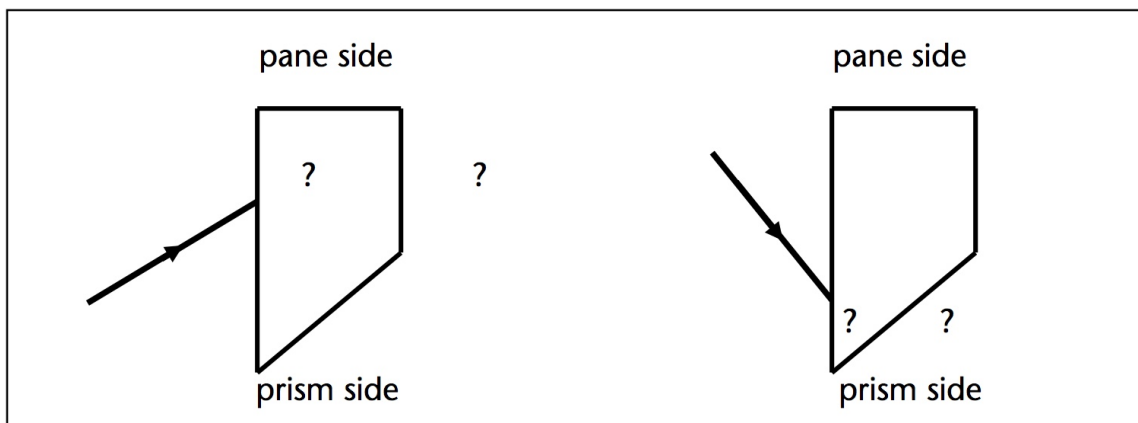

Figure 2

Lab 2: Lenses

You should review the lecture notes about lenses and study this lab manual before you come to the lab, otherwise you may find it difficult to follow the ideas behind the lab experiments below.

Figure 1 shows how light rays that originate from one point of an **object** (in this case, the top of the head) are kinked by the lens to converge at another point, forming a real **image** of the object. Note that each part of the lens must kink the light ray by a different amount: the ray hitting point A near the top of the lens must be kinked down, the ray hitting point B of the lens must be kinked up, the ray through the center of the lens is not deflected. The rays that pass through the lens half-way up or down the lens, as at point B, must be deflected less than those through A. Thus, the kinking angle for point B on the lens is smaller than for point A, because point B is closer to the center of the lens.

It is important to understand that the light rays are kinked by the **same** angle if they enter the lens at the **same** point, no matter where the rays come from. The kinking angle at point A is the same for rays coming from the top of the head or the bottom of the skirt. The two shaded triangles left and right of each lens in Fig. 1 have exactly the same kink angle at point A.

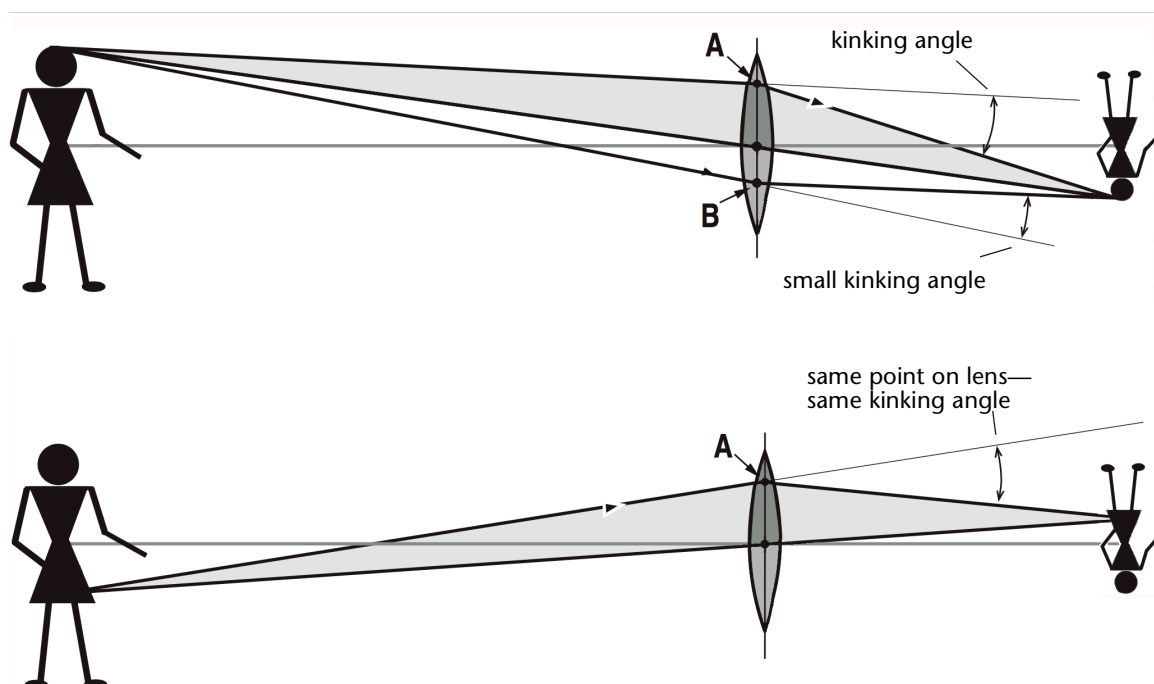

Figure 1

Similarly, **any** ray passing through the center of the lens is undeflected, no matter where it came from.

In Fig. 1 you notice another interesting point: if you were to cut off or cover up the entire bottom half of the lens, you would **still** get a **complete** image of the person, because all the rays within the shaded triangles would still converge to the same point. Using the complete lens, the image

is **brighter** because the rays through the bottom half of the lens add light intensity to the image. Not only can you remove the bottom half of the lens and still get an image, you can remove most of the top half as well.

In a drawing such as Fig. 1, where a person is in front of a lens, we do not really mean that the lens is as big as the person! We only show a huge lens so that we can use the “easy rays” to construct the image. In reality, the lens is much smaller, but the image for a smaller or larger lens is formed in exactly the same place because **all** rays from an object point going through the lens converge to the same image point. This is strictly true only for an ideal lens, without “aberrations.”

Why don't they make perfect lenses? Well, suppose the lens is shaped to produce a perfect image of the tip of your nose when you are 2 meters away from the lens: **all** rays from the nose converge to one point on the film or the screen. But now the same lens will **not** be perfect for rays that come from another part of the object, such as your toes. The art of making good lenses is to make a compromise, such that one gets a sharp image for different directions of the incident rays and for a wide range of different object distances.

The lenses you use in the lab are ground to simple spherical shape. One part of today's experiment is to study the problem of lens aberrations. A lens has **aberrations** if the rays coming from one point of the object do not converge to one **point** of the image. The effect of lens aberrations is that the image is distorted or out of focus in some way: for instance, a small dot on the object (·) may appear as a short line (|) on the screen.

Above, we mentioned that each part of the lens kinks the light ray incident on that part of the lens by a certain angle, independent of the direction of the incident light ray. This idea is very useful to relate object distance and image distance to one another without need for any calculation. In Fig. 2, we show the kinking angle at point A of the lens for a ray coming from the bottom of the candle. Imagine now that the candle is moved away from the lens. Keep the same kinking angle at point A to see in which direction the image of the candle moves: Is the new image farther or closer to the lens?

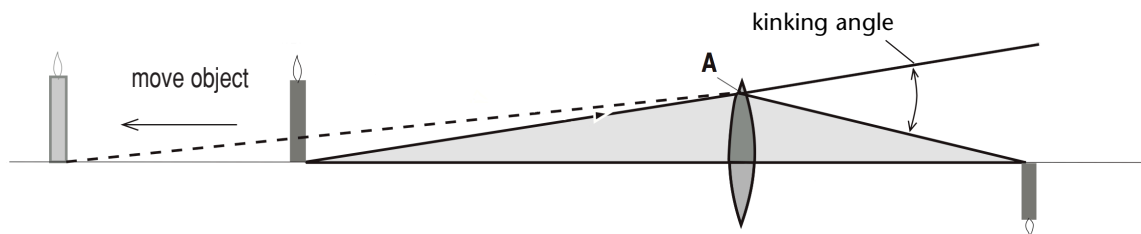

Figure 2

Equipment

An **optical bench** is a long steel track with stands to hold a light source, a screen and a lens. The bench has a centimeter ruler along one side to measure the distance between different components, such as the object distance and the image distance. Using a transparent plastic ruler as the object is useful to accurately measure the magnification, plus the sharp straight lines on the ruler make it easy to check for accurate focus. In addition, you are provided with discs with

holes of different diameters to cover up part of the lens, which is equivalent to using an *aperture*, as used by camera lenses, or during lecture demos. We use these discs to study the effect of changing the lens aperture on the quality of the image. In a camera, changing the aperture changes the diameter of the lens that is used to take a photo.

After we measure the *focal length* of the lenses, we will analyze images formed by lenses: Where is the image? How big is the image with respect to the object? How does one use the lens formula? What does *depth of field* in photography mean?

Experiments

1. Focal Length

A *converging lens* kinks parallel light rays so that they converge toward a point on the other side of the lens. The distance from the center of the lens to the point where the rays converge is called the *focal length* of the lens, and it is an intrinsic property of the lens, that is, it is built into the lens by the manufacturer, and you cannot change it. The focal length is usually measured in millimeters (mm) and is represented by the letter f . For a simple film camera the lens is typically a “50 mm-lens”, the focal length is 50 mm or about 2 inches.

- Measure the focal length of lens #1 by producing an image of an object **at infinity**, that is, an object more than 5 m away from the lens, for example a tree or a building outside the window. At night, you can use a light bulb placed at the other side of the room. When the object is at infinity, the incident rays are parallel. After passing through the lens, the rays converge, forming an image at a distance of one focal length f away from the lens. To see the image, use a piece of paper as a screen. Measure the distance from the lens to the image with a ruler.
- Make a ray diagram in your notebook showing a converging lens, the parallel rays from the object to the lens, and the converging rays after the lens. Mark f in your drawing.
- How must one change the shape of the lens to obtain a shorter focal length? Remember that a shorter focal length lens kinks the rays more — is lens be more curved or less?
- Find a lens of this shape--call this lens S--and measure the focal length the same way you did above. Record the focal length f for both lenses in your notebook.

2. Magnification

When you project a slide or a movie with a projector, or when you take a photograph of an object, it may be useful to understand the relationship between the size of the image compared to the size of the object. Here you will learn how the magnification is defined and how the magnification depends on the object and image distances.

- Place the light source near one end (say, the 0 cm mark) of the optical bench, and place the screen near the other end (say, the 100 cm mark). Use the cross hair as an object.
- Position lens #1 near the light source and adjust the lens position until you produce an image of the cross hair on the screen.

- Notice that there are two different lens positions that give focused images.
- Measure image distance i and object distance o for both these positions. Do you find them interchanged for these two positions? Why?
- Choose the lens position that gives the larger image. Determine the magnification: measure the size of the image with a ruler. How many times larger than the object is the image? The ratio of image size h_i and object size h_o , is called the magnification M :

$$M = \frac{h_i}{h_o}$$

- Compare the value of i/o to the magnification M .
- Explain the result — think of the ray that passes through the center of the lens, as you can see in Fig. 3.

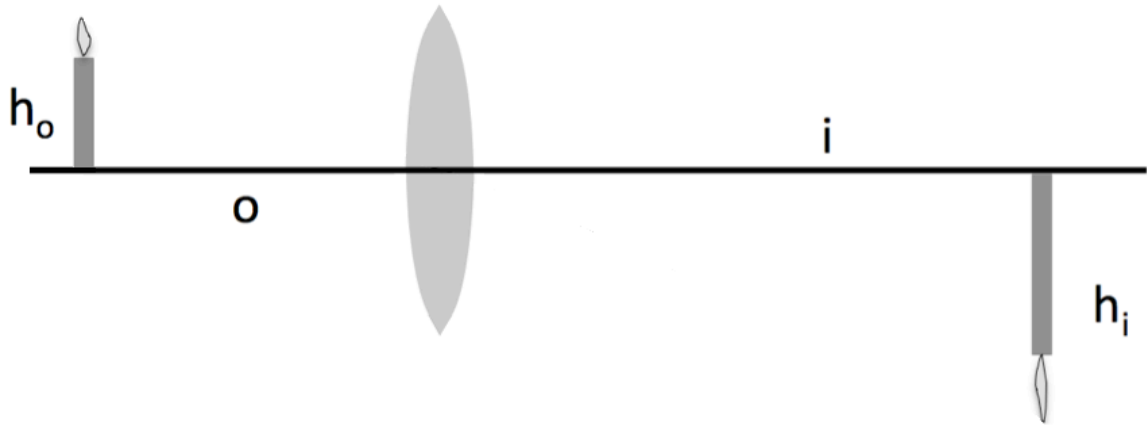

Figure 3

3. Lens Formula

The lens formula:

$$\frac{1}{f} = \frac{1}{o} + \frac{1}{i}$$

relates the image distance i and the object distance o to the focal length f . Since we just measured these distances, and earlier we measured the focal length, we can see if things work out according to this equation.

- Use the object and image distances you measured above and calculate the focal length of lens #1 from the lens formula.
- Compare the result to the measurement of f you did at the beginning of the lab.

An interesting problem of practical importance is the question, how can I change the image *size*, for instance in a movie theater, without changing the image *distance*? Changing the image distance would require a different distance from the projection booth to the screen, a costly building project! So let us pretend that our screen on the optical bench is the movie screen, and that we want to make a larger or a smaller picture on the screen without moving the lens. The

answer is that we need to change the focal length of the lens. We now do an experiment to see how this works:

- Replace lens #1, which you used so far, with lens S. Keep the image distance the same as before, i.e., keep the lens holder and the screen in the same place.
- Change the object distance by moving the light source until you again get an image on the screen.
- Is the image larger or smaller? To understand why, make use of the fact that the focal length of lens S is smaller. The lens formula tells you which way the object distance changes if you use a smaller focal length, while keeping the same image distance.

Instead of using the lens formula, you also could have simply used the fact that lens S kinks the light rays more than lens #1, thus requiring a different object distance.

- In connection with Fig. 2, we discussed which way the object (light source) has to be moved if you put the screen closer to the lens. Try it!
- Use the lens formula to deduce what happens when you pick an object distance o that is less than the focal length f . Try it!

4. Depth of Field

In photography, depth of field refers to the extent to which objects at different distances from the lens are still in focus. If foreground and distant background are *both* in focus, we say the picture has a large depth of field. Here you will learn how we can change the depth of field.

- Illuminate the crosshair ruler on the light source. Place the screen at a distance from the light source. Place lens #1 between them. Adjust the lens position to focus the crosshair ruler on the screen. Now move the object back and forth and observe over what distance you can move the object before the letters become so blurry you can barely read them. This distance is called the "depth of field." Record the result in your notebook.
- Now place a small aperture over the lens. Has the depth of field changed?
- Try to understand the answer by drawing a ray diagram. In the diagram, which rays are removed by using the aperture? Why does this help the sharpness of the image?

Normally we draw the diagram such that the rays focus on the screen. But here we assume that the screen is in the *wrong* place, so that the rays make a smeared-out disc on the screen rather than a sharp point.

Once you understand this, you understand why changing the **aperture** on a camera changes the depth of field. In turn, changing the aperture changes the diameter of the lens used.

5. Chromatic Aberration

Dispersion refers to the fact that light of different wavelengths has different indices of refraction. Correspondingly, different spectral colors are kinked by different amounts by a lens, causing the image distance to be a little different for blue and red light. Thus, if you want to take a photo of a flag in your notebook and focus the camera on the red stripes, the blue field will be slightly out of focus. This is referred to as *chromatic aberration* of a lens.

- Remove the aperture from the lens. Place a red filter over the light source and focus the image on the screen. Now place a blue filter over the light source and move the screen to focus the image. Did you have to move the screen closer to the lens or farther away?
- What color was kinked more by the lens, red or blue?

For camera lenses the chromatic aberrations are eliminated by gluing together two lenses made of different glass. One lens is strongly converging, the other is weakly diverging. The converging lens is made of glass with small dispersion; the diverging lens is made of glass with large dispersion. This way one can eliminate dispersion and thus chromatic aberration without canceling the net focusing effect. Lenses made in this way are called *achromatic* lenses. Even cheap cameras use achromatic lenses.

6. Compound Lenses

- Remove the light box from the optical bench and place it on a sheet of blank paper so that three (almost) parallel rays of light fall on the paper.
- Place the converging lens (use the one from the ray optics kit box) in the path of the rays and trace the rays of light on the blank paper with a ruler. Remember to trace the position of the lens as well.
- Using this ray diagram, determine the approximate focal length of the lens, and its Dioptric Power.
- Repeat steps (2) and (3), this time for a diverging lens (use the one from the ray optics kit box). Remember to place the diverging lens so that there is space on the paper to extrapolate the light rays "backwards" to obtain the focal point position.
- Now place the two lenses together so that they form a compound lens.
- Calculate the combined power of the compound lens (add the dioptric powers) and write in your notebook what you predict will happen if parallel rays of light were going through this compound lens.
- Try it. Record and explain what you observe, using your understanding of what the power of a lens means.

Lab 3: Photography

In this lab we ask you to use and analyze a typical digital camera to see how it works.

In particular you will learn about *focus*, *exposure time*, *aperture*, and *ISO*. A modern point-and-shoot digital camera will attempt to choose the focus, exposure, aperture, and ISO for every picture you take. If you want to take creative photographs, you have to know how to choose them yourself.

The camera measures focus, exposure time, aperture, and ISO in terms of numbers. In the first part of the lab we ask you to decide whether those numbers actually mean anything, or whether they are just numbers used for the sake of reference. In the second part of the lab we ask you to take photographs of the same scene using different combinations of focus, exposure time, aperture, and ISO. You will thus learn what is meant by depth of field, reciprocity, and graininess. These are some of the most important of the many measurable optical qualities in photography. We hope that after you do the lab, you have the desire to conduct further photographic experiments.

We also hope that after you complete the lab you will feel more comfortable that yes, after all, even digital cameras must follow the physical principles you have learned about this course!

Digital cameras vs. film cameras

For our purposes the most important difference between digital cameras and film cameras is the *light sensor*. In a film camera the image sensor is a piece of light sensitive *film*, a thin layer of plastic coated with certain chemicals that undergo chemical reactions when exposed to light. When a picture is taken, the piece of film is exposed to light in a controlled manner, using lenses, an aperture, and a shutter. After the picture is taken, you have to wind the camera to move the film to a chamber in total darkness inside the camera, so that it isn't exposed to any more light. If you wind the camera enough times, you reach the end of the roll of film and have to change it.

In most digital cameras, the image sensor is a *charge-coupled device*, or "CCD". A charge-coupled device consists of rows and rows of individual elements, called *pixels*. There are millions of pixels in a typical digital camera. When each pixel is exposed to light an electrical charge builds up in that pixel. When a picture is taken, the sensels are exposed to light in exactly the same controlled manner as in a film camera. After the picture is taken, the electrical charge on the sensels is read off by a miniature computer inside the camera, and stored in the miniature computer's memory. If you store enough pictures the memory becomes full, and you have to erase some pictures.

The camera: you will be using a Canon G7, a very nice point-and-shoot digital camera that was first manufactured in the fall of 2006. This camera can be connected to a computer and then controlled from the computer.

Experiments

1. Setting up the Camera

- Turn the computer and monitor on, and log in, so that you can see the desktop.
- Create a folder with your section number: This PC>Pictures>SectionXXX , and save images to this folder.
- Plug camera power cord in and turn on camera (on/off button is on the top).
- Connect camera to computer using the white USB cable (“Camera Window—Canon PowerShot G7” window should appear on computer screen).
- Click “remote shooting” tab.
- Click “Start Remote Shooting” icon.
- Click “OK”.

The Remote Capture Task window should now appear, showing the live preview:

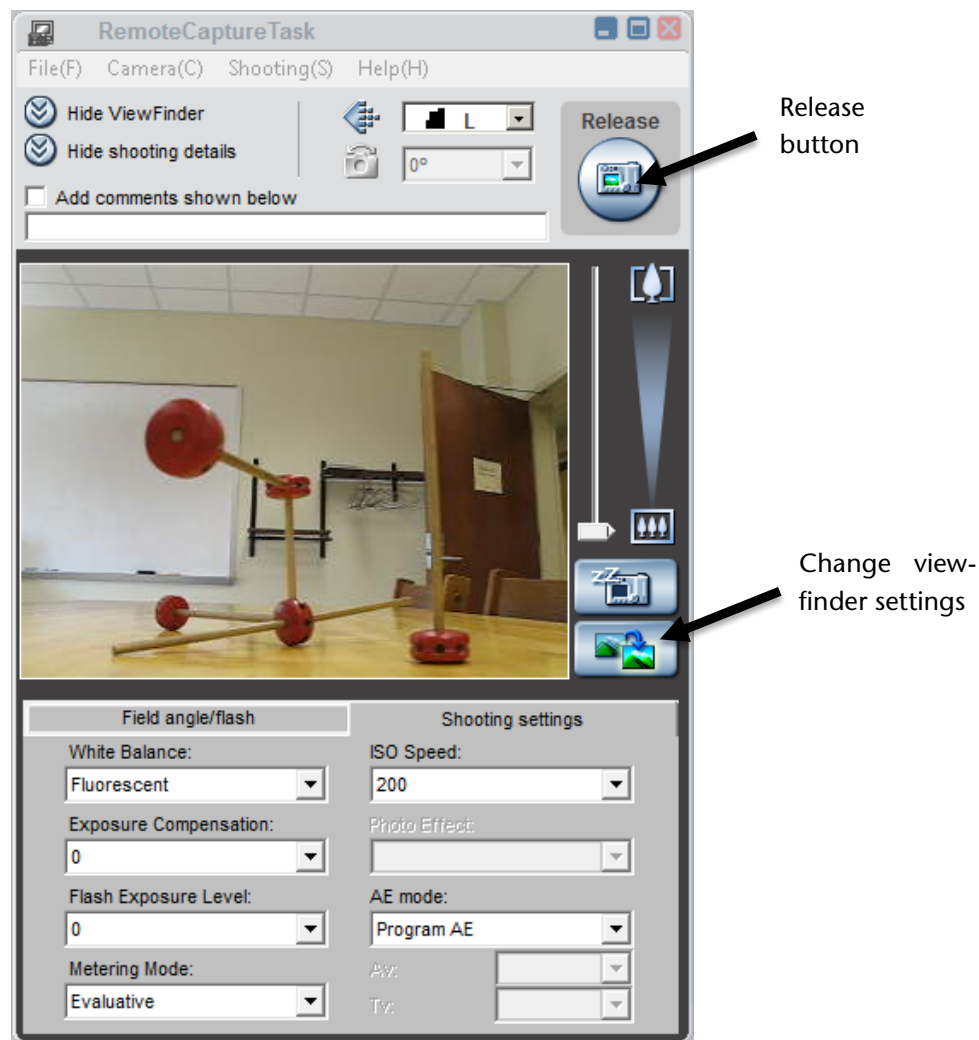

Figure 1: RemoteCapture Task window—live preview

- Under the “shooting settings” tab make the following entries:

ISO	400	Sets sensitivity of camera to light--to be discussed in part 6, below
AE Mode	Manual	Gives you full control over all camera settings
Av	4.5 (1/3)	Controls the camera aperture--we'll experiment with this in part 5
Tv	1/50	Controls the exposure time (measured in seconds)
White Balance	fluorescent	Not really important for this lab--feel free to play with it to see what it does!
Metering Mode	evaluative	Not really important for this lab--feel free to play with it to see what it does!

2. Pixels

If you look at a color picture taken by a digital camera closely enough, you will see that it is made up of a large number of tiny rectangles. These are called “pixels”. The more pixels are used in a picture, the smaller they are, and the more difficult it is to tell that they are there. But if you look closely enough, you can always tell.

- Press the “Release” button to take your first picture. The “ZoomBrowser EX” window appears automatically. Examine the picture following the instructions below.
- Click on the “Scroll Mode” tab in the Zoom Browser EX Window (see Fig. 2).
- Double click on the image you want to examine (a new window appears showing the image).
- Go back to the Zoom Browser EX window and click “Properties” which should now no longer be grayed-out (a new window appears called “Properties”).

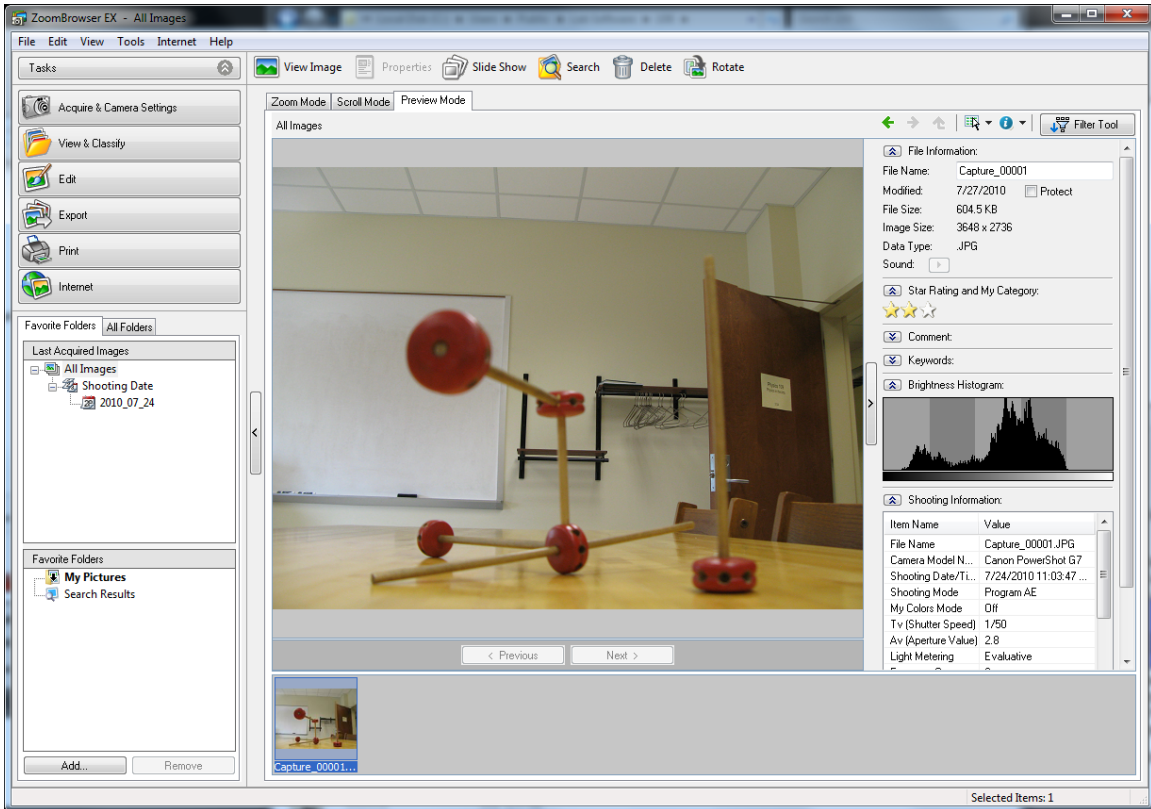

Figure 2: ZoomBrowser EX window

You should now see the two windows shown below.

- Use the slider on the upper left of the window with the picture in it to zoom in and out.

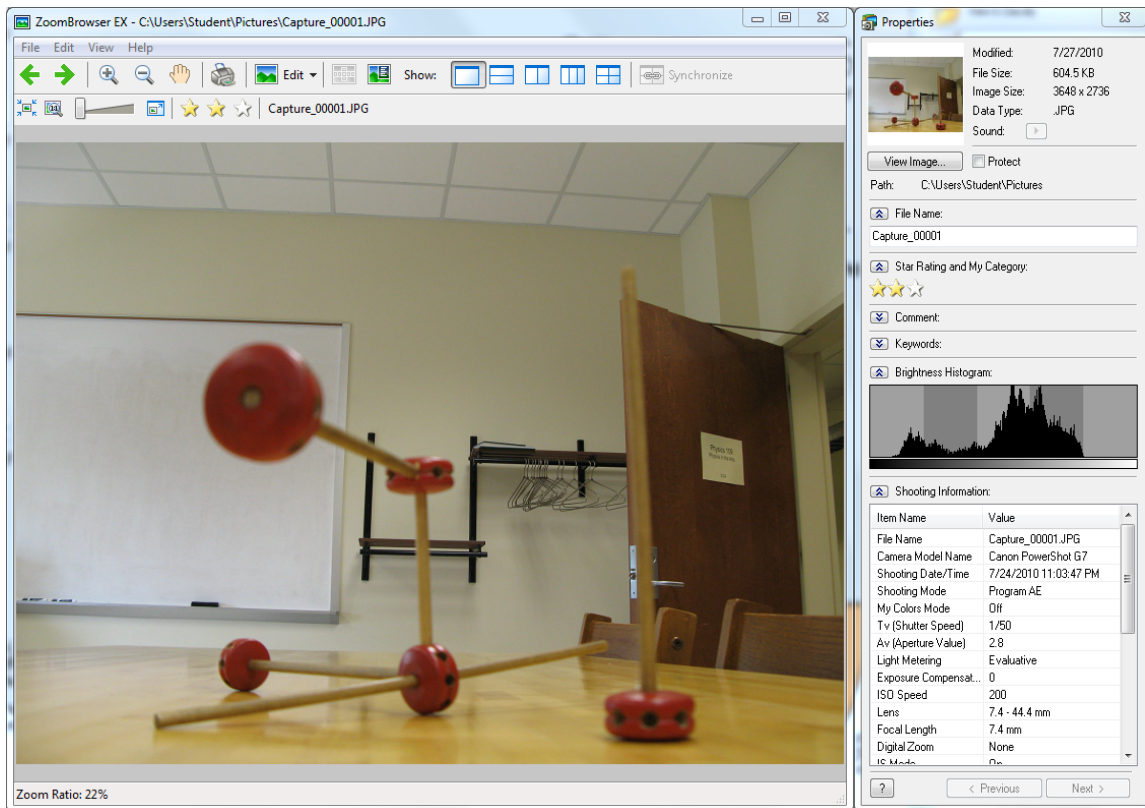

Figure 3: ZoomBrowser EX window, with Properties window

- Zoom in until you can see the pixels, and out again until you can't see the pixels any more. How many pixels do you think there are in the picture? Make a guess; then go to the properties window and scroll down until you see an entry labeled "image size"-- this will help give you the answer.

Each pixel has a particular color. The colors of the pixels on the screen are produced by adding different amounts of red, blue and green light in exactly the method you will learn about in the Additive Color Mixing lab later on in the course. If you were to print the picture out on a color printer, the colors of the pixels on the paper would be made by adding different amounts of cyan, magenta, and yellow ink. There is no one "right" way to figure out the proportions of cyan, magenta, and yellow ink that look the same as a given combination of red, blue, and green light, so people who are interested in making good prints on paper from digital color images spend a lot of time fiddling with the translation from red-green-blue to cyan-magenta-yellow.

3. Focus

- Before reading this section, write down the lens equation.

When you change the focus on a camera, you are changing the “image distance”—the distance from the lens to the image sensor—while leaving the focal length the same. This is done by moving the lens relative to the image sensor.

If the image distance is changed, but the focal length is not, this has the effect of changing the “object distance”—that is, the distance from the lens to objects that are sharply imaged on the image sensor. Can you explain why using the lens equation?. We say that an object that is sharply imaged is “in focus”.

Actually, digital cameras have many lenses inside them—some are necessary to avoid aberrations, others may be moved relative to each other so that the focal length of the camera can be changed. Changing the focal length of the camera is what you are doing when you use the “zoom”: “zooming in” on an object means increasing the focal length of the lens system in the camera. The zoom slider is to the right of the preview picture in the RemoteCapture Task window. Listen and watch while you move the zoom slider from one place to another, and you will hear and see the camera moving lenses around inside itself until it decides what is the best image distance for the picture. The focal length of the G7 can be changed from 7.4 mm to 44.4 mm. Increasing the focal length of the camera while keeping a particular object in focus increases the magnification of the object. Can you explain why? Can a camera focus on an object that is one focal length away from the camera? No!—that is too close. The image distance would have to be infinity.

- Make sure that the zoom is zoomed all the way out before continuing.
- Go to the “shooting settings” tab in the RemoteCapture window and make sure the “AE mode” is on “manual” setting, then go to the “Field Angle/Flash” tab, and set the “AF Operation” to “AF unlock”.

AF unlock	Camera chooses the best focus for the picture (by choosing the best image distance)
AF lock	Focus is locked (image distance is kept fixed)

“AF” stands for “autofocus”, and the AF unlock setting allows the camera to decide the best image distance for the picture. However, we want YOU to decide the best image distance.

- Place a lab notebook 30 cm from the front of the camera, and press the “change viewfinder settings” button.
- If the picture in the preview window now looks like it is in focus, then go to the computer and change the focus setting to “AF Lock”. This means from now on objects that are 30 cm from the front of the camera will be in focus. You shouldn’t hear any more whirring noises from the camera as it moves lenses around. If you do, that means the camera has gone back into “AF unlock” mode.

Note: if you use the zoom the camera will take itself out of AF lock mode, because it has to move lenses around in order to zoom.

You can always change the focal length of this camera by putting it back into AF unlock mode, pointing it towards an object a particular distance away, and clicking the “change viewfinder settings” button. Be sure the object fills the field of view. Don’t forget to put the camera back into AF lock mode once the focal length is what you want.

When it is time to take a picture, there are two ways to control the amount of light that is let into the camera: the *aperture* and the *exposure time*. The aperture is a hole through which light has to pass in order to make the picture. Making the aperture bigger lets in more light and making it smaller lets in less light. Most of the time the aperture is covered by a shutter so that no light gets in at all. When it is time to take the picture, the shutter is moved away, uncovering the aperture, and then moved back. The length of time the aperture is uncovered is called the “exposure time”. In the next two sections we will examine the aperture and exposure time.

4. Exposure time

There is big money to be made selling digital cameras, so you should not necessarily believe every camera specification you read. Here we will test the exposure time, using a light-emitting diode (LED), an audio generator, and a frequency counter (see picture). If you hook them together as shown in picture, the LED will blink on and off as many times a second as the audio generator tells it to (the frequency counter is just there to measure the frequency accurately).

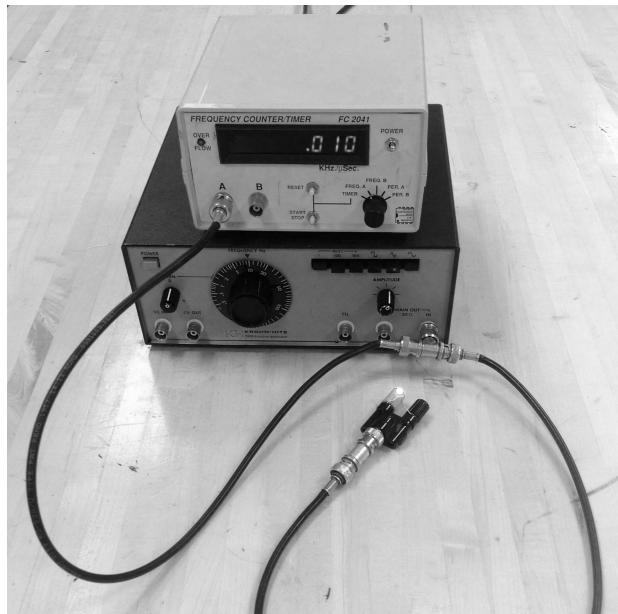

Figure 4: Blinking Diode Set-up

- Set the audio generator to 10 Hz (0.010 kHz). This should cause the diode to blink 10 times a second, which should be easily visible. Try increasing the frequency while watching the LED--how fast can it blink, while you are still able to tell it is blinking?

Once you have become comfortable with your blinking diode, try taking pictures of it.

- Set the exposure time (called Tv by the software) for the camera to 1/10 of a second, and ISO to 100. Set the audio generator to 60 Hz.
- Take a picture of yourself waving the diode back and forth in front of the camera. Make sure you move the diode from side to side. If you do this, the camera picture should show a number of clearly separated images of the diode--they should appear like a string of bright dots.
- Count the number of bright dots.

Compare this number to the number of flashes you expect to happen during an exposure time. For example, if you have the audio generator set to 60 Hz and the camera exposure time set to 1/10 of a second, you should expect to see 6 bright dots in the picture.

- Take pictures at a variety of exposure times, from very slow to very fast, while varying the audio generator frequency so that you get a reasonable number of dots.
- How many dots do you expect to see, based on the frequency and exposure time?

Do you get the right number of dots? Does the camera agree with the audio generator about time?

There is more than one way to make a blurry picture. As you've found, you can make a blurry picture if you use too long an exposure time to take a picture of something that is moving. You can also make a blurry picture by moving the camera while the picture is being taken.

- Hold the camera in your hands and take a picture. What is the longest exposure time you can use without making a blurry picture? Make sure not to rest your arms on the table when taking the picture!

5. Aperture

The aperture of a camera is the hole through which light has to pass in order for a picture to be made. The bigger the aperture, the more light gets in. Apertures on most cameras are measured in terms of focal length. Changing the size of the aperture is referred to as "setting the f-stop" (see below).

- Set the f-stop (remember, the software calls this Av) to 4.5 and take a picture of something on the tabletop.

Inspect the picture (remember, this means go to the ZoomBrowser EX window, click "scroll mode", and double click on the last picture you took). Then click "properties". In the middle of the long list of properties you should find "focal length" and "Av (Aperture Value)". The focal length might be something like 7.4 mm, and Av should be 4.5 (because that's what you set it to earlier!). This means that the diameter of the aperture should be the focal length (f) divided by 4.5. So right now the diameter of the aperture should be $7.4\text{mm}/4.5 = 1.6\text{ mm}$. Many cameras will actually write out the aperture using characters f and /: f/4.5 on another camera means the same aperture setting as 4.5 on ours. Also, many camera buffs describe the aperture setting by referring to the "f-stop": if someone asks you to set the f-stop to 4.5, you would turn the appropriate knob on many cameras to f/4.5 or, for our camera, set Av to 4.5.

If you get in front of the camera and look inside the lens, then you can see the aperture right in the center; you can't see anything behind it because the shutter is in the way. Look at a ruler and then look at the aperture—does it in fact look like the aperture is about 1.6 mm in diameter?

- Set the AE mode under “Shooting Settings” to “Program AE” and make sure the focus is set to “AF unlock”. Move your desk lamp in front of the lens while you look directly through the center of the lens at the aperture. You should be able to see the aperture getting bigger and smaller as the camera tries to decide what is the best size for the aperture. Can you see a difference in aperture size if you point the camera at something bright, as compared to something dark?

Remember that the amount of light that comes in through the aperture is proportional not to the diameter of the aperture, but to the area of the aperture. The area of the aperture is proportional to the diameter squared.

6. ISO

This setting controls the sensitivity of the image sensor to light. The higher the ISO number, the more sensitive the camera is. If you have ever bought film for use in a film camera, then you know you have to choose the proper ISO number for the film you buy, based on the pictures you intend to shoot. The ISO number of a piece of film is determined by the chemicals in the film. The number itself doesn't mean anything, but it does provide you with a relative scale: a picture taken with ISO 400 (for example) will be twice as bright as the same picture taken with ISO 200 (if the exposure time and f-stop are the same).

In a digital camera, on the other hand, there is no film, and the “ISO” is a made-up number that is supposed to be similar to the ISO for film. The “ISO” for a digital camera is like the volume control on a radio. If the incoming signal is very weak you can turn the volume control up so that you can hear it. This is the equivalent to a high ISO number. However, as you know, if you turn the volume control up, you are likely to hear a lot of unwanted noise in addition to the signal you want to hear. Visual noise is called graininess.

Digital cameras are clearly more convenient for taking pictures in the dark than film cameras are!

- Set the AE mode under “Shooting Settings” to “Manual”.
- Set the ISO at 400, set the exposure time at say 1/200 second, and take a picture. It should be a pretty dark picture. Call it picture 1.
- Now set the ISO at 1600, and take the same picture (picture 2). Much brighter. Good.
- Now change the ISO back to 400, and change the exposure time to 1/50 seconds. Take another picture (picture 3).

Can you see that picture 3 is just about as bright as picture 2, but has less graininess? Going to high ISO lets you take pictures in the dark, at the price of higher noise.

7. Exposure vs. Aperture—Reciprocity

We have already tested whether we think the exposure time settings correspond to reality. Now we are going to do another test to see whether the aperture settings are consistent with the exposure time settings: we are going to test the camera reciprocity. A camera has good

reciprocity if a picture taken with f-stop A_v and exposure time T looks just about as bright as a picture taken with f-stop A_v/n and exposure time T/n^2 . If you double the aperture diameter, you have to cut the exposure time to a quarter of what it was if you do not want your picture to look differently bright.

- Set the ISO to 400, the exposure time to 1/40, and the A_v to 4.5. Take a picture.
- Change the A_v to 4.0. Does this make the aperture bigger, or smaller? Take another picture.

Compare the two pictures. Which is brighter?

- Now change the A_v to 8.0, and change the exposure time to 1/10, and take still another picture.

Compare the last two pictures. Do they look equally bright? Are they exactly the same? If the camera is well-designed, the two pictures should look equally bright. You made the picture darker by making the aperture smaller, but you also made it brighter by increasing the exposure time. Why did you have to quadruple the exposure time in order to cancel out halving the aperture? The two effects should exactly cancel out for these two pictures. If they do, you have established that the camera reciprocity is good. If they don't, and one picture is brighter than the other, then you have established reciprocity failure, which means that either the aperture or the exposure time is not accurate for this camera.

8. Exposure vs. Aperture—depth of field

If you carefully compare the last two pictures you took, you may notice that the two pictures are not exactly the same, even if they are equally or similarly bright. They have different *depths of field*.

The depth of field of a picture is the range of distances over which objects in the picture are in focus. The smaller the aperture, the larger the depth of field. Absent-minded people who wear glasses likely know this. Such people sometimes lose their glasses, and then everything looks out of focus to them. One way they can regain sight is to make a pinhole in a sheet of dark paper and look through the pinhole. Since a pinhole is a very small aperture, everything seen through it looks in focus. (Of course, this will only work in a brightly-illuminated space, since the very small aperture also blocks most of the light!) Many a pair of glasses have been found by this method.

- Go to the RemoteCapture Task window and click the Field/Angle Flash tab. Unlock the autofocus ("AF unlock") and set Macro to On ("Macro" is the setting you use to allow the camera to focus on objects that are very close to the camera lens).
- Position the lab notebook so that it is 20 cm in front of the camera lens and click "change viewfinder settings". Then set "AF Lock". Now any objects placed 20 cm away from the lens are in focus.

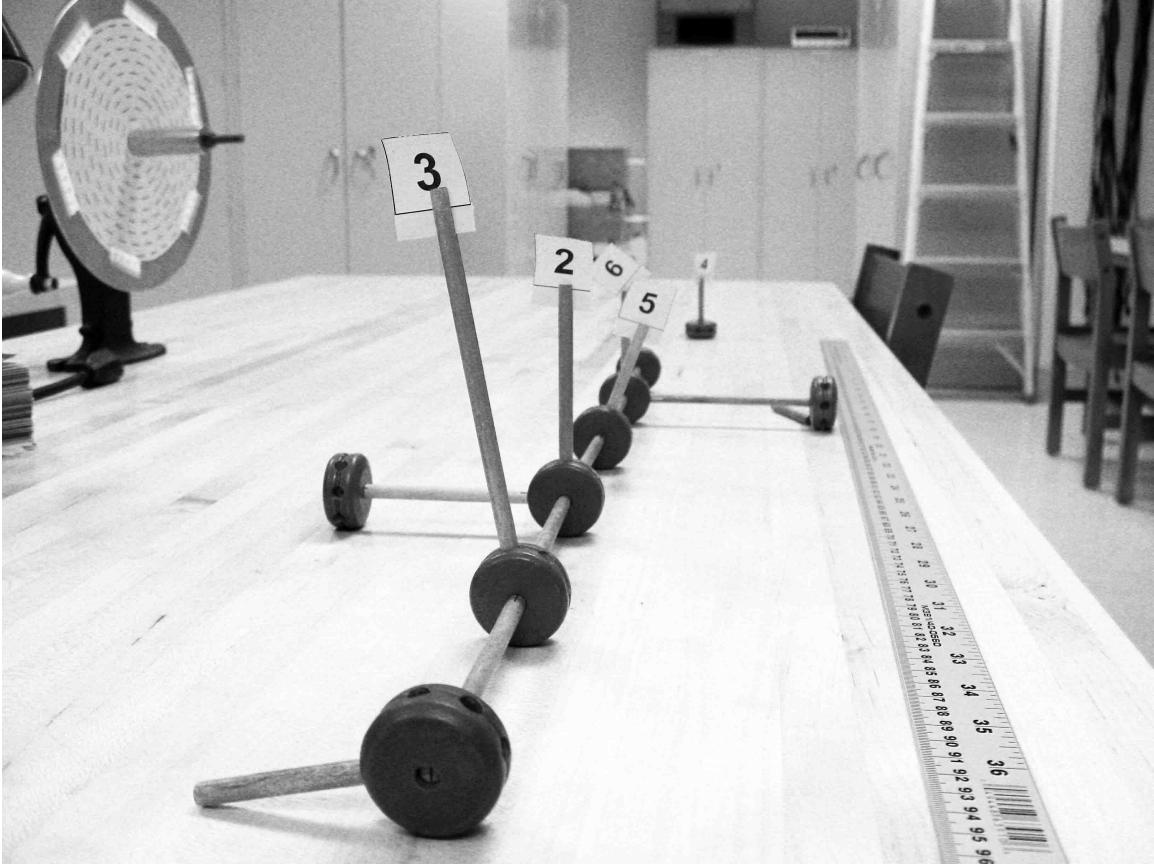

Figure 5: The Tinkertoy Axis

- Set up the tinkertoy axis so that one post is 7 cm from the lens, the next post is 20 cm in front of the lens, the next is at 33 cm, and the last is at 46 cm. In addition put a post at 1 m from the lens.
- Make a picture with a large depth of field: set the Av to 8.0 and the exposure time to 1/10 second.
- Make a picture with a small depth of field: set the Av to 2.8 and the exposure time to 1/80 second.

Can you see the difference in depth of field between the two pictures?

9. Have fun!

For whatever remains of lab time you are welcome to try to take creative pictures, whether of your fellow classmates, inanimate objects, or perhaps the natural world.

We hope that you are able to use the things you learned in today's lab when you next have a chance to take a photograph (using either a digital or a film camera). Good luck!

Lab 4: Additive Color Mixing

Introduction

The spectral colors extend from red to orange, yellow, green, cyan, blue, and violet. Other hues are not seen in the visible light spectrum and are therefore called *non-spectral hues*, or *mixed-only hues*. These include all of the magentas and purples, which can only be obtained by mixing lights of two spectral colors at opposite ends of the spectrum: blue or violet plus red lights.

The purpose of today's experiment is to show that you can obtain almost any hue by adding lights of three colors: red (R), green (G) and blue (B). R, G and B are referred to as **additive primaries**. The reason to prefer R, G, B as additive primaries is that the additive mixing of R, G, B allows us to produce the widest range of colors, that is, the largest area of the color triangle. We use three light emitting diode (LED) lights, each with a circular aperture in front of them, and then a lens to focus 3 circular spots of light on the screen. Place all three on top of one another, on the same spot of the screen, then imagine that this one pixel on the screen of your cell phone. Yes, a gigantic pixel, but one that behaves precisely like every pixel on your phone or computer screen, as these devices mix R, G, and B lights additively in each pixel of their screens to obtain any color, just like you do in this lab on a single, gigantic pixel.

The brightness of each spot can be varied by moving up and down one of three knobs, which change the current on the three LEDs and thus the brightness of each primary on the giant pixel. What makes this experiment interesting and fun to do is that we equipped each LED with a display that shows you the precise amount of each primary you are mixing, from 0 to 100. Thus, you can specify quantitatively the hue in your mixture in terms of the amounts of R, G, and B. These numbers form the basis of the science called **colorimetry**, which describes hues in terms of quantitative measurements.

A fourth LED light is white, and it is used to throw white light on the screen, or on a piece of colored paper, or through a colored filter of whatever hue you want to investigate. To investigate, for instance, the hue presented by brown wrapping paper, you would illuminate the wrapping paper with the white spot of light, and then match the hue by mixing R, G, B in proper proportion until the giant pixel looks just like the wrapping paper. You can, thus, specify the wrapping paper as being the equivalent of x units R, plus y units G, plus z units B. As an alternative, if you want to measure the hue of one of the colored transparent films that you have available with your equipment, you can place the film in front of the fourth projector and match the hue of the colored spot on the screen again by adding R, G and B.

Note that two of the primary colors (R, B) are found near the two ends of the spectrum, while the third is near the middle of the spectrum. Below, we will inspect the light from the three LEDs with a hand-held spectroscope and find that none of the LEDs we chose as primaries transmits any yellow light. Yet, you will be able to make a beautiful, intense yellow by mixing R and G! This should make it very clear to you that the eye does not act like a Fourier analyzer or like a prism that decomposes the light into the different wavelengths — rather there are many different combinations of wavelengths that you perceive as exactly the same hue. This is directly related to the fact that you have only three different types of color sensors (cones) in your retina, so that

two hues look exactly the same, no matter what wavelengths are present, as long as the two lights cause the same number of nerve pulses from each of the three types of cones to the optic nerve.

Equipment

The sliding dimmers control the current to each LED light, and thus their intensity, perceived by the eye as brightness. The display above the dimmers shows the amount of each R, G, B, and W LED lights.

Experiments

1. Hue, Saturation, and Brightness

First we do a few simple experiments to visualize the meaning of hue, saturation, and brightness, which are often abbreviated as HSB.

- Turn on the red and the green LEDs to make non-overlapping colored spots side by side. Adjust the intensity knobs all the way up.

We say that the two spots have the same perceived brightness or the same intensity. They differ in hue: one hue is red, the other hue is green.

- Look at the two spots separately, with a spectroscope. Get close to the screen when you look through the tube spectroscope.
- Now overlap the two spots — what hue do you see? Use the spectroscope and note the colors of the bands. Do you see the yellow hue by eye? What do you see when you look through the spectroscope at the mixed yellow on the screen? Which bands are there in the spectroscope? Why?
- Turn on the white LED light, and move it so that the white spot partly overlaps the green spot. Note that the hue has not changed — the spot still is the same kind of green — but the green has lower saturation, that is, higher percentage of white.

2. White

- Use the hand-held tube spectroscope to look at the spectrum of white light you obtain on the giant pixel by mixing the maximum amounts of R, G, and B lights. Get close to the screen when you look through the spectroscope, it works a lot better, and make sure that the fluorescent lights on the ceiling are off. Compare the spectrum to white light from the white LED light, and to the fluorescent light overhead or in the corridor just outside the lab if the light are currently off in the lab.
- Change the intensities of R, G, and B to 50 units. Did the color change?

3. Color Triangle or Chromaticity Diagram

Prepare a large (full page!) color triangle in your notebook, as shown in Figure 2.

- Label the horizontal axis “ r = Fraction of Red” and the vertical axis “ g = Fraction of Green” and carefully mark each axis with tick marks from 0 to 1.
- Calculate r and g for the mixed white light you obtained in 2. with intensities of R, G,

and B to 100 units, and plot the white point on the graph. Mark the point with W.

Remember: fraction of red means: $r = R/(R+G+B)$

fraction of green means: $g = G / (R+G+B)$

- Consider the color you obtained in 2. when you turned the intensities of R, G, and B down to 50 units. Where would this white be on the color triangle?

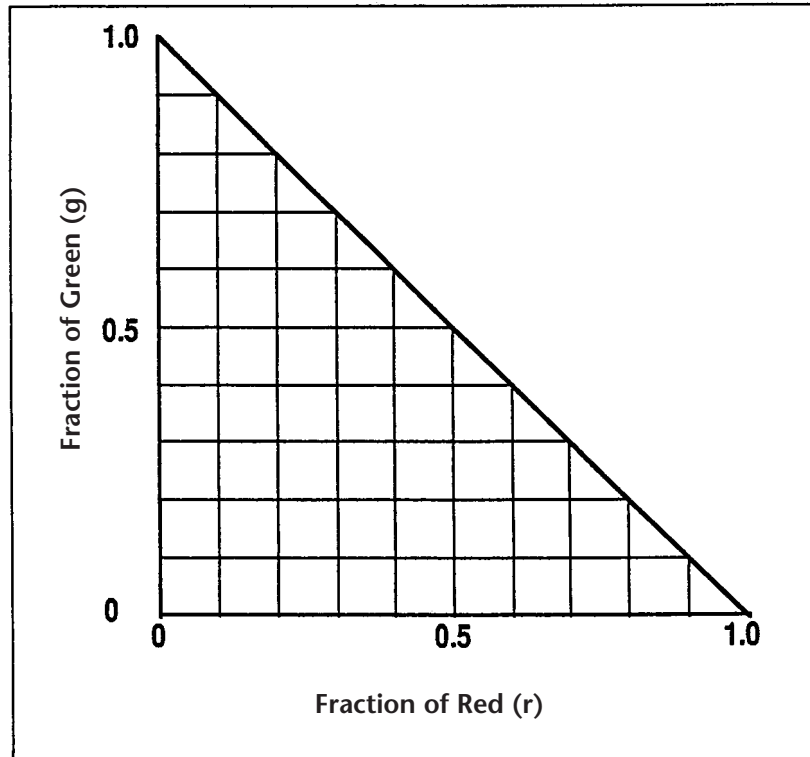

Figure 2

- The point to note here is that the location of a hue on the color triangle tells us only about fraction of red and green — thus only about hue and saturation. Which parameter is the color triangle not displaying?
- Note that once you know r and g , the fraction of blue b does not need to be plotted separately because it is just the complement to 1: $b = 1 - r - g$.

4. Locating R, G, B on the Color Triangle.

- Turn on the B light only, all the way up.
- What are the fractions r and g ?
- Plot the Blue point in the color triangle in your notebook and mark the point with B.
- Where would a less intense blue be located?
- Turn on G only, all the way up — calculate the fraction g , then place and label the point G on your graph.
- Turn on R only, all the way up — calculate the fraction r , then place and label the point R

on your graph.

5. Adding Two Primaries: Blue and Green

In each of the following cases, mark the corresponding point on the color triangle in your notebook.

- Add B and G in equal proportions. Calculate the fractions r and g and mark the corresponding point on the color triangle. Label the point with the name of the hue.
- Use two times more blue than green
- Use two times more green than blue
- Use blue only

Note the following on your graph:

- a) All mixtures of Blue and Green are represented by points along the line from Blue to Green.
- b) For equal intensities of Blue and Green, the point lies halfway between Blue and Green. If there is more Green than Blue, the point is closer to the point representing Green. If there is two times more Green than Blue, the point is two times further from the Blue point than from the Green point, i.e., the distances are in direct proportion to the mixing ratio. Check these relationships by looking at the points on your graph.

6. Red Added to Green; Red Added to Blue

- Add R and G in equal amounts.
- Calculate the fractions r and g .
- Mark the corresponding point on the color triangle in your notebook and write the name of the hue next to the points on the graph.
- Do the same by adding R and B in equal amounts.

7. Complementary Hues

Two hues are called complementary when their addition produces white.

- Add R and G in equal amounts — what do you see?
- What is complementary to the above hue? To answer, ask yourself what one must add to R+G to produce White.
- Move one projector so that the two complementary hues are seen side-by-side, with white where they overlap.
- Look at the color triangle in your book — where are the two complementary hues located in relation to white?
- What hue would you expect to be complementary to Red? And to Green? Try It!

8. Color Matching

Now we want to see if we can match any hue by adding suitable amounts of R, G, B. For this purpose we use the white LED light to project a spot of white light through a colored filter and match the hue by adding R, G, B.

- Choose one of the colored filters (pink, azure, orange, purple etc.), and project a spot of colored light using the fourth projector.
- Adjust the position of the R, G, B projectors so that the spots for the three primaries overlap into a giant pixel, right next but not overlapping the colored spot from the white light + filter.
- Adjust the amounts of R, G, B until the two colors match. Write down the three amounts. Describe in words the color you have matched.
- Repeat this process for one or two additional color filters.

9. Matching Pigments

- Illuminate a sheet of colored paper with the white LED light. Match the color of the paper by adjusting the intensities of R, G, B in your giant pixel.
- Describe the color in words in your notebook, and write its recipe in terms of R, G, B amounts.
- Repeat the process for paper of another color.

Lab 5: Subtractive Color Mixing

Visible light varies in wavelength from about 400 to 700 nm, of which — approximately — the regions 400-500 nm, 500-600 nm and 600-700 nm correspond to blue (B), green (G) and red (R).

Subtractive vs. additive color processing: If we shine two or three spots of colored light on the same area of a white screen (Lab 5) the stimulus received by your retina is the sum of the light sources. If you were to use blue and red spots of light, you would stimulate primarily Type 1 and Type 3 cones in the retina and you would see the surface as Magenta. This is called an additive process — the more light sources you add, the brighter the light becomes. If you add R, G, B in the right proportion you get white. But as anybody who paints knows, the more paints you mix, the darker the resulting color becomes. If you mix R, G, B paints you get nothing like white — rather, you obtain something icky-colored, muddy dark! The reason for this is that mixing pigments amounts to a subtractive process: R paint is red because it absorbs B and G, G paint is green because it absorbs B and R, so to understand what color the mixture has, we need to figure out what colors are *subtracted* or taken away from the white light illuminating each paint color, or the paint mixture.

Understanding color mixing is obviously essential for artists who mix paints, although many artists do it intuitively, from experience. Here, instead, we would like to understand the physical process. Besides painting, subtractive color processing applies to color printing, as in computer color printers, lithographic printing, and also in photographic printing. The simplest illustration of subtractive colors is obtained with color filters combined one after the other in front of a white light projector. Since we place the filters after one another, the first color filter subtracts part of the white light spectrum, and the second color filter subtracts some other part of the spectrum.

Equipment

Would you like to have a magic wand that you can point to a painted surface, and it would show you a graph of the light reflected by that surface at each wavelength? This would be analogous to a Fourier analyzer in the case of sound. You could point the wand at a light source as well, or at any colored surface to see what wavelengths are present.

Well, we were able to purchase this kind of equipment called a “spectrophotometer” for Physics 109. The wand contains a small optical fiber that captures the light and brings it to a sensor. The sensor in turn splits the light into its component wavelengths (similar to a prism) and displays the intensity for each wavelength on a computer screen. The surface you want to study is placed on the bottom of the box (Figure 1). The slot in the back allows you to slide a sheet of paper in and out of the box. This sheet of paper can be painted with different colors and color mixtures. The sample is illuminated with a 20 W halogen lamp. A filter holder allows you to place a filter between the lamp and a white sheet of paper to study the light transmitted through that filter. Placing two or more filters on top of one another will show you how subtractive color mixing works.

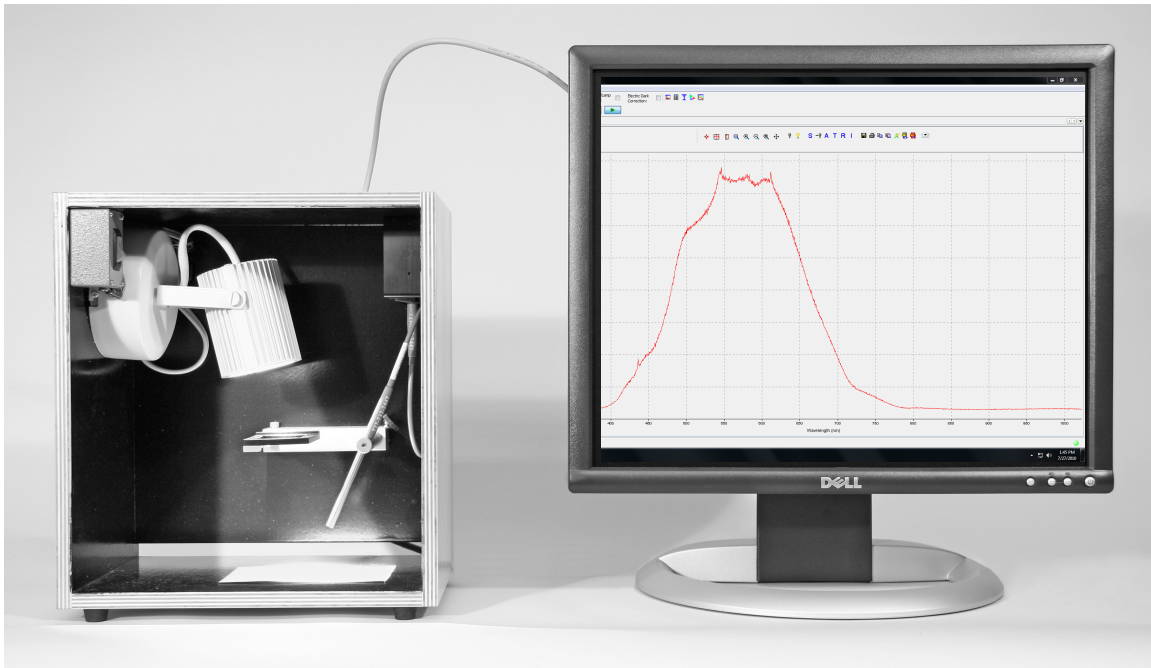





Fig. 1. The probe looks at the light diffusely reflected by a small spot, which is illuminated by the lamp. The spectrophotometer is connected to a computer that displays the intensity of light reflected at each wavelength by the surface at the bottom of the box.

Experiments



Setting up the spectrophotometer:

- Open the “LabSoftware/109” folder. Start the “OceanView” software. If it does not recognize the spectrophotometer, disconnect the USB cable from the spectrophotometer unit, then reconnect it. If it fails again, ask your TA for help.
- Make sure you take the blue cap off the end of the spectrophotometer.
- Click the “manually set numeric ranges” button . Set the x-axis minimum to 400 and maximum to 700 in order to display the visible part of the spectrum (400 – 700 nm).
- Have the probe look at a white sheet of paper. After turning on your lamp, you will see the lamp spectrum displayed. To change the settings of the program click "Window", then click "AcquisitionGroup". The integration time shown on the screen is the acquisition time. You can adjust the integration time to get a light intensity of about 3000 (if the value exceeds 4000 counts, the spectrophotometer is overexposed). The settings that are usually already entered are: Integ. Time 30 msec, Ave 10, boxcar 10. This makes the spectrophotometer scan the light intensity continuously, acquiring the spectrum for 30 msec, and taking an average of 10 scans. The spectrophotometer measures the intensity in 2000 wavelength intervals — boxcar 10 lumps 10 channels into one to reduce light fluctuations. Feel free to play with these settings.

To set up the reference, click the lit light bulb icon: . A new window will open showing the percentage of light transmitted or reflected, compared to the (white) reference. This means that, by definition, white is considered to reflect 100% at all wavelengths. Then, turn off the lamp (or

cover the probe opening) and then select the darkened light bulb icon at the top of the screen: . Next, turn on the lamp and select the lit light bulb icon: . You will have to change again the x-axis range to 400 – 700 nm.

- Ideally, the graph should show 100% because, by definition, we consider white to reflect 100% R, G, B. But note two things: first, the light intensity of the bulb changes a bit with time, so that you may have to reset the 100% level by selecting again the lit light bulb icon. Second, different whites have different reflectances – try a different white, e.g. a page from your notebook. To define the new surface as “white” select the lit light bulb icon and the screen will again show 100%.
- Now you are all set – you can switch between the windows any time you like to see either the spectrum or the Percent Reflection.
- If you now use the probe to look at a colored paper, you will see how much of each wavelength it reflects compared to the white paper.

Practice using the    buttons (pause, single acquisition, restart) to freeze the graph, and removing the filters quickly (they can be damaged by overheating).

1. Experiments With Filters:

As a first step to understand *subtractive color mixing*, we start with *filters*, which we overlap, that is, place one after the other in the path of the light. Each filter *subtracts* part of the spectrum.

- If you use 1, 2, or 3 identical reddish-magenta filters, does the hue change? Use the plastic foil reddish-magenta filters. Place 1, then 2, then 3 filters on top of each other on the filter holder – the light of course gets dimmer as you add more filters, because more light is absorbed, but does the hue change? Yes! Describe the change in the notebook. Now try to understand why the hue changes: look at the spectrum of one, two and three filters on the computer, and figure out how the spectrum changes with a combination of filters. Sketch the spectrum for 1 and for 3 filters in your notebook. Hint: does the filter transmit more light in the red or the blue? Thus what happens with 2 or 3 filters?
- Dichroic filters: we have excellent (and expensive!) nearly ideal optical filters for the so-called additive and subtractive primaries. These filters pass almost all light in well-determined wavelength regions, while they completely cut out other regions. The hues of these “interference filters” are R, G, B for one set, and M, C, Y for the other.

One filter at a time: look in the spectrophotometer and draw in your notebook three graphs for the transmitted spectra of three filters. In each case, write (in words) which part of the spectrum (R, G, B) is *absorbed* (not transmitted).

Note that reasonable people might think that a yellow filter transmits yellow light. Well, what does the spectrophotometer tell you?

Two filters overlapped: when you overlap filters, the transmitted color is what remains, that is, all the wavelengths that are not absorbed by either filter. Take for instance a red filter on top of a green filter (try it!). It is a mistake to think of the transmitted light as R+G. Rather R absorbs G and B, G absorbs R and B, so together they absorb what? You could say that white light was R+G+B, but the R filter subtracts G and B, the green filter subtracts R and B, so in the end we

have:

White & red filter & green filter = no light.
(R+G+B) - (G+B) - (R+B) = 0 (actually negative B, but there is no such thing as negative light intensity!)

Conclusion: for subtractive color mixing, always ask what light is absorbed!

Now combine two of the “subtractive” filters: C, M, and Y. What color results?

The answers are found most easily if you think about what part of the spectrum each filter absorbs. A yellow filter absorbs what color? A cyan filter absorbs what color? If yellow and cyan are combined, what is absorbed? What remains?

Using those three filters, either one at a time or in pairs, what *six colors* are produced? State the results in your notebook!

- Does Blue and Yellow make Green? Artists often make this claim, but is it true? To study this question, first with filters (later with paint), combine B + Y “ideal” filters, on top of one another — show both transmission curves in your notebook and the result you got for both filters!

2. Mixing Paint

Many of you have painted, so you have some intuitive idea about what happens when mixing paints of different colors, but few — if any — of you would know why.

The answer lies in the observation that a pigment (paint) removes or absorbs some part of the spectrum and diffusely reflects other parts, just as a filter removes and transmits different parts of the spectrum. (Pigment is the technical word for the chemicals on the surface of an object that give the surface a particular color).

When you mix two paints, each removes (absorbs) some part of the spectrum, so, in combination, it is the part *not* removed by either that remains, and is seen as the resulting color of the mixture. If you mix two parts of Y and one part of M, the Y absorbs B, the M absorbs G but less so because you used less M than Y. So a lot of R and some G remain making it _____ (?).

Exercise in paint mixing: your TA will give you sheets of paper (see Experiments 3 and 4 below) and paint tubes to mix paint in different proportions and to show what the spectrum of the mixed paint should be.

After you have done the exercise, look at the paint samples with the spectrophotometer.

Do the paint samples behave as overlapped colored filters? For instance: does mixing Yellow and Cyan paint correspond to the color obtained by overlapping Yellow and Cyan filters?

Applications:

What you learned about subtractive color mixing is relevant to color film and color printing. In color transparencies the three layers are dyed yellow, magenta and cyan. Your experiment above shows you how the subtractive primaries (cyan, magenta and yellow) are combined to produce other hues, such as red, green and blue. The Kodak Color Handbook explains in more detail how

color film is developed to produce a colored image. In computer color printers, the three dyes are usually cyan, magenta and yellow. Black ink is also always present in an additional printer cartridge, since the mixture of C+M+Y does not produce a very good black.

3. Mixing pigments in acrylic paints: unequal parts of Y and M.

For each of the following paint-mixing questions, reproduce in your notebook the text (e.g. 2 Y + 1 M = ?) and the graphs below.

(1) The resulting color should be painted next to the question mark;

(2) the reflectance curve (spectrum) you obtained with the spectrophotometer from that color should be drawn in a graph, as shown below;

(3) name the color you obtained;

(4) notice the effect mixing each component of the mixture has on the color and on the spectrum.

a. Mix 2 parts of Y and 1 part of M.

$$2Y + 1M = ?$$

What is your result?



b. Divide the color you obtained into two portions, then mix one with K.

$$2Y + 1M + 0.2K = ?$$

What is your result?



c. Mix the other part with K and W.

$$2Y + 1M + 0.2K + 1W = ?$$

What is your result?



4. Mixing unequal parts of M and C.

a. Mix 2 parts of M and 1 part of C.

$$2M + 1C = ?$$

What is your result?



b. Divide the color you obtained into two portions, then mix one with K.

$$2M + 1C + 0.2K = ?$$

What is your result?

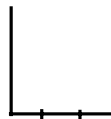

c. Mix the other part with K and W.

$$2M + 1C + 0.2K + 1W = ?$$

What is your result?

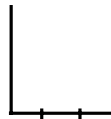

Lab 6: Oscillators and Resonance

An **oscillator** is something that **oscillates**--undergoes periodic motion. All musical instruments include parts that oscillate. For each oscillator, there is a restoring force, an equilibrium position, and a mass involved in the oscillation. These terms should be familiar to you from lecture.

In this lab we will investigate **harmonic** oscillators: those for which the restoring force is proportional to the displacement from equilibrium. We will encounter the **spring constant** k , and the **natural frequency** f , which are properties of the oscillator.

These will allow us to formulate what is meant by **resonance**, and to measure the **damping time** of an oscillator, which are both qualities of musical value.

Oscillators

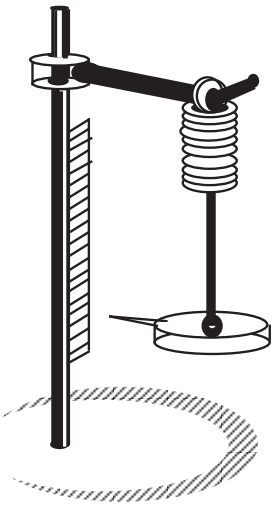

Figure 1

As an example of a harmonic oscillator, we use a weight suspended by a spring as illustrated in Fig. 1. When the weight is at rest, i.e. in a position of equilibrium, the downward pull of gravity and the upward pull of the stretched spring are in balance. When you pull the weight below the equilibrium position, the spring is more stretched, and its upward pull on the weight is larger than the downward pull of gravity. Conversely, if you were to lift the weight above its equilibrium position, the spring is stretched less, and its upward pull is less than downward pull of gravity. In either case the weight is pulled toward the equilibrium position: the spring provides a **restoring force**.

As you learned in lecture, a harmonic oscillator has two special properties: the oscillations are sinusoidal, and the frequency of oscillation is the same for small and large amplitude. These special properties result whenever the restoring force (F) is proportional to the **elongation** (x) of the spring (the elongation is the amount by which the length of the spring exceeds its unstretched length). This proportionality can be expressed as:

$$F = k x$$

which is called **Hooke's Law**. The k in this equation is called the **spring constant**.

1. Spring Constant

One way to find k is to measure the elongation of the spring, and the force (in Newtons) acting on the spring, and divide the force by the elongation. Another way of finding k is to measure the natural frequency (f) of the spring-mass oscillation:

$$f = \frac{1}{2\pi} \sqrt{\frac{k}{m}} \Rightarrow k = 4\pi^2 f^2 m,$$

where m is the mass in kg. We are going to find the spring constant by these two ways.

- Hang the mass hanger (mass = 5 g) from the spring. Adjust the scale so that the bottom of the mass hanger aligns with the 0 cm mark. The scale now measures the elongation of the spring.

- Add a 5 g mass, so that the total mass is 10 g. Record the total mass (in kg), and the resulting elongation (in meters) in the Excel spreadsheet SpringConstant.xlsx (shown below) on the desktop. Be careful to measure the elongation when the mass is at rest.
- Pull the mass down 1 cm, and release. Make sure the weight doesn't rub against the stand. Use the stopwatch to time 30 oscillations, and record in the spreadsheet. The spreadsheet then computes the period (T) and the frequency ($f = 1/T$).
- The spreadsheet then calculates k from the oscillations (using f and m).
- Add another 5 g mass, and repeat the steps above. To complete the table faster, you can ask your partner to add the mass and measure the oscillation time, while you fill in the table.

Note: 1 kg = 1000 g, 1 m = 100 cm, weight = mass x 9.8 m/s².

Total Mass (grams)	Total Mass (kilograms)	Elongation (meters)	Weight (Newtons)	Time for 30 oscillations (seconds)	Period T (seconds)	Frequency f (Hz)	k (Newtons/meter)
10							
15							
20							
25							
30							

- Average the spring constants from the last column, and report the value in your notebook.
- The spreadsheet also makes a graph based on Hooke's Law, using the weight as the force (F) that causes the elongation (x). Do your measurements fit on a straight line? If your measurements don't fit on a straight line, call over your TA.
- Assuming they do—find the slope of that line, which is the spring constant k of the spring. Write k (with the correct units!) in your lab notebook.
- Compare the values of k you measured from the two ways. Do they agree within 20%? To within 10%?
- Print the spreadsheet and graph, and tape into your lab notebook.

The result that heavier objects oscillate more slowly than light ones (if all other things are equal) has important consequences for the design of musical instruments. Although we will not explore this during the lab, if you are familiar with musical instruments you may well be able to guess correctly at some of these consequences.

Natural Frequency

Next, we will use a simple mechanical oscillating system to study the damping time.

The equipment we use is shown in Fig. 2. The oscillating system is a metal paddle, which can be set in motion by gently plucking it with your finger. To follow the motion of the paddle, a sensor is mounted near the top of the blade, which measures the strain on the oscillating paddle. The small signal from the motion sensor is amplified by a circuit housed in the oscillator box and is then observed on a computer.

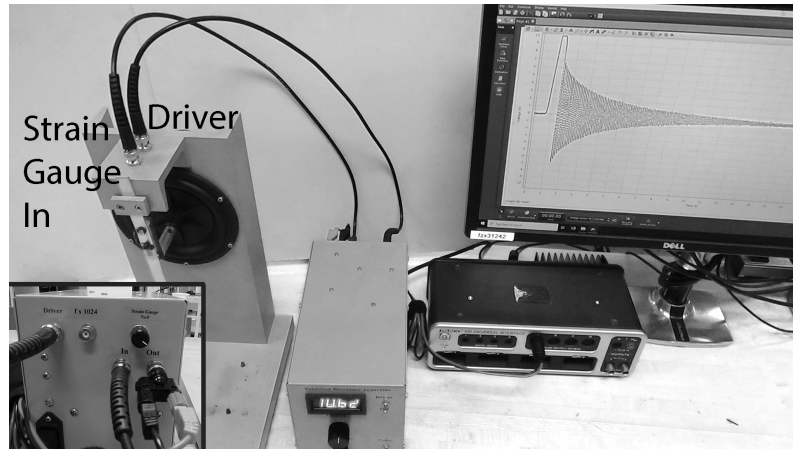
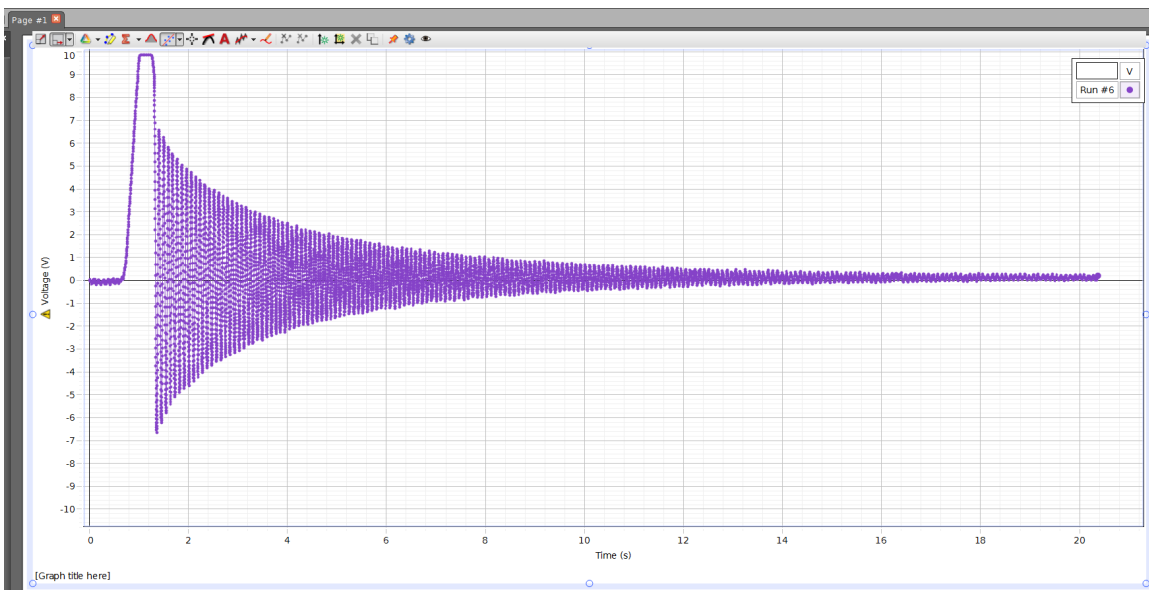

Figure 2

- Make sure the “power” switch on the driver unit is on. The “driver” switch should be off.
- Open “Lab Software/109” folder on the screen. Double-click on “blade-experiment.cap” to start Pasco Capstone.
- On the monitor screen should appear data from a damped oscillation, as shown below:



This window shows a graph of the elongation as a function of time. Time is measured in seconds, and the voltage from the motion sensor, which is proportional to the elongation, is measured in volts.

Some of the most useful buttons on the Toolbar for this experiment are:



the “Coordinates” button, which displays the displacement and time at any point;





the “Highlight” button, which enables us to select an interesting portion of the graph;



the “Scale to fit” button, which rescales the highlighted region or the entire oscillation pattern to fit in the graph window.

When you want to take data, press the "Record" button on the bottom left. While data is being recorded, the same button appears as the "Stop" button by which you can stop recording at any time.

Please make sure you have located all the above-mentioned windows and buttons before you start the experiment.

- Take the magnet assembly from the stand, and put it on the table far from the paddle.
- Click "Record", then pull the paddle back to the stop and set it into oscillation. Watch the oscillations on the screen. (You may need to adjust the "Strain Gauge Null" on the back of the driver unit in order to center the oscillations on 0 V). Click the "Stop" button to stop recording. To see the entire pattern on the screen, click the "Scale to fit" icon.
- Maximize the Capstone window, then click on the "Highlight" icon  on the Toolbar. A shaded rectangle should appear. Reposition the rectangle so it covers 12 oscillations. Click inside the rectangle, so its shading becomes darker. Now, press the "Scale to Fit" icon. The section you selected should now occupy the entire graph window.
- Create a "Show Delta Tool": click on the "Coordinates" icon , choose "Add Coordinates/Delta Tool", right-click on the square that appears, select "Show Delta Tool", and reposition the corners of the displayed rectangle as desired. The time difference as well as the voltage difference show up in the middle of the guide lines created by the dragging action (see picture on next page).
- Use the Show Delta Tool to measure the time taken for 10 oscillations, then find the period T and the **natural frequency** $f_N = 1/T$ of the oscillating paddle.

Time for 10 oscillations = _____ seconds

$T =$ _____ seconds

$f_N =$ _____ Hz

Damped Oscillations

No musical note lasts forever. When a piano key is struck, for example, the sound is at first (perhaps) somewhat loud, but as time goes by, the sound becomes less loud until it can no longer be heard. For every musical instrument, the loudness of the sound is proportional to the amplitude of oscillation of some part of the instrument. The *damping time* of an oscillation is the time it takes for the amplitude to decrease to half its original value.

In this setup, the damping is caused by a moveable magnet, which induces eddy currents in the metal of the blade; the eddy currents then react against the magnetic field that caused them, slowing the magnet down. The closer the magnet is to the moving blade, the larger the damping. Note that when the damping is large, the oscillations decrease rapidly, so the damping time is short; when the damping is small, the damping time is long.

1. Observation of damping (without using computer)

- Pull the copper paddle back to the stop, and let it go. Watch as the oscillations decrease.
- When the oscillations are no longer visible, put the magnet on the stand, so it is near the

paddle.

- Pull the paddle back to the stop, and let it go. Is there a noticeable difference in the way the oscillations decrease?

Now we use the computer to make a more accurate measurement of damping time.

2. Careful measurement of damping time

- Take the magnet off the stand again, and put it on the table far from the paddle. Press Record, pull the paddle back to the stop, and set it into oscillation. Continue taking data until the oscillations are no longer visible.
- The damping time τ is the time it takes for the amplitude to drop to half of its original value. In the picture below, the Show Delta Tool is properly positioned to measure the original amplitude, which is 1.615 V. Note that when the paddle is not oscillating—when the amplitude is zero—the motion sensor still outputs a voltage (0.141 V in this case). This is called an “offset”, and must not be included in your measurements.

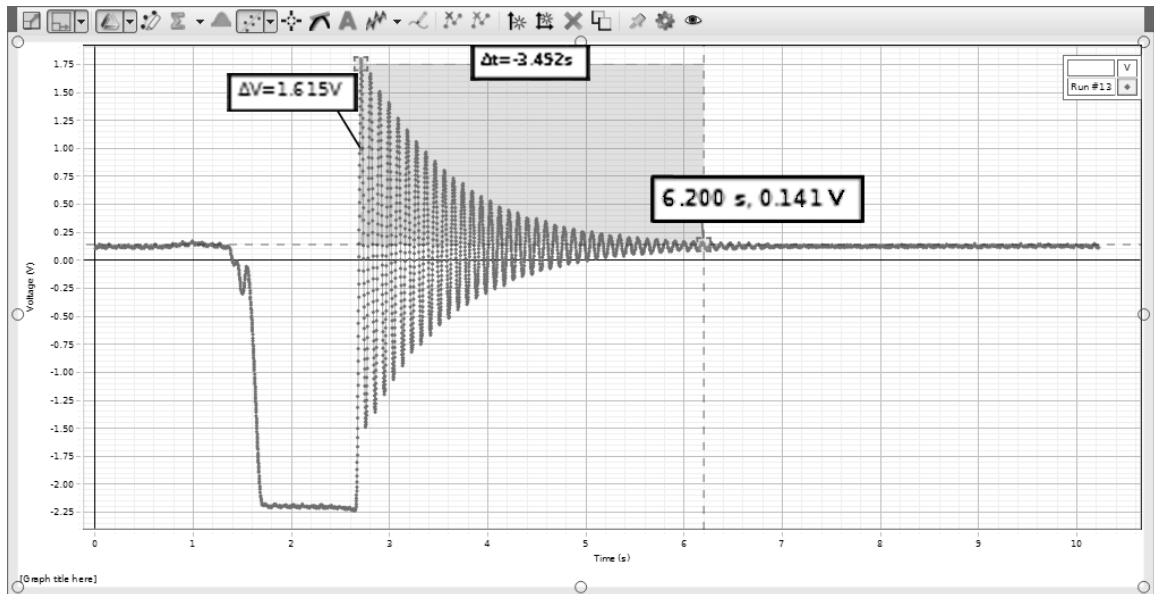

- Measure the damping time τ , and record your measurement in your notebook.
- Approximately how many oscillations occur during a damping time?
- Put the magnet back on the stand. Record the damping curve again, using the method described above.

A nice feature of the software—the DATA button —allows you to choose multiple data sets and compare multiple graphs superimposed on the screen. Try it out for the two magnet positions.

- How does the position of the magnet affect the damping time and the amount of damping?
- Did the change in the amount of damping affect the period of oscillation?

This completes our measurements of the damping time.

Resonance

The oscillating systems of some musical instruments can produce a sustained tone because they are kept in oscillation by a *driving force*. For a violin, for example, the bow provides the driving force, while the driving force for a trumpet is the airstream of the trumpet player. For many instruments the driving force is built up of many tiny, periodic “pushes” that are timed to correspond to the period of the oscillating system.

We devised a simple and inexpensive way to make a periodic push by using a loudspeaker whose membrane is connected to the paddle near the upper end. The speaker, in turn, is connected to a special low-frequency oscillator with a built-in frequency meter.

Resonance Curve

We will now sustain the oscillations, even though damping is present, by driving the oscillating paddle with the loudspeaker. It will turn out that oscillation amplitude changes when we change the driving frequency. Before taking any measurements, take a look at the oscillating blade while varying the driving frequency:

- Take the magnet off the stand one final time, and put it on the table far from the paddle, so the damping is small.
- Make sure the “amplitude” knob is set to zero (full counter-clockwise).
- Adjust the frequency knob (which is labeled “Hertz”) so that the driving frequency is equal to the natural frequency f_N that you just measured (it should be about 10.6 Hz).
- Turn on the “driver” switch on the driver unit. The paddle should remain motionless (because the amplitude of the driver is set to zero).
- Slowly increase the amplitude. If the paddle hits the stop, decrease the amplitude. You may have to wait a little bit to allow the amplitude of the oscillations to settle down. Make the amplitude as big as it can be without causing the blade to run into the stop.
- Very slowly vary the frequency of the driver from 8 Hz to 13 Hz and back. If the paddle runs into the stop, decrease the amplitude slightly, and start over. Notice that as the frequency is raised, the amplitude starts small, grows, then dies off again. This is an example of *resonance*. Make sure not to change the amplitude after this point.

Now, prepare to carefully measure the resonance curve, by recording the amplitude at different frequencies. On the Desktop find the spreadsheet Resonance.xlsx, which has rows and columns as shown on the next page. Note that f_N is the natural frequency that you measured earlier.

	Frequency (Hz)	Amplitude (V)
	$f_N + 1.0$ Hz	
	$f_N + 0.5$ Hz	
	$f_N + 0.2$ Hz	
	$f_N + 0.15$ Hz	
	$f_N + 0.10$ Hz	
	$f_N + 0.05$ Hz	
	$f_N + 0.02$ Hz	
	f_N	
	$f_N - 0.02$ Hz	
	$f_N - 0.05$ Hz	
	$f_N - 0.10$ Hz	
	$f_N - 0.15$ Hz	
	$f_N - 0.2$ Hz	
	$f_N - 0.5$ Hz	
	$f_N - 1.0$ Hz	

- Fill out the spreadsheet as follows. Have one person set the driver to the highest frequency, and the other start recording data. Watch the data as it appears on the screen: you may need to wait a little while until the amplitude stops varying. When the amplitude has stopped varying, use the Show Delta tool to measure the amplitude. See the figure below for an example: the amplitude is 0.767 V (=1.533 V divided by 2). Enter the amplitude in the spreadsheet, adjust the frequency down to the next step, and measure the next amplitude. It may be convenient for one person to adjust the frequency while the other measures the amplitude and enters it in the spreadsheet.

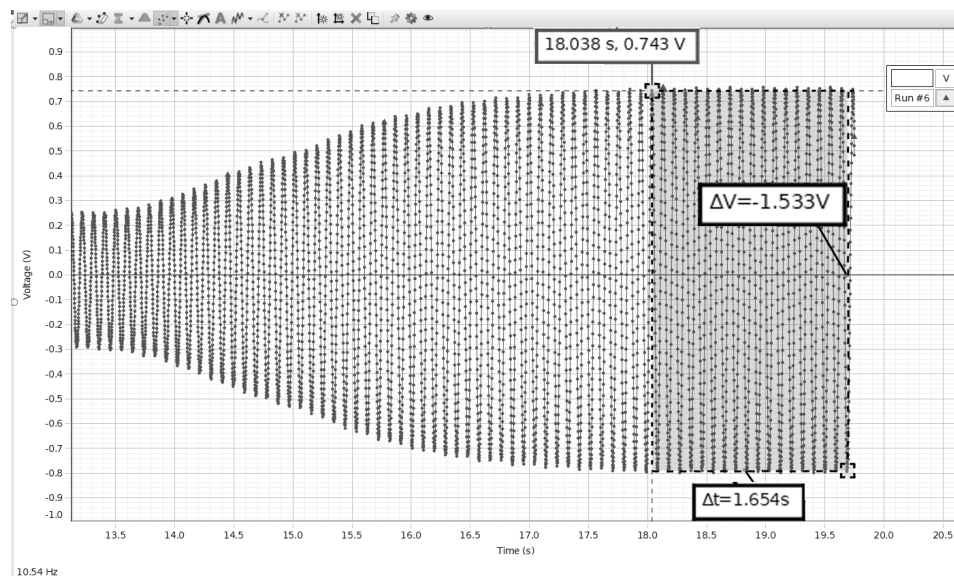

- Enter the measured amplitudes in the spreadsheet, and repeat the above step as necessary until the table is complete.
- The spreadsheet makes a graph of the results showing frequency on the horizontal axis and amplitude of oscillation vertically. Print out this graph.

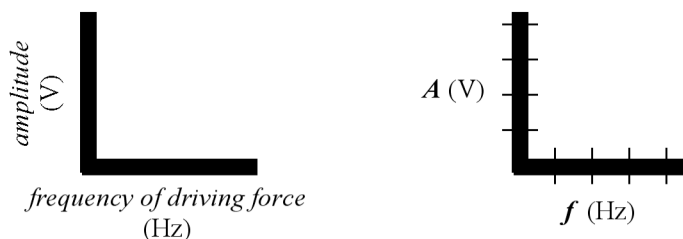

- Connect the points on the graph with lines, calculate the resonance width Δf —the difference in frequency between the half-maximum points—of the resonance curve, and record it along with the resonance frequency.
- Theory predicts the resonance width Δf and damping time τ are related by $\Delta f \times \tau = 0.4$ (if the damping time is long—large τ —the resonance width is small). Record in your notebook: $\Delta f \times \tau = \underline{\hspace{2cm}}$.

Note that the frequency at which the amplitude is maximum may be slightly different from the natural frequency f_N you measured earlier—there are several reasons why this might be so—but our measurement of Δf would not be affected by this slight difference.

However, because the frequency of maximum amplitude is shifted a little bit, there probably isn't a data point right at the maximum amplitude of the curve. This means it is likely that the estimate of Δf is a little larger than the correct value. If there were more time available in the lab, you can imagine that more points on the resonance curve might be measured, leading to a more accurate measurement of Δf .

Buildup Time of Oscillation

The sound of wind instruments or bowed strings does not start all of a sudden: it takes a fraction of a second for the oscillations to build up. If time remains, observe the buildup time as follows:

- Turn off the driver, set the driver frequency to f_N , and clear the screen. Click the "Record" button and then turn the driver back on.
- The buildup time is the time it takes the amplitude to reach half its final value. Measure the buildup time with the magnet on the table. Is the buildup time similar to the damping time?
- Now put the magnet back, and observe the buildup time. Which is faster—the buildup time with, or without, damping?

Lab 7: Strings

As early as several centuries B.C., artists made drawings of string instruments, many similar to the lyre and the harp. The guitar, the violin, and the piano are some common instruments that use the vibrations of strings to make music.

In this lab, you will have the opportunity to see and understand how strings move when plucked, bowed, or struck. You will observe standing waves and understand modes, of which all the more complex motions are composed.

Standing waves

When a string under tension is fixed at its two end points and then excited, it will vibrate like a guitar string when it is plucked; that is to say, the shape will change in a periodic way with the passage of time. Under some conditions, the resultant oscillations of the string are of a particularly simple nature. The shape of the string as a whole is sinusoidal, and every individual point on the string moves sinusoidally in time. When the string is oscillating in this way, we say it is one of its normal modes and that the oscillation is a “standing wave.” The shape of the string oscillating in various normal modes is shown in the figure below.

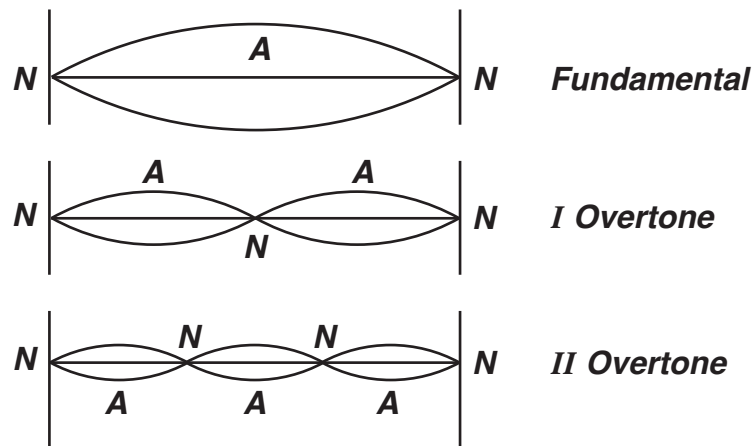

Figure 1

The points marked N in the figure are called nodes — these points are the only ones on the string that have zero amplitude, while the points marked A in the figures are called antinodes and they are the points on the string with maximum amplitude.

The first mode is called the fundamental, while higher modes are overtones of the fundamental. The usual way of setting a string into motion — plucking the string of a guitar or a harpsichord, or bowing a violin string — produces very complicated motions that can be represented as the simultaneous occurrence, or superposition, of many modes.

The frequencies of oscillation of the normal modes of the string depend on several physical properties of the string like the tension on the string, the length of the string and the linear density (mass per unit length) of the string. In today’s lab, we are going to establish the nature of this dependence.

Slinky Experiments

A slinky essentially acts like a string, but it is particularly easy to observe standing waves because the motion is slow enough to be followed by the eye. So, let's do the following experiments with the slinky.

1. Frequencies of Modes

- To make sure that the distance between you and your partner remains the same during the experiments, count the number of floor tiles between your toes and your partner's toes.
- Stretch the slinky between yourself and your partner. Make the slinky move in the fundamental mode by gently wiggling one end in a sinusoidal manner causing the motion shown in Fig. 2. You may need to gather some of the slinky in your hand to make this work--remember how much of the slinky you gathered in your hand so that later you can reproduce the same tension.
- Record the period T using a stop watch. It is best to time ten oscillations and then calculate the time for one oscillation. Now, calculate the frequency of the fundamental mode.
- Without changing your position, make the next higher mode and measure the new period. Then produce the third mode, and measure its period. Can you produce the fourth? If you can, measure its period also.
- Make a picture of each mode in your notebook and write the frequency next to each picture. What regularity do you notice in the frequencies of the modes?
- How does the fundamental change if you wiggle only half the slinky by holding it at exactly half of its length (see Fig. 2b), but keeping the tension the same? Record your results. How can you relate the frequency of the half-slinky to one of the modes of the full-length slinky?
- Which mode requires more effort to sustain the oscillation: higher modes or the fundamental mode?

2. Pulse on Slinky

- Make a pulse on the original length slinky with the original tension slinky (Fig. 2c). How long does it take the pulse to travel back and forth? Make five measurements and take the average.
- Compare the round trip travel time of the pulse to the fundamental period T . Write your conclusions in the notebook.

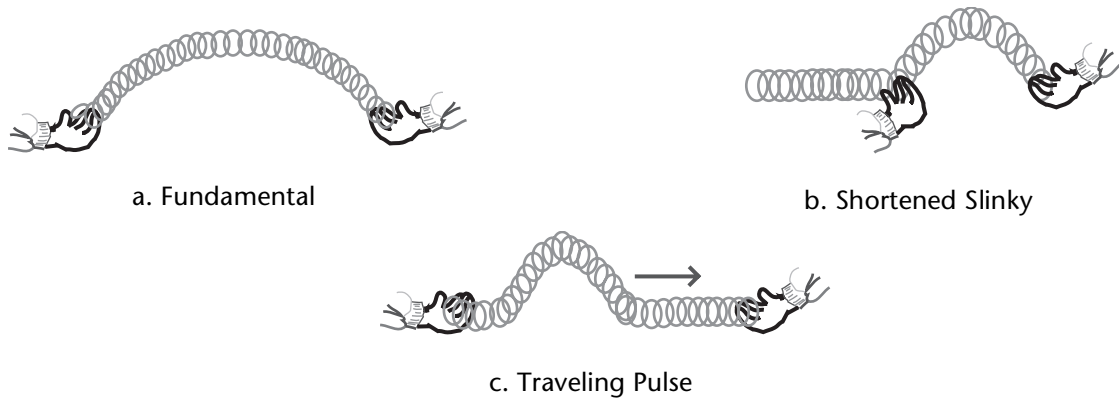

Figure 2

Experiments with String

The equipment we use is schematically shown in the photograph below. It is best to use a string that is comparatively slack, since this will produce nice, big oscillations. To make the string move in one particular mode, we want to push on it gently near one end in a sinusoidal fashion, just like you did when you made the modes on a slinky. Here, instead of using your hand, a loudspeaker, connected to the string near one end, provides the driving force. The speaker creates transverse waves that travel down the string and are reflected at the fixed end. The reflected waves travel back towards the speaker and add to the incident wave. For certain frequencies, the sum of the incident and reflected wave results in a “standing wave” pattern of nodes and antinodes. For all other frequencies the waves that are reflected back and forth fall out of step and the string moves very little.



1. Computer As Driver Control

From the Lab Software/109 folder on the desktop, DCLK on the “string-experiment.cap” icon, which opens the string experiment control shown below:

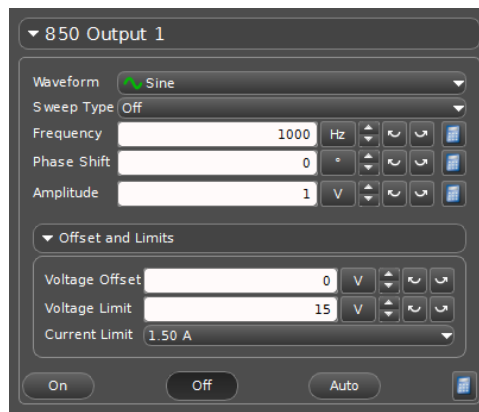

Figure 4

The control panel allows you to control both the amplitude and frequency of the signal sent to the loudspeaker, which essentially is the amplitude and frequency of waves on the string. When you CLK on the “ON” button, it sets the string into motion. The OFF button stops oscillations. **PLEASE DO NOT TRY VERY LARGE AMPLITUDES SINCE YOU RUN THE RISK OF BREAKING THE LOUDSPEAKER!!!!**

2. Finding the Fundamental Mode

- Hang some weight blocks at the open end of the string. Use a 50 g weight hanger and some weight blocks to make a total mass of 300 g to 400 g, which usually works nicely on our device.
- Start at a low frequency like 30 Hz. Increase (or decrease) the frequency by clicking on the appropriate arrow next to the “frequency control” on the control panel.

NOTE: Clicking on the “+” or “-” button changes the frequency in steps of 1 Hz. The arrows, left or right, change the frequency step size.

- Watch the string carefully as you change the frequency. At some frequency, you will see the string resonate and oscillate in the fundamental mode. Carefully adjust the frequency until the amplitude observed is the biggest.

Record your measurement of the fundamental frequency, and sketch the shape of the string in the fundamental mode, in a table in your notebook similar to the one shown on the next page.

3. Higher Modes

Based on the measured frequency of the fundamental, predict the frequencies of the first five or six overtones, and enter them in your table.

- To find the other modes, keep watching the string as you increase the frequency of the

driver.

- When you think you have reached a higher mode, record the frequency in your chart and see if it agrees with your prediction.
- Count the number of nodes for each mode.
- Try to find the first five or six modes. For a long string, some students find as many as ten nodes. Number the modes and record their frequencies. For each mode, sketch the shape of the string.
- What regularity in frequency did you observe from one mode to the next? Are the mode frequencies multiples of the fundamental frequency, as you were told in lecture?

	Sketch of mode	Mode number (n)	Predicted frequency (n x fundamental)	Measured frequency	# of nodes
Fundamental					
Second mode					
Third mode					
Etc.					

Note that the simple formula that says all modes of a string are exact multiples of the fundamental frequency is not quite correct for a string that has some stiffness to it.

4. The “Plucking Game”

For these questions, just try to work out the answers on the basis of what you know about the different modes (theoretical) — it will be difficult to verify them experimentally with the string you have in the set-up.

- If you pluck the string at the center, what are the modes that will be excited?
- What modes will be excited when you pluck the string:
 - at 1/3 the distance?
 - at 1/5 the distance?
- The different modes of a plucked string die down at different rates: right after plucking, there are many modes present, but the higher modes fade more quickly. After a while, only the fundamental remains and the sound of the guitar becomes close to the pure tone.

5. Changing the Length of The String

One common way of changing frequencies in string instruments is by changing the length of the string. For example, in the guitar, placing a finger next to a fret changes the length of the string by a corresponding amount, and this changes the frequency. Frequency depends inversely on the length of the string. So, the shorter the length, the higher the frequency.

- Use the bridge provided to reduce the length of the string — make it half of what it was before. Now, find the fundamental and next harmonic just as you did in the first case. Explain how the fundamental frequency is related to the length of the string.

6. Changing the Tension on the String

- Another way of changing frequencies in the guitar or the violin is by changing the tension on the string. Let us see how this works. Change the tension on the string by removing half the weight attached to it. How does this affect the fundamental frequency?

The frequencies of the different modes can be calculated using the string formula as shown below. This gives us an opportunity to verify the results we have obtained so far.

- The string formula is given as:

$$f = \frac{1}{2L} \sqrt{\frac{F}{\text{mass per unit length}}}$$

L is the length of the string in meters.

F is the tension or pull on the string.

Use this formula to calculate the fundamental frequency f and see if it agrees with your measurements. You can try this for any one combination of the length of the string and the tension on it.

To figure out the tension in proper units (called Newtons, N), you multiply the mass attached to the string in kilogram, by the acceleration of gravity which is 9.8 m/s^2 . Thus for instance, a 650 g weight would result in a tension of $0.65 \times 9.8 = 6.4 \text{ N}$.

The mass per unit length of the string we are using is $0.33 \text{ g/m} = 0.00033 \text{ kg/m}$.

7. Changing the Mass Per Unit Length of the String

The frequency of the string can be changed by changing the thickness of the string, more precisely, the mass per unit length of the string. Strings on musical instruments are made of several materials under different tensions. In today's lab, we will not be able to test the dependence of the frequency on the thickness of the string. Look at the piano or the guitar and note that strings of different materials and thicknesses are used. Bass strings are thick (large mass per unit length), strings for higher pitches are thinner. Whether thick or thin, strings on instruments are very taut (high tension) because this increases the force on the bridge and makes for louder, brighter tones.

Lab 8: Pipes

Many musical instruments you are familiar with are made of pipes of different lengths in which a sound wave travels back and forth. Some instruments have flared ends, mouthpieces, reeds. In some, the pipe has a set of finger holes (flute, clarinet, saxophone) and, in others, the pipe may be bent into the shape of a coil (tuba, french horn, trumpet, trombone), but they are still pipes. As such, they are subject to the physical rules that govern the propagation of sound waves in air. Our experiment is designed to give you an understanding of how pipes behave, and to help you make the connection between the properties of simple pipes and the sound made by more complicated brass and woodwind instruments.

In some respects, pipes behave almost like strings. When you excite the air inside the pipe at certain frequencies, you will see standing waves similar to the modes of strings. You will study the change in oscillations when one end of the pipe is closed off. You also will find that pipes with fingerholes show quite different properties. In particular, the modes are not at all equally spaced.

Equipment

We will first find the modes of a pipe. To do this, we place a small loudspeaker near one end of the pipe (see Fig. 1). For certain frequencies, the wave traveling down the pipe adds constructively to the wave reflected from the end of the pipe, creating standing waves — resonances. In an actual wind instrument, the oscillations of the air column are set in motion by a much more complicated mechanism which involves feedback between the airflow from the player and the oscillating air column.

To monitor the motion of the air column, we detect the pressure variations inside the pipe with a microphone. You can move the microphone along the pipe in order to sense the pressure variation at different points inside the pipe. You can find the nodes by moving the microphone along the pipe until you find places where there is no pressure variation. The microphone is small

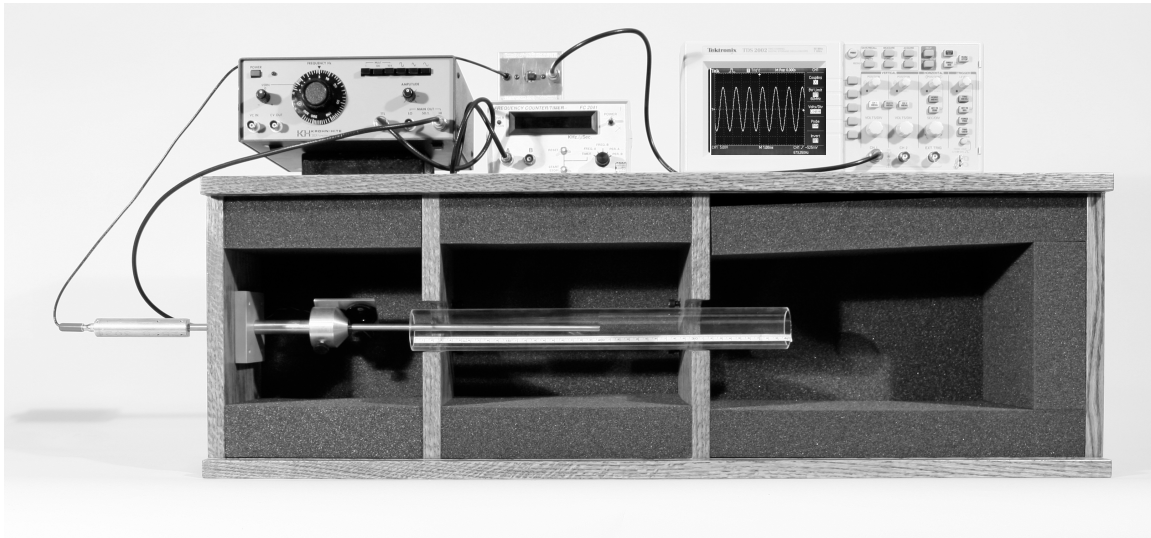

Figure 1

enough that it does not disturb the movement of the air in the pipe. A scale inside the pipe lets

you measure the position of the microphone.

The speaker, pipe, and microphone are all inside a sound-insulating box to protect them from outside noise interference. The speaker is connected to an oscillator that produces sinusoidal oscillations of a chosen frequency. The oscillator has a fine adjustment (called vernier frequency) labelled "VERN". The microphone is connected to an oscilloscope, which monitors the changes in air pressure inside the pipe.

An oscilloscope is a device for measuring and displaying electrical signals. The instructions for using our oscilloscope are in "Appendix: Using the Oscilloscope" at the back of the lab manual.

The amplitude of the microphone signal, measured by the oscilloscope, reflects the sound amplitude within the pipe, rather than the sound coming from the speaker. The sound coming from the speaker itself has pretty much the same amplitude for all frequencies. When the pipe resonates, you will notice a heightened response on the oscilloscope. This is how you can tell when you have reached a mode or resonance: the mode frequency is the frequency where the amplitude of the oscillations is a maximum. If you keep the lid of the box open, you will even be able to hear some of these resonances just by listening to the sound from the pipe.

Experiments

1. Modes of the Pipe

- Put the pipe into place. Make sure that the end of the pipe does not overlap the speaker. Use the long pipe with the small diameter. Place the microphone near the middle of the pipe (but not exactly at the middle, since some of the modes have nodes there). Make a table of resonance frequencies f , like you did for the modes in the Strings lab, measuring the frequencies of the first 5 modes.

Attention: You may have missed the fundamental. From your table, you will be able to guess where it is. The table should have the following columns:

	Sketch of mode	Mode number (n)	Predicted frequency (n x fundamental)	Measured frequency	Deviation
Fundamental					
Second mode					
Third mode					
Etc.					

- Are all of the overtones multiples of the fundamental frequency? Figure out what multiple of the fundamental frequency each consecutive mode's frequency is, and write it down in the third column. For the second and higher modes record the difference between the predicted and measured frequency in the "deviation" column.
- Now, locate the nodes and antinodes of the standing waves, by moving the microphone back and forth in the pipe for the first and fifth resonance frequency. Are the ends of the pipe nodes or antinodes?

2. Effect of Length and Diameter of the Pipe

- Compare the fundamental frequency you measured with the frequency given by the pipe

formula $f = v/2L$, where v is the velocity of sound in the air (344.7 m/sec at 70°F, increasing or decreasing by 0.3 m/sec for each 1°F increase or decrease in temperature respectively) and L is the pipe length, in this particular case, 60 cm.

Does the fundamental frequency you just calculated agree with the fundamental frequency you measured (and wrote in your table)? If not, for what value of L would the calculated fundamental frequency be identical to the measured one? In order to answer this question, you need to express L in terms of v and f , that is, you need to rewrite the formula given above as $L = v/2f$, and then use the measured value for the fundamental frequency f .

The value of L you obtained through the procedure outlined above is called the acoustic length of the pipe. The acoustic length is a bit larger than the physical length of the pipe because the nodes of the air oscillating inside the pipe always stick out a little beyond the ends of the pipe. The larger the diameter, the further the nodes stick out.

- How should the frequency of the pipe change, if the length of the pipe is changed? Use a shorter pipe and measure the fundamental frequency and the first three overtones. Find out if the frequencies and lengths of the two pipes are in inverse proportion. (Here's what you should do: Divide the length of the longer pipe by the length of the shorter pipe and record the value of this ratio. Next, divide the fundamental frequency of the shorter pipe by that of the longer pipe. Is this the same ratio?)
- Fat, heavy strings have a lower fundamental frequency than thin strings of the same length, with the same tension applied to them. (Now that you have already done the Strings lab, you should be able to explain why!) Is the same true for pipes of larger diameter? To get the answer, use a pipe of the same length, but a larger diameter, and measure the resonance frequencies. How do these compare to the ones you measured for the pipe with the smaller diameter?
- In what respects are the results with the pipes similar or different to those with the strings?

3. Closed Pipes

On the pipe organ, the bass pipes are closed at one end. Closing one end not only lowers the fundamental frequency, but also changes the pattern of overtones. All of the overtone frequencies are still integer multiples of the fundamental; but, they are no longer ordered as twice, three times, four times, and so on, of the fundamental frequency.

- Take the pipe you started out with and close it at the end that is away from the speaker. Place the microphone inside the pipe, near the closed end and measure the fundamental and the first three overtones. Make a table of the resonant frequencies as you did before.

	Sketch of mode	Mode number (n)	Predicted frequency (2n-1) x fundamental	Measured frequency	Deviation
Fundamental					
Second mode					
Third mode					
Etc.					

- What multiples are present?

- How does the fundamental frequency compare to the one measured for the open pipe of the same length? Give a qualitative answer (lower, higher) as well as a quantitative answer (by what numeric factor are the two frequencies different)?

4. Pipes with a Fingerhole

Woodwind instruments have fingerholes that change the effective length of the pipe and thus its fundamental frequency.

- Using an open pipe with a fingerhole, measure the resonance frequencies up to the fifth mode. Present the results in a table in your notebook.
- Are the modes still equally spaced (i.e. are each two neighboring modes still a fundamental frequency apart)? It will be easiest to see if you mark the resonance frequencies on a number-line. Make two such number-lines, one for the measured frequencies of the pipe without, and the other for the pipe with a fingerhole. For the pipe without a fingerhole, what is the pattern of overtone frequencies? Is this pattern similar for the pipe with a fingerhole?
- Using the procedure you are familiar with, find the acoustic length of the pipe with a fingerhole. Does the fingerhole act like an open end of the pipe? Explain why or why not.

5. Rise and Decay of Pipe Oscillations

A switch on the box lets you turn on and shut off the speaker sound suddenly, so you can study how the tone sound volume inside a pipe rises and falls off. This is, of course, of interest so that you see that musical tones from wind instruments do not turn on or off suddenly, even if the musician starts and stops blowing abruptly.

- Measure rise and decay time. To see the rise and fall, change the SEC/DIV setting to make a slow sweep – then turn the sound on or off, and, at the right moment, quickly press the START/STOP button to freeze the picture. It may take a few tries for you to hit the right moment. Once you have a picture stored on the scope, you can expand it with the SEC/DIV setting to look at the decay in detail (changing the horizontal position control).
- Relation to resonance width: a nice little project (Honors Students!) is to also measure the resonance width by tracing the resonance curve in small steps and compare decay time and resonance width (remember the Resonance Experiment!).

Lab 9: Musical Scales

A musical scale is characterized by a sequence of frequencies. As we go up the scale, the frequency keeps increasing. In this lab we study what special relationships there are between the different frequencies that make up the scale commonly used in western cultures. We will also study the difference between the just and the tempered scale and try to understand their musical advantages and disadvantages. As part of the lab you will learn a fair amount of terminology used by musicians. Among other things, you learn about transposition and about the difference between major and minor scales.

You might be tempted to think that any regular progression of frequencies makes a useful musical scale. To demonstrate that this is not so, we tune a keyboard such that the frequency changes from one white key to the next are all the same. If C is tuned to 200 Hz, this makes the next higher C 400 Hz. Since there are seven intervals between white keys within an octave, we simply divided the 200 Hz into seven equal intervals. If you play a tune like "Row Your Boat:" (C-C-C-D-E, E-D-E-F-G), and if you play chords like C-E-G, you will see that it sounds rather awful. Even though this scale is regular, to a musician it is quite useless.

Equipment

An electronic keyboard and a frequency counter will be set up for your use in this Lab (see Fig. 1).

Each key within one octave can be tuned separately. As you tune one octave, the other octaves are tuned automatically. Keys an octave apart always differ in frequency by exactly a factor of two. The frequency meter will measure the frequency if one key is pressed at a time.



Figure 1

The Just Scale

1. Tuning Triads

- Tune the second C key from the left to 240 Hz. Tune the keys C-E-G to the ratio 4:5:6. What frequency must you use for E so that $E/C = 5/4$? What must you use for G so that $G/C = 6/4$?

	C	D	E	F	G	A	B	C ¹	D ¹
1st Triad	240							480	
2nd Triad	240							480	
3rd Triad	240							480	
Just Scale	240							480	

Table 1

- Prepare a table in your notebook similar to Table 1 (shown above) and enter the frequencies of C - E - G in the shaded boxes in the table.
- Play the C-E-G triad together. Listen to it. Does it sound harmonious?
- Build another triad starting on G: G-B-D¹, again in the ratio 4:5:6. What frequencies did you come up with? List the frequencies in the Table.
- Finally, make a triad which ends on the upper C: F-A-C¹ with the ratio 4:5:6. You now have tuned a just scale. Listen to the triads one after the other. Are they all good harmonies?
- Now play "Row Your Boat" (C-C-C-D-E, E-D-E-F-G). Does it sound OK to you?

2. Sensitivity to Tuning

To most people, especially to musically untrained people, exact tuning only becomes important when one is playing chords. Here we want to test how sensitive YOU are to tuning.

- Play a chord like C-E-G. Then, without looking at the frequency meter, while playing the chord, de-tune the E until you can tell by listening that you are out of tune. Measure the frequency of E on the frequency meter. How many Hz did you change before you realized the E was out of tune? Repeat this a couple of times going higher and lower in frequencies. Record the results.
- Instead of a chord, play the tune "Row Your Boat" and de-tune the E until it seems clearly out of tune. How many Hz were you out of tune before you noticed? Repeat the test a couple of times.
- What do you conclude? Are you more sensitive to frequency inaccuracies when you listen to a chord or to a tune? Historically, the issue of tuning became important only when people started to play music involving harmonies (chords — polyphonic music).

3. The Black Keys of the Keyboard

- So far, you have only experimented with the three triads C-E-G, F-A-C, and G-B-D — a very limited selection! Suppose you want to make a triad starting on E. Calculate the frequencies you need and write them down.
- Look at your frequency table to see if E-G-B would do the trick.
- No — you need another key whose frequency is about halfway between G and A, called G# (pronounced G-sharp). Tune the black key to the right of G to the frequency you calculated. Now you can play a triad starting on E! Compare the sound of your new triad E-G#-B to the triad E-G-B, which you would be forced to play if you had only white keys.

4. The Missing Black Keys

- We now want to understand why the black keys are distributed in a particular way — note that there is no black key between E and F and between B and C. To understand why, calculate the ratios (in decimals!) of adjacent frequencies of the just scale on a calculator. Note: the ratios should be greater than one.
- Where are the large intervals? Where are the small ones? What function do the black keys serve?

5. Problems With the Just Scale

- If you play a melody in E instead of C by using G#, you may notice that some of the intervals do not sound quite right. Listen to the fifth D-A. Calculate its frequency ratio from your frequency table.

–Is it the perfect 6/4 interval it should be?

–Can you tell that it is off, just by listening to it?

The Tempered Scale

You can get around this problem by retuning the entire keyboard so that the scale starting on D is right, but that would not be very practical. Instead, we can use the tempered scale, where the entire scale is divided into 12 exactly equal half-tone intervals. To get to an octave after 12 semitones, the frequency ratio for a semitone must be 1.05946..., or the twelfth root of two.

- In Table 2, fill in the frequencies for each note of the tempered scale, given C=240, in the shaded boxes (use the method outlined in lecture).
- Set up a tempered scale on the keyboard using the based on C=240.
- Play a tune starting on C, then play one starting on D. Listen to the triads CEG and DF#A.
- To musically trained people, the tempered major third, such as C-E, sounds noticeably worse than the just major third.
- Copy the Just Scale based on C=240 from Table 1 into the shaded boxes.
- Tune E according to the Just Scale and the Tempered Scale using Table 2 and compare the sound of the major third C-E.

- Pitch memory game: tune C to 240 Hz and play a C. Then detune the C substantially. Without looking at the display, try to retune it exactly to 240 Hz. How close can you get?

	JUST SCALE			TEMPERED SCALE			
	Ratio	A=440	C=240	Ratio	A=440	C=240	
C	1	264	240.0	1	261.6	240.0	C
C#, D \flat				1.059	277.2		C#, D \flat
D	9/8 = 1.125	297		1.122	293.7		D
D#, E \flat				1.189	311.1		D#, E \flat
E	5/4 = 1.25	330		1.26	329.6		E
F	4/3 = 1.333...	352		1.335	349.2		F
F#, G \flat				1.414	370.0		F#, G \flat
G	3/2 = 1.50	396		1.498	392.0		G
G#, A \flat				1.587	415.3		G#, A \flat
A	5/3 = 1.666	440		1.682	440.0		A
A#, B \flat				1.782	466.2		A#, B \flat
B	15/8 = 1.875	495		1.888	493.9		B
C	2	528	480.0	2	523.3	480.0	C

Table 2

Transposition

The pitches of adjacent keys on the piano keyboard are separated by a “half-tone” (sometimes called a “semitone”, or a “half-step”). Two half-tones make a “whole tone” (sometimes called a “whole step”). Thus, if you look on the piano keyboard, you can verify that B and C are separated by a half-tone, but C and D are separated by a whole-tone.

1. Major Scale

If you play the white keys starting on C, you are playing the C major scale. You recognize the location of the half-tones from the location of the missing black keys. The major scale is characterized by the following sequence of intervals:

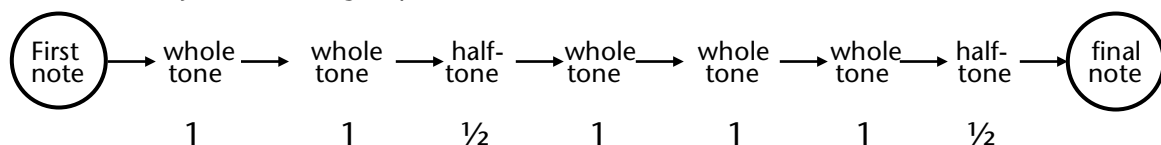

The final note is thus one octave above the first note.

- If you wanted to play the same-sounding scale in D, you would have to keep the same order of whole and half-tone intervals. What keys would you use? Write the D major sequence in your notebook, then play it.

- Do the same for E major.
- In musical scores, the symbol # indicates that the corresponding tone is to be raised by a half-tone. How many # are needed for a tune in A-major?

2. Minor Scale

If you were to play the white keys starting on A rather than C, you obtain the following sequence of intervals (check by looking at the keyboard and watching for the half-tone intervals):



This sequence of intervals characterizes the MINOR scale.

- Play the above sequence of intervals starting on C. Write the names of the tones in your notebook. This is called the C minor scale.
- Play "Row Your Boat" in C minor. Does it sound different than it did in C major?

Lab 10: Fourier Analysis and Musical Instruments

You may see these instructions on-line, as well as run the two applets used in this lab, by going to <http://www.physics.wisc.edu/instructional/phys109/Fourier> . You will need to have Java 6 in order to use the Fourier synthesizer.

A steady musical tone from an instrument or a voice has, in most cases, quite a complicated wave shape. The oscillations repeat themselves f times a second, where f is called the fundamental frequency. We have learned that f is related to the pitch of the tone. Tones played on different instruments sound different even if they play the same pitch because the wave shape is different — musicians say that the tones have different timbre or different tone color.

How does one describe wave shape? In **Fourier Analysis** we represent the complex wave shape as a sum of sine waves (or a sum of “partials”), each of a different amplitude. If the wave shape is periodic, the frequencies of the partials are multiples of the fundamental frequency and are called the “harmonics” of the tone being played. If the frequency of the musical tone is, for example, 200 Hz, the fundamental (also called “first harmonic”) has a frequency of 200 Hz; the second harmonic (also called the first overtone) has a frequency of 400 Hz; the third harmonic (or second overtone) has a frequency of 600 Hz; and so on. Many musical instruments, including voices, have ten or more overtones.

A **Fourier Analyzer** is a device that tells us how much of the various overtones are present in the sound that is being analyzed, i.e. it calculates and displays a graph of the amplitude and the frequency of the various harmonics. Expressed in popular terms, the Fourier Analyzer gives the “voice print” or the “sound spectrum” of any periodic wave shape you feed into it.

Fourier Synthesis

Our Fourier synthesizer produces a fundamental mode of a given frequency and higher harmonics. The amplitude and phase of each of these waves can be adjusted. Figure 1 shows a screenshot of the synthesizer.

Study the regions on the Fourier synthesizer. An oscilloscope display at the top allows you to inspect the synthesized wave shape. Below that, the amplitude of each harmonic can be adjusted between 0 and 1, and the phases can range from -180° to $+180^\circ$ phase shift. To listen to changes in the tone quality, you use a small loudspeaker or headphones.

1. Two Sine Waves of the Same Frequency

You will notice that the Fourier synthesizer has the ability to save a waveform and to show the current waveform (red) along with the saved waveform (blue) and a superposition of the two (green). This gives us the opportunity to study the wave shape that results when two waves are added — the questions of superposition. The simplest case adds two sine waves of the same frequency but different phase and different amplitude.

A point to remember when you are adding two sine waves of the same frequency is that the result of the superposition will depend on the relative phase of the two components being added. If they are in phase, the resultant sine wave will have large amplitude (the maximal

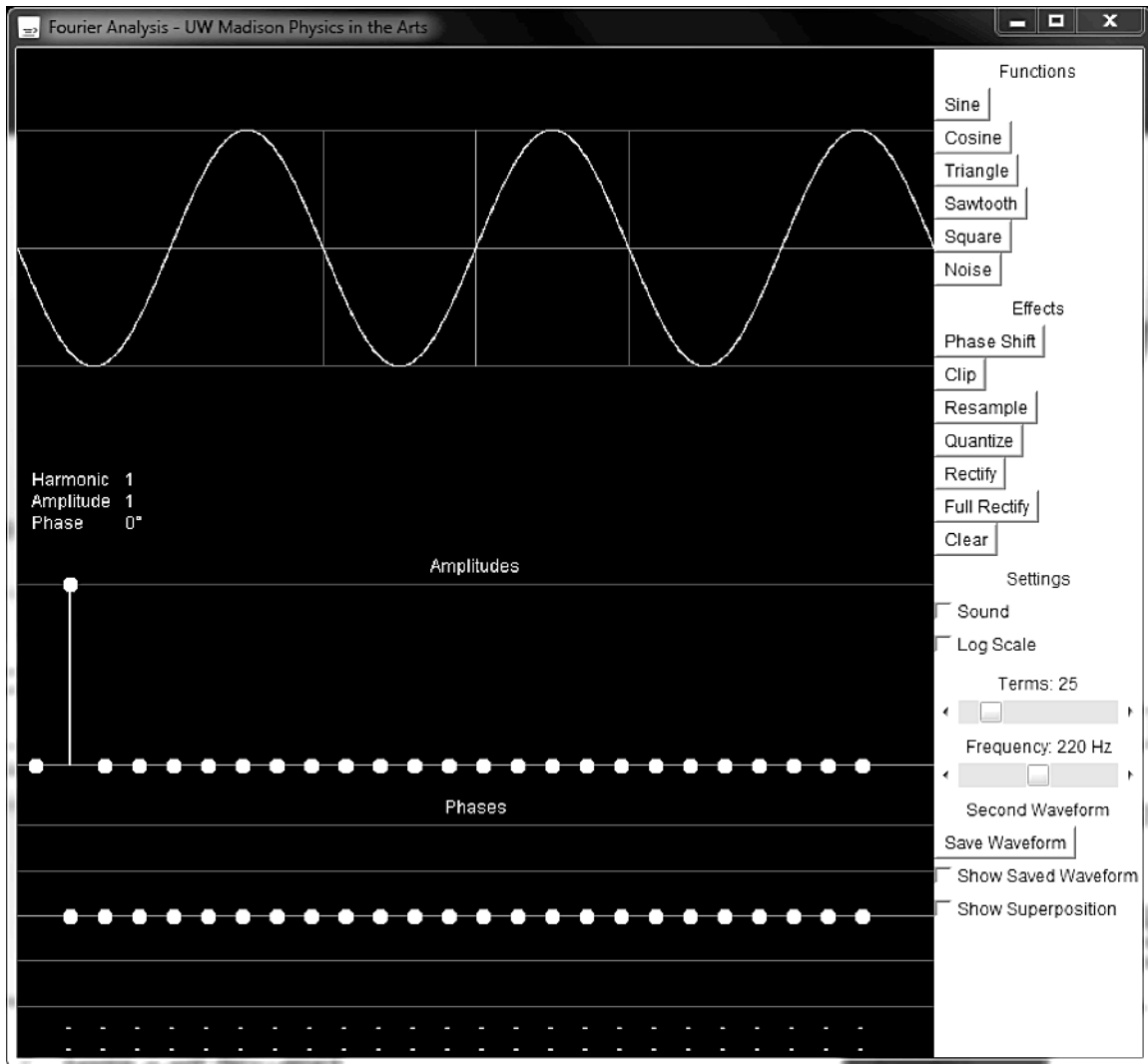

Figure 1

resultant amplitude that we can get). If the two superposed sine waves are out of phase, though, the resultant will have smaller amplitude. Exactly how much smaller depends upon exactly how much out of the phase the waves are.

- Click the SINE button at the top of the right column and then the SAVE WAVEFORM button near the bottom. Make sure the checkboxes for SHOW SAVED WAVEFORM and SHOW SUPERPOSITION are both checked. Vary the amplitude and phase of the current waveform. Listen to the sound.
- Can you make any statement that is always true about the wave shape that results, whenever two sine waves of the same frequency are added?
- Can you get the two waves to cancel one another?
- What are the three required conditions for cancellation?

2. Building a Square Wave from Sine Waves

The next part of the game is to build a square wave by adding harmonics. Look at it as a puzzle.

- Uncheck the checkboxes for SHOW SAVED WAVEFORM and SHOW SUPERPOSITION to display only the current wave on the oscilloscope. Start with the fundamental (Harmonic 1). Rather than just playing with the many different harmonics in the hope of making a square wave by luck, it is better to draw a big square wave in your notebook, and over it draw the sine wave that resembles the square wave as closely as possible.
- Next ask yourself what higher harmonic should be added to get closer to the square wave — would the second or the third harmonic do a better job, and how should their phases be adjusted compared to the fundamental? One thing to keep in mind is that the square wave is mirror symmetric about an axis (can you point it out?), and the waves you use to build up the square wave should be mirror symmetric too.
- Try it out! The oscilloscope pictures below might give you some clues. Use the mouse to adjust levels first to draw a rough square wave. Then, positioning the mouse over the amplitude you would like to adjust, use the up/down arrow (hold down the shift/ctrl keys for finer adjustments) to tune the components.
- Once you've created a decent square wave, use the table of the components to try to figure out the pattern of harmonics that creates a square wave.

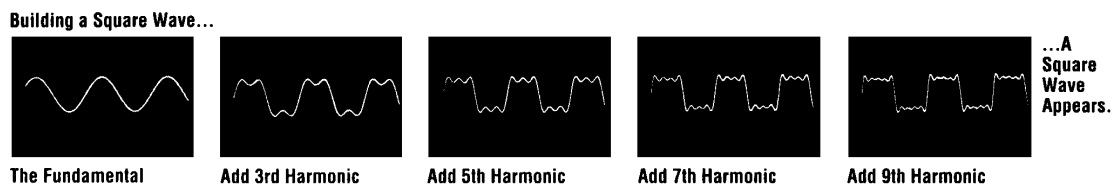

Figure 2

3. Does One Hear Phase?

Checking the sound box allows you to hear the waves as you change their properties. Using this, answer the following questions.

- Add two or more sine waves (for instance, harmonics 1,2, and 3) of amplitudes about three-quarters of maximum.
- Change the phase of one of them.
 - Does the wave shape change?
 - Does the sound you hear change?
 - Does the Fourier spectrum of the tone change?

This experiment shows why the Fourier spectrum is more useful to specify the tone "color" than the wave shape itself.

Fourier Analysis

1. Fourier Analysis of Sine Waves

In this part of the lab, we will get a taste of Fourier analysis by analyzing preset functions of the Fourier synthesizer. The preset functions are more convenient than musical instruments, or your voice, because they produce steady output whose frequency we can set accurately. We can also use the Fourier synthesizer to produce complex waveforms.

- Click the SINE wave function button in the right column.
- Look at the Fourier spectrum of the sine wave (amplitudes below the waveform). Does it look like you expect? (Note: Since it is a simple sine wave, there has to be just one component in the Fourier spectrum.) Read off the frequency and the amplitude of this component.

2. Fourier Spectrum of the Square Wave

- Now, click the SQUARE wave function button. The Fourier spectrum of this square wave is displayed.
- From the screen, measure the amplitude and frequency of each harmonic and write them down in a table in your notebook. Can you observe some regularity in the amplitudes and frequencies of the harmonics? Recall what you did in the first part of the lab, where you generated the square wave with the help of the synthesizer.

3. Fourier Analysis of Musical Instruments and the Voice: Introduction

This is done with a different applet. Go to:

<http://www.physics.wisc.edu/instructional/phys109/Fourier>

and you will see an on-line version of these notes. Scroll down to this section and you will find a link to an applet which you can download and run on your computer. Be sure a microphone is connected to the input of your computer. Get to know this applet by doing the following:

- Sing a steady tone into the microphone, for instance a tone like the “aah” in father. Watch the signal in the upper half of the screen and the Fourier spectrum of the tone in the lower half. Since it is hard to sustain the sound for the length of time needed to measure the spectrum, you can make use of another feature of the software. By clicking anywhere in the Fourier analysis window, you can freeze or release the waveform and frequency spectrum. You can then make measurements at your own pace. You may have to right-click (ctrl-click with one-button mice) to bring up a pop-up menu in order to zoom in on the chosen part of the Fourier spectrum to analyze the data.
- You can save the Fourier spectrum of your voice, if you want to. Try different tones and choose the spectrum you like best. Ask your TA to save it to a file for you. (Note: To save the Fourier spectrum, use the “Alt-Print Screen” key combination to capture the image of the Fourier Analyzer window. Paste the image into a graphics program such as Paint and save the image in BITMAP or JPEG format. You can then print or email the image file.)

Now do any of the following seven experiments, and write your findings in your lab notebook.

1. The Voice

The human voice is one of the most versatile musical instruments because we can change the physical characteristics of the instrument by changing, more or less at will, the rate of air flow and the shape of the throat and oral cavity. When we sing a tone, we are pushing air out of our lungs through the windpipe (Trachea, see Fig. 1), where the air passes through the narrow slot made by the *vocal folds* (often called vocal cords). The motion of the vocal folds is not at all harmonic, but rather the vocal folds rattle back and forth, producing puffs of air which have a large number of Fourier components (overtones). The puffs of air are the driving force which sets in motion the air in your throat and *oral cavity*. The oral cavity then amplifies some of these frequencies selectively according to its resonance curve. The resonance curve contains one or more broad peaks. The frequency regions which are amplified by the resonances of the oral cavity are called the *formant* of the voice.

A. Source of Sound

- The vocal folds are similar to the reeds of a clarinet which vibrate back and forth when a rapid airstream passes through the narrow gap between the reeds. To see how this works, hold two strips of paper together along one edge such that the small gap between the sheets faces you. Now, blow into the small gap between the sheets until the sheets start to vibrate, much as you may have done as a child with two blades of grass.
- Try changing the frequency of vibration by changing the tension on the paper or by blowing harder or softer. The buzzing sound you hear is not sinusoidal, but rather has many overtones of about equal amplitude.

Human Voice System

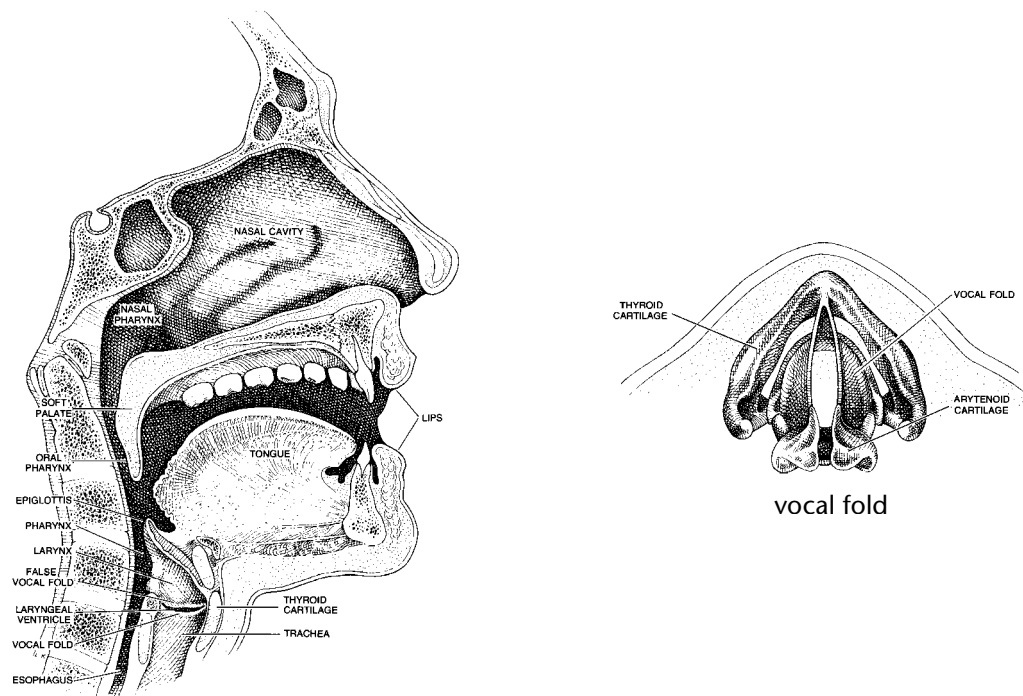

Figure 1

B. Formant

- Use one of the Fourier Analyzers set up in the lab to look at the sound spectrum of a vowel such as “aah” in “father.”

Note that of the many frequencies in the buzzing sound of the vocal folds, some frequencies are reinforced by exciting resonances in your oral cavity. The region of this resonance, i.e. the region of frequencies which are reinforced, depends on the shape you make with your oral cavity. The reinforced frequency region is called the **formant** of the vowel you are singing. There may well be more than one formant region, because the vibration of air in a cavity has several modes, as you learned in the Pipes experiment.

- List the frequency region of the formant in “aah” in your notebook.

C. Same Vowel — Different Pitch

- Now, as much as possible, keep exactly the same position of your mouth but increase the frequency of the vocal cord oscillation by singing the same “aah” at a higher pitch. Record a Fourier spectrum.
- Compare the two spectra and try to understand what is happening in terms of the two factors: vibration of the vocal fold and reinforcement by the oral cavity.

D. Different Vowel — Same Pitch

- Ask yourself how the Fourier spectrum should change if you analyze different vowels at the same pitch. If you keep the same pitch, did you change the fundamental frequency? Do you change the shape of your mouth and, therefore, the mouth resonances when you change from “aah” to “ooh” to “eeh?”
- Now do the experiment and look at the Fourier spectrum for the different vowels. Did you predict the outcome correctly?

2. Guitar

A piano has a separate string for each tone you play. Depending on the frequency of the tone, the string may be longer or shorter, thinner or fatter. String instruments that you can hold in your hand and carry around must be able to produce the tones of the musical scale using a small number of strings, such as four strings for the violin and six strings for the guitar. The same string is then used for an entire range of frequencies. In these instruments, one shortens the vibrating length of the string by placing a finger on the fingerboard. The frets on the guitar help the player to get the proper length of the string so that the tones are in tune, provided the strings are tuned to each other to start with.

The frets on a guitar are arranged so that the musician can change the frequency of a given string in half-tone steps to produce the tones corresponding to the tempered scale. The six strings on a guitar are tuned to E_2 , A_2 , D_3 , G_3 , B_3 , and E_4 .

A. Why Frets?

- A question about frets: frets help you play in tune, but they also have disadvantages and they are never used on violins. Can you think of any disadvantages?
- On the guitar, one places the finger not on frets but just beyond the fret – why? If you can't come up with answers, go on!

B. Placement of Frets

- Measure the vibrating length of an open string on a guitar. The term “open string” refers to a string without fingers on the fingerboard so that all the length of the string vibrates.
- To what new length would the vibrating length of the string have to be shortened to produce an interval of one octave above the open string? A fifth above the open string? A fourth above? Write down the answers in your notebook.

To answer this question, you may have to look up the frequency ratios of the octave, the fifth and the fourth in Table 2 of Lab 10, the Musical Scales lab (page 74).

- Now check to see if there are frets on the fingerboard in the corresponding places. On the fingerboard, the frets for the octave and the fifth are specially marked — what marks do you notice?

C. Semitone Intervals on Guitar

- A half-tone interval, such as G to G#, corresponds to a frequency ratio of about 1.06 – a six percent change in frequency. How large should the first fret spacing be if it is to raise the frequency of the open G-string by one semitone? Compare your estimate with the actual spacing of the first fret.
- Suppose you wanted to go up a half-tone, not from the open G-string, but from the first octave of the G-string: you are playing the first octave, which you measured above, and now you want to go up an additional semitone to G#. How wide should this fret spacing be? Measure it on the guitar and compare it to the spacing you found in the preceding question.

This example should teach you why the spacing between frets get smaller and smaller as you move along the guitar string to higher pitch. Ask your TA for help if you don't understand it.

3. Timbre of Bowed String — Violin

The process of bowing a string results in a waveform similar to a sawtooth which has even and odd harmonics present in decreasing intensity. Figure 2 shows an oscilloscope trace of the motion of a bowed string.

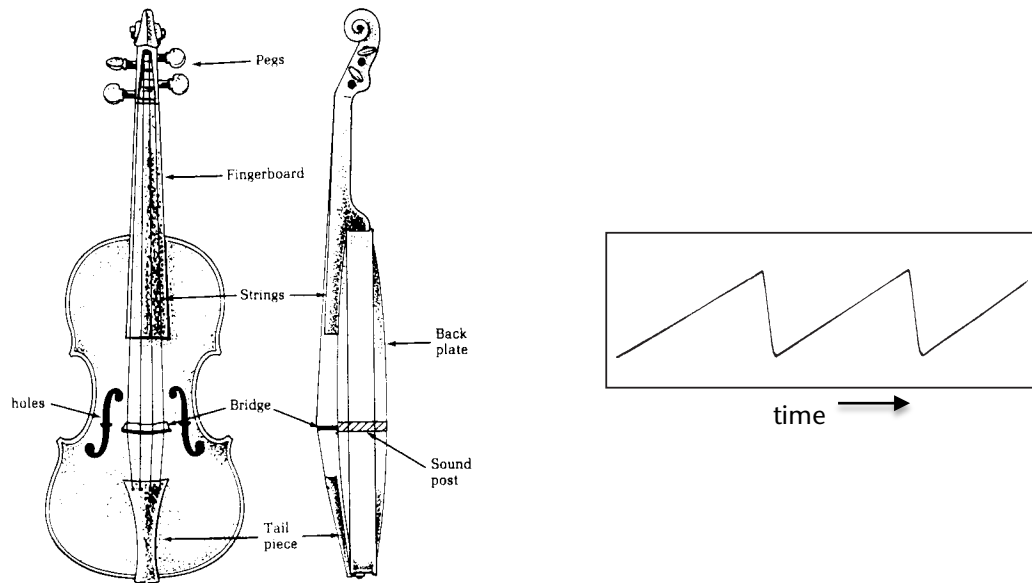
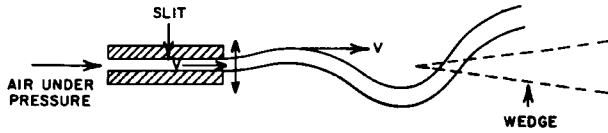

Figure 2

- Observe the Fourier spectrum of a bowed violin string. Are even and odd harmonics present?
- In what way does the Fourier spectrum change if you bow the string near the middle instead of near the bridge – are the higher harmonics stronger or weaker? Can you understand why?
- The violin body has an elegantly shaped hole to the left and right of the strings called the F-holes (Fig. 2). Are these holes for decoration only or do they affect the sound spectrum? To answer the question, compare the Fourier Spectrum with the F-holes open and taped shut. It will be useful to do this when you play a relatively low note and a higher note. Can you hear a difference in tone?
- In the end, please **carefully** remove the tape without damaging the varnish of the violin.

4. Piano Hammers

The striking mechanism of a piano is made up of a complex system of levers (see Fig. 3). The mechanism is designed to quickly move the hammer away from the string after striking it, and to make sure that the hammer doesn't bounce back and strike the string a second time.



a) An oscillating air stream

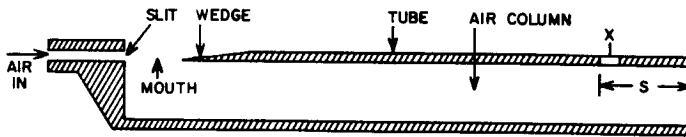

b) An oscillating air stream system connected to an air column

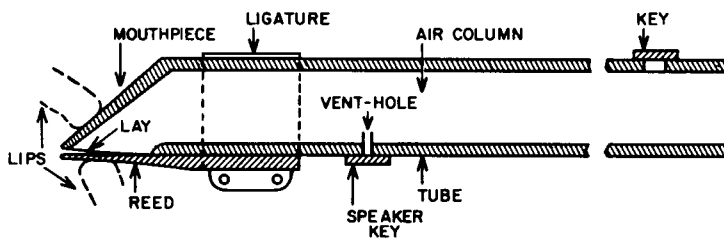

c) Cross-sectional view of the basic clarinet

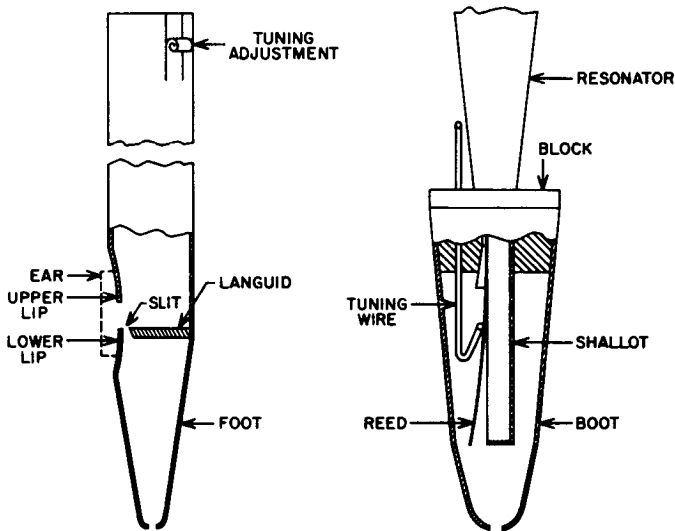

d) Organ pipes:
Left: *Diapason pipe*
Right: *Reed pipe*

Figure 4

We call this a **feedback** mechanism — reed oscillation and oscillation of the air column are influencing one another to keep a steady driving force at just the right frequency. In **double reed** instruments, like the oboe, two reeds are used instead of one. In **lip reed** instruments like the trumpet, the lips play the role of the flexible reeds. Yet another way to excite the air column is by an **air reed**: in instruments like certain organ pipes and the recorder, air is blown through a narrow slit called the **flue** (Fig. 4a). The airstream is directed toward a sharp edge, where the air stream is deflected by turbulence to oscillate back and forth, causing an **edge tone** (Fig. 4b). The

flute has no flue, but rather the narrow slit made by the lips of the flutist replaces the flue.

For all these instruments, the tone quality depends on the Fourier spectrum of the reed oscillations *and* on the resonances of the air column which are being excited by the reed. Wind instruments have *formants*, i.e., frequency regions which are reinforced by resonance, just like voices.

A. Excitation Mechanism

- Inspect the organ pipes and the wind instruments we have in the lab. Identify which ones are single reed, double reed, air reed and lip reed instruments.
- In brass instruments, the lips of the player form a vibrating double reed and act as a tone generator. Remove the mouth piece from a brass instrument and clean it with alcohol. Try to blow it.
- Try to vary the frequency by changing the embouchure, i.e., by changing the pressure on the lips and the speed of air flow.

*Embouchure is a French word, derived from **bouche** = mouth, which refers to the way one blows into a wind instrument.*

- Experience the effect of feedback on the lip reed: attach the mouth piece to the instrument and blow it again – can you still vary the frequency at will?

B. Length of Pipe

- How long an open pipe is needed to play a fundamental frequency which corresponds to middle C of the piano? Use the pipe formula to calculate the length. Look up the frequency of C (A=440 tempered scale) in Table 2 of Lab 10, Musical Scales (p. 74).
- Compare your calculation to the length of the flute which you find in the lab.
- Measure the length of the recorder (open pipe) and figure out the fundamental frequency. The recorder we have is an “Alto Recorder” — what tone of the musical scale does it play if all fingerholes are closed?

6. Wind Instruments II

A. Natural Scale

The bugle has no valves or keys, but the player can produce different modes by adjusting the pressure on the lips and the rate of air flow. Bugle compositions, by necessity, are limited to tones whose frequencies are multiples of the fundamental. The sequence of tones whose frequencies are $2f$, $3f$, $4f$, $5f$ etc. are called the *natural scale*. The lowest frequency, $1f$, can usually not be produced. If we assume that the fundamental frequency (mode #1) corresponds to the tone C_3 , the tones for the higher modes are:

1	2	3	4	5	6	8	9	10
C_3	C_4	G_4	C_5	E_5	G_5	C_6	D_6	E_6

Other instruments that are limited to the natural scale are the Bach trumpet, the natural horn, and the Alphorn.

- When you swing the corrugated pipe at different speeds, you hear the tones of the natural scale — try it. To get the fundamental frequency requires care.
- Mark the keys which correspond to the natural scale with pieces of tape on the keyboard in the lab and play a bugle tune, such as “Taps”.

B. Changing the Length of the Pipe with Valves

The pitch of the trombone is changed by changing the length of the pipe with a slide. For most other brass instruments, the pitch can be changed in steps of a semitone by opening valves which route the air into additional lengths of piping (see Fig. 5b, c).

- Measure the lengths of the additional tubing section on the trumpet or French horn. These lengths can be added to the length of the air column by depressing the valve.
- Compare the added length for each of the three valves to the overall length, and figure out how many semitones each added tube section corresponds to. Remember that it takes a 6% increase in length to reduce the frequency by a semitone.

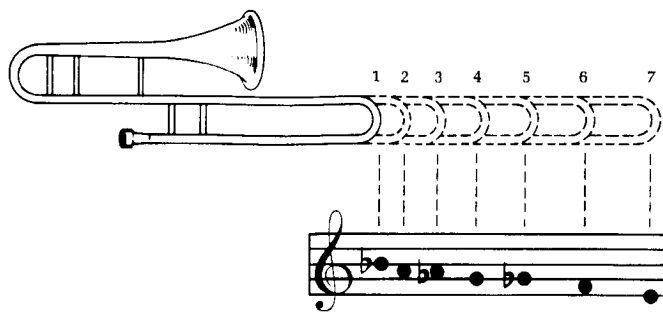

a) The trombone slide positions

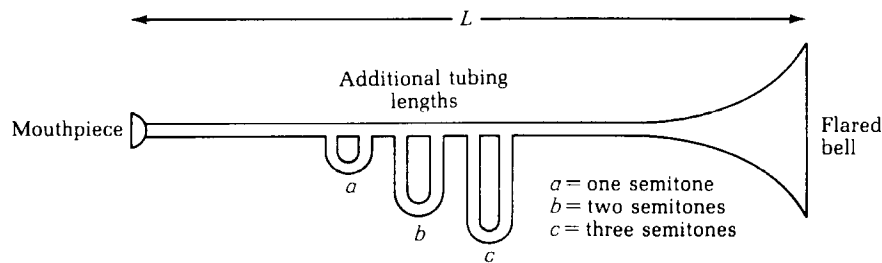

b) Diagram of additional tubing in brass instruments. The valves are not shown.

Figure 5 a, b

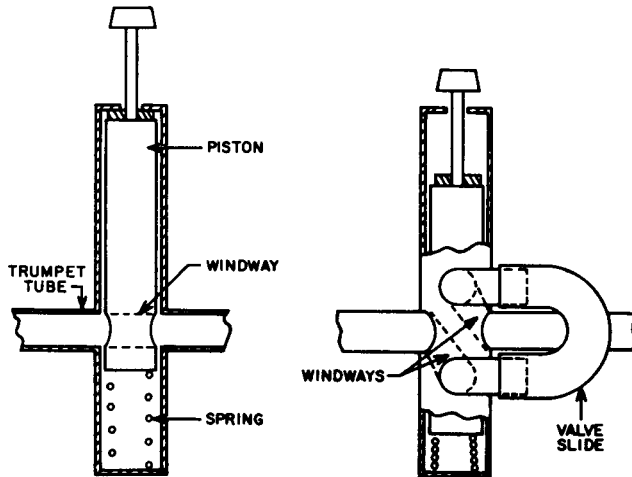

c) Structure of a trumpet valve—
 Left: Piston up
 Right: Piston down

Figure 5c

Now we will figure out how trumpets and horns can be made to play all tones of the piano keyboard, i.e. all twelve semitones of the scale. If you look at the tones of the natural scale listed above, you will note that the biggest problem is to bridge the large gap from G_4 (mode #3) to C_4 (mode #2).

- How many semitones are there from C_4 to G_4 ?
- Suppose you play G_4 (mode #3) and now want to lower the pitch in semitone steps until you get to C_4 . You have available three valves, (a) (b) and (c). When the valve (“piston” in Fig 5c) is depressed, it adds a certain length of pipe (Fig 5b). Pressing valve (a) lowers the pitch one semitone, valve (b) lowers the pitch two semitones and valve (c) lowers the pitch three semitones. If we indicated a depressed valve by x , and a not depressed valve by o , make a table of valve settings to play all the semitones from G_4 to C_4 (including G_4 but not including C_4).

7. Tympani (Kettle Drum)

Just like strings and pipes have modes, so do vibrating objects which extend over *two dimensions*, except that they can show more complicated vibration patterns. For a circular drum head, the lowest modes are shown in Fig. 6, where the dotted lines indicate the *nodes*, i.e. the places where the drum head does *not* move. Just as we found for strings and pipes, the actual motion is the superposition of the different modes. Here again, one can preferentially excite one mode or the other by hitting the drum head in different places, and by lightly touching the drum head in one place or another to suppress certain modes, just as we learned for strings.

- Inspect the kettle drum. Listen to the sound as you strike the drum head near the center and off to one side.

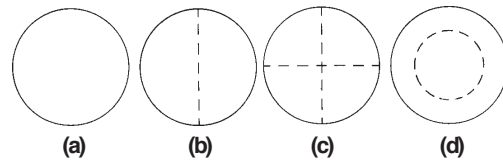

Vibrational modes of a stretched membrane.
 (a) Fundamental f ; (b) $f_1=1.59f$; (c) $f_2=2.13f$; $f_3=2.29f$.

Figure 6

- Which modes are strong if you hit the drum head in the center? Where would you want to hit the drum head for the first asymmetric mode (Fig. 6b) to be excited?
- Do kettle drums have a discernible pitch? Does the pitch change when you strike the membrane in different places?
- To see the oscillations of the different modes more clearly, you can try to sprinkle sand on the drum head and find the nodal lines.

Oscillations of the drum head are much more obvious if you use a rubber membrane instead of a normal drum head.

Appendix: Using the Oscilloscope

The oscilloscope is a powerful tool for analyzing electronic signals. You'll be using the oscilloscope to look at audio signals in the pipes lab and the musical scales lab. For these labs you'll need to use a few simple features labeled in the figure below and can safely ignore the myriad other buttons.

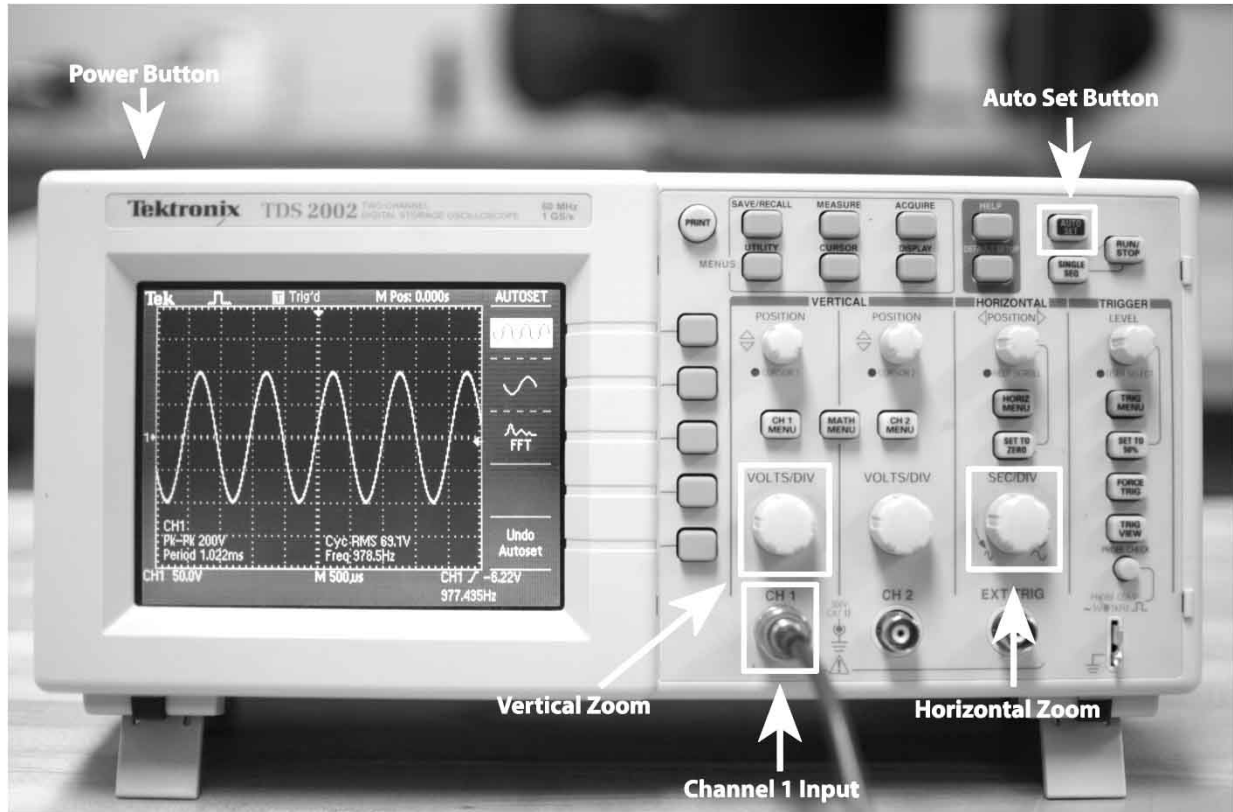

Press the **Power Button** and wait just a minute for the oscilloscope to boot. Plug your signal source into the **Channel 1 Input** using a cable with an end that looks like the picture to the right.



Once the scope is booted, press the **Auto Set Button** at the top right of the panel. This will ask the scope to detect the features of the signal source and set up the scope automatically. The figure shows a signal displayed using the Auto Set button.

Now you can 'zoom' the horizontal and vertical axes to see whatever feature interests you. The **Vertical Zoom** is controlled by the Volts/Div knob immediately above the Channel 1 Input. The **Horizontal Zoom** is controlled by the Sec/Div knob. Turning the knobs clockwise will zoom 'in' and counter-clockwise will zoom out.

That's it! If you ever get into trouble and lose the signal, don't panic. Just press the Auto Set button again and it will take you back to a good starting spot. If you have trouble beyond that, just ask your TA.